



QUANTUM<sup>®</sup>  
STORAGE  
SYSTEMS

**LOWEST  
PRICE  
GUARANTEE**



## THE STORAGE & ORGANIZATION EXPERTS

- ▶ **BINS**
- ▶ **WIRE SHELVING**
- ▶ **MOBILE CARTS**
- ▶ **COMPLETE BIN SYSTEMS**
- ▶ **TRASH CANS**
- ▶ **MEDICAL & FOOD GRADE CONTAINERS**



Located in Miami, Florida, Quantum is one of the largest injection molding companies with 75 molding presses. We offer **the largest selection of storage and organization products in the industry**. Injection molding the highest quality bins and containers in the industrial, material handling, hardware industries, healthcare, hospitality, food service, janitorial & sanitation, Quantum is the leader in providing organization and complete storage solutions.

## OUR MISSION

First Class Quality

Product Always in Stock

Pre & Post Order Customer Care

Guaranteed Low Prices

- ▶ *Our facility is over 1.5 million square feet in manufacturing and distribution space with over 550 employees.*
- ▶ *Our manufacturing and distribution facilities run 24 hours a day, 7 days a week. We supply over 70,000,000 storage bins worldwide annually.*
- ▶ *Offering over 25,000 product skus to our customers, Quantum stocks each item in our Florida and Illinois warehouses. 99% of products are available to ship within 24 hours from receipt of order.*
- ▶ *Quantum plastic products are all manufactured using FDA approved materials as well as products meeting NSF requirements for the healthcare and food service industries.*

## SUPPLYING OVER 70,000,000 BINS WORLDWIDE ANNUALLY



- ▶ Huge Inventories
- ▶ Same and Next Day Shipping
- ▶ Multiple Shipping Locations

## ULTRA BINS & SYSTEMS

4	Ultra Stack & Hang Bins
5	Ultra Stack & Hang Bins
6	Mesh Stack & Hang Bins
7	Wire Louvered Panels
8	Louvered Panels
9	Louvered Panels & Bench Racks
10	Louvered Racks
11	Hanging Rail Systems
12	Complete Package Systems
13	IRONMAN 22 Gauge Steel Shelving
14	Giant Open Hopper Steel Shelving Systems
15	Giant Open Hopper Wire Shelving Systems
16	Heavy-Duty 36" All-Welded Bin Cabinets
17	Heavy-Duty 36" & 48" Specialty Bin Cabinets
18	Heavy-Duty 48" All-Welded Bin Cabinets
19	Heavy-Duty All-Welded Cabinets & Rail Cart
20	Heavy-Duty 60" & 72" All-Welded Bin Cabinets
21	Crystal Clear Ultra Stack and Hang Bins <b>NEW</b>

## CLEAR-VIEW BINS

22	Ultra Bins & Shelving Systems
23	Ultra Bin Systems
24	HULK 24" Containers & Shelving Systems
25	Giant Stack Containers & Shelving Systems
26	Economy 4" Shelf Bins & Shelving Systems
27	Economy 4" Shelf Bin Shelving Systems
28	Store-More 6" Shelf Bins & Shelving Systems
29	Store-More 6" Shelf Bin Shelving Systems
30	Store-Max 8" Shelf Bins
31	Store-Max 8" Shelf Bin Shelving Systems
32	Genuine stack and nest totes
33	Dividable Grid Containers & Shelving Systems

## BINS, TOTES & CONTAINERS

34	Stackable Shelf Bins
35	Stackable Shelf Bin Shelving Systems
36	HULK 24" Containers
37	HULK 24" Container Steel Shelving Systems
38	HULK 24" Container Wire Shelving Systems
39	HULK 30" & 36" Containers
40	HULK 30" Container Wire Shelving Systems
41	HULK 36" Container Wire Shelving Systems
42	RackBin 42" Containers
43	RackBin 42" Container Wire Shelving Systems
44	Giant Stack Containers
45	Giant Stack Container Storage Center
46	Giant Stack Container Wire Shelving Systems
47	MAGNUM Bins
48	MAGNUM Bin Steel Shelving Systems
49	MAGNUM Bin Wire Shelving Systems
50	Economy 4" Shelf Bins
51	Economy 4" Shelf Bin Steel Shelving Systems
52	Economy 4" Shelf Bin Sloped Shelving Systems
53	Economy 4" Shelf Bin Wire Shelving Systems
54	High Density Wire Shelving Systems
55	Store-More 6" Shelf Bins
56	Store-More 6" Shelf Bin Steel Shelving Systems
57	Store-More 6" Shelf Bin Sloped Shelving Systems
58	Store-More 6" Shelf Bin Wire Shelving Systems
59	Store-Max 8" Shelf Bins
60	Store-Max 8" Shelf Bin Steel Shelving Systems
61	Store-Max 8" Shelf Bin Wire Shelving Systems
62	Super Tuff Euro Drawers
63	Super Tuff Euro Drawer Steel Shelving Systems
64	Super Tuff Euro Drawer Sloped Shelving Systems
65	QuickPick Bins & Wire Shelving Systems
66	Smooth Wall Storage Boxes <b>NEW</b>
67	All Purpose Tubs and Utility Bins <b>NEW</b>
68	Latch Containers & Wire Shelving System
69	Dividable Grid Containers
70	Genuine stack and nest totes
71	Wire Shelving Systems
72	Cross Stack Tubs & QuanTub Nesting Tote
73	Tub Racks
74	Stacker Straight Wall Containers
75	Attached Top Distribution Containers
76	Collapsible Bulk Box
77	Removable Tray Trucks

78	MAGNUM Bin Transport Trucks
79	Polymer Utility Carts & Tool Rack
80	Tool Caddy & Box, Economy Nesting Bin, Wrench Holder
81	Labels

## SPECIALTY

82	Plastic Drawer Cabinets
83	Mobile Organizers
84	Clear Compartment Storage Boxes
85	Recycled Bins
86	Conductive Bins & Hanging Systems
87	Conductive Shelf Bins & Wire Shelving Systems
88	Conductive Dividable Grid Containers & Bin Carts
89	Conductive Wire Utility Carts, Trays & Tray Carts
90	Computer Work Center, Reel & Stencil Shelving Units
91	Clear Tip Out Bins
92	Dividable & Individual Clear Tip Out Bins & 669 Bin Set
93	Clear Tip Out Bin Rails & Frames
94	Clear Tip Out Bin Floor Stands
95	Mobile Clear Tip Out Bin Floor Stands
96	Clear Tip Out Bin Free Standing
97	Clear Tip Out Bin Gondola Slider Systems
98	Interlocking Storage Cabinets
99	Interlocking Storage Cabinet Floor Stands

## WIRE

100	Warranty & Shelving Finishes
101	Shelving Finishes
102	Shelving Systems
103	Shelving Systems
104	Wire Shelves
105	Posts
106	54" Wire Shelving Units
107	63" Wire Shelving Units
108	74" Wire Shelving Units
109	86" Wire Shelving Units
110	Solid Shelving
111	Solid Shelves & Posts
112	Galvanized Steel Solid Shelving Units
113	Galvanized Steel Solid Shelving Units
114	Stainless Steel Solid Shelving Units
115	Stainless Steel Solid Shelving Units
116	Polymer Wire Shelves & Posts <b>NEW</b>
117	Polymer Wire Shelving Units <b>NEW</b>
118	Convenient 1 Box Chrome Wire Shelving Units <b>NEW</b>
119	Convenient 1 Box Polymer Wire Shelving Units <b>NEW</b>
120	Corner Wire Shelving
121	Reel Shelving Units
122	Wire Utility & Therapy Cart
123	Push Handle Wire Utility Carts <b>NEW</b>
124	Cart Covers
125	Stem Caster Carts
126	Enclosure Carts
127	Enclosure Carts
128	Enclosure Carts
129	Security Units
130	High Density Sliding Floor Track System
131	High Density Sliding Floor Track System
132	High Density Sliding Overhead Track System
133	High Density Sliding Overhead Track System
134	Slanted Shelf Carts
135	Slanted Shelf Carts
136	Bin Carts
137	Double & Triple Bay Bin Carts
138	Modular Wire Stacking Baskets
139	Wire Basket Units
140	Post Baskets & Mobile Units
141	Labels
142	PARTition Wall Systems
143	PARTition Wall Systems
144	PARTition Wall Systems
145	PARTition Wall Systems - Accessories
146	PARTition Store Pull Out Basket Carts
147	PARTition Store Double Bay Carts - Accessories
148	Store Grid Mount Systems
149	Store Grid Mount Systems
150	Store Grid Mount Systems
151	Store Grid Mount Systems

152	Store Grid Mount Systems
153	Store Grid Mount Systems
154	Store Grid Mount Systems - Accessories
155	Wall Mount Cantilever Systems
156	Wall Mount Cantilever Systems
157	Wall Mount Cantilever Systems
158	Dunnage & Platform Racks
159	Dunnage & Platform Racks
160	Cantilevers & Dunnage Shelves
161	Shelves & Frames
162	Modular Trays & Tray Carts
163	Wire Shelving - Accessories
164	Wire Shelving - Accessories
165	Wire Shelving - Accessories
166	Wire Shelving - Accessories
167	Wire Shelving - Accessories

## MILLENNIA **NEW**

168	Millenia Shelving Systems
169	Millenia Shelving Systems
170	Millenia Shelves & Posts
171	Millenia Vented Shelf Units
172	Millenia Solid Shelf Units
173	Millenia Mix Shelf Units
174	Millenia - Accessories
175	Millenia - Accessories
176	Millenia Drying Racks
177	Millenia Convenient 1 Box Shelving

## MEDICAL

178	Hamper & Sterile Wrap Carts
179	Stainless Steel Carts & Tables
180	Catheter Carts
181	Garment Racks & Patient Apparel Cart
182	Bin Transport Carts

## FOOD SERVICE **NEW**

183	Polymer Dunnage Racks
184	Wine Cradle Shelves, Units & Carts
185	Wine Cantilevers, Bulk & Security Units
186	Organizers & Drive-Thru Station
187	Stainless Steel Shelf Covers & Custom Station
188	Drying & Can Rack Units
189	Drying & Can Rack Units - Accessories

## JANSAN **NEW**

190	Crusader Round Trash Cans
191	Crusader Round Trash Cans
192	Crusader Thin Trash Cans
193	Crusader Thin Recycling Containers

194	Layout & Consultative Services
195	Support
196	Index
197	Index
198	Index
199	Index

## WHY QUANTUM?



**RELIABLE IN-STOCK INVENTORY**



**SUPER FAST-SAME & NEXT DAY SHIPMENTS**



**LAYOUT & DESIGN SERVICES INCLUDED**



**LARGEST SELECTION OF WIRE & BINS**

Ultra Stack & Hang Bins



**PERFORMANCE FEATURES:**

- Available in 22 sizes
- Standard colors: Blue, Green, Ivory, Red, Yellow, Black and Clear  
 Stone and Crystal Clear color are available in select sizes  
 (additional colors available on request, subject to upcharge and minimum run quantity)
- Bins are made from heavy-duty, virgin grade, high density FDA approved polypropylene
- Large label slot provide easy label insertion and parts' identification
- Extra wide stacking ledge ensures stability for high stacking
- Reinforced design adds strength and prevents spreading of side walls
- Will not rust or corrode, unaffected by weak acids and alkalis, and are waterproof
- Autoclavable up to 250°F

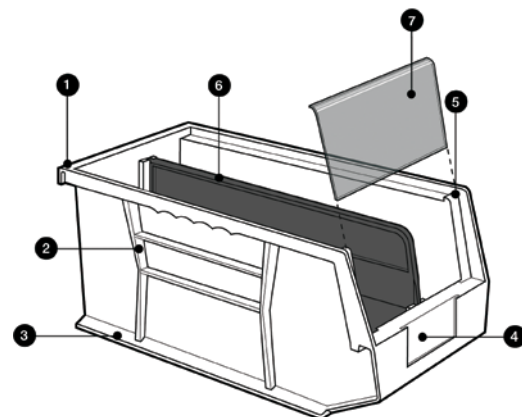

- 1 Full width hanger supports bin when hanging from louvered panels or rails
- 2 Reinforced rib design adds strength and prevents spreading of side walls
- 3 Extra-wide stacking ledge for secure stacking
- 4 Large front label slot allows larger bar code scanning and content identification
- 5 Anti-slide stop prevents stacked bins from shifting forward
- 6 Optional dividers increase storage options
- 7 Optional windows maximize storage capacity, prevent spillage and protect parts from dust and dirt



**QUS230 with COV230**

Lid pivots up and down via insertion in holes in rear of bin  
 (Sold separately)



**QUS239CL and QUS240**

Shown with optional clear window front and dividers in clear or black  
 (Sold separately)



**MOBILE ULTRA BIN**

Ideal for transport of heavy and bulky parts. Bin comes with 4 swivel, 3" polyurethane casters, all with brakes, allowing up to 250 lb. mobile load capacity



**CLEAR LABEL HOLDER**

Clear label holders and laser label inserts slide into front label slot of all bins.  
 (Sold in packages of 25)

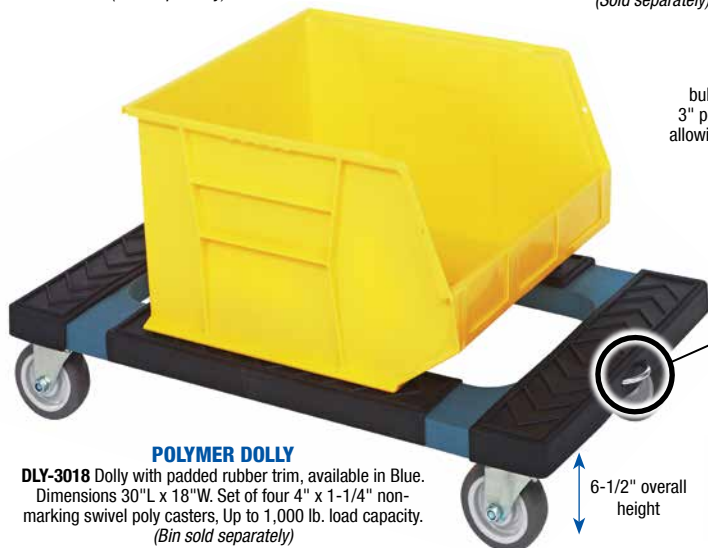

**POLYMER DOLLY**

**DLY-3018** Dolly with padded rubber trim, available in Blue. Dimensions 30"L x 18"W. Set of four 4" x 1-1/4" non-marking swivel poly casters, Up to 1,000 lb. load capacity.  
 (Bin sold separately)

6-1/2" overall height



**ATTACHED PULL RING**  
 Allows dolly to be pulled with ease



MODEL NO.	DESCRIPTION	CTN WGT
<b>DLY-3018</b>	Dolly with Padded Rubber Trim	19 lbs
<b>HANDLE-DLY</b>	32" Dolly Pull Rod with Handle	2 lbs

Bins sold separately

32" Dolly Pull Rod with handle  
 Finish: Chrome

**NEW**  
**CRYSTAL CLEAR**

**22 SIZES AND 9 COLORS AVAILABLE**  
**THE LARGEST SELECTION ANYWHERE!**

**CLEAR BINS**  
AVAILABLE VIEW

**QUS241**



**QUS242**



**QUS210**



**NEW**

**QUS210CC**  
Crystal Clear color  
in select sizes

**QUS230**  
Shown with optional  
Clear Lid



**QUS234**



**QUS238**



**QUS255**



**QUS260**



**QUS224**

**QUS221**  
Shown with optional  
Clear Divider



**QUS239**  
Shown with optional  
Black Divider



**QUS240**



**QUS248**



**QUS265**



**QUS235**

**QUS245**  
Shown with optional  
Clear Window and Black Divider



**QUS250**



**QUS270**  
Shown with optional  
Clear Window



**QUS232**

**QUS236**

**Ultra Stack & Hang Bins**



**HEAVY-DUTY**  
**LIFETIME USE**

**Bin Dimensions Guide**  
L (length) W (width) H (height)  
X (inside bottom length)

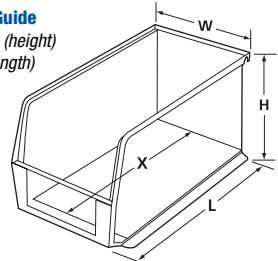

Organize your inventory with these strong bins, manufactured with FDA approved materials. Front, back and side grips for easy handling. Built-in rear hanger allows bins to hang from louvered panels or rails. Optional clear injection molded crystal styrene window front increases bin capacity and provides quick view of bin contents. Dividers, available in black or clear, maximize flexibility and keep contents organized. Wide stacking ledge and anti-slide lock keep stacked bins steady and prevent forward shifting. Water, rust, and corrosion proof. Easily cleaned with soap and water and impervious to most chemicals. Large molded front label slots for ID labels. Autoclavable up to 250°F and resistant to extreme cold. Guaranteed not to break or crack under normal load conditions.

Available in: ● Blue ● Green ● Ivory ● Red ● Yellow ● Black ● Clear  
**QUS210, QUS220, QUS224, QUS230, QUS234, QUS240, QUS250, QUS265, QUS270** also available in: ● Stone  
**QUS210, QUS220, QUS230, QUS240** also available in: ○ Crystal Clear

MODEL NO.	OUTSIDE DIMENSIONS L" x W" x H"	INSIDE DIMENSIONS L" x W" x H"	X"	CTN QTY	CTN WGT	BIN LOAD CAPACITY*	CLEAR WINDOW	CTN QTY	***DIVIDER & CROSS DIVIDER	CTN QTY	DIVIDER SLOTS	CLEAR LABEL HOLDER & INSERT	CLEAR LID	CTN QTY
<b>QUS210</b>	5-3/8" x 4-1/8" x 3"	4-3/4" x 3-7/16" x 2-13/16"	4"	24	6 lbs	15 lbs	-	-	<b>DUS210</b>	6	1	<b>LTR-1300</b>	<b>COV210</b>	24
<b>QUS220</b>	7-3/8" x 4-1/8" x 3"	6-3/4" x 3-7/16" x 2-13/16"	6"	24	8 lbs	15 lbs	-	-	<b>DUS220</b>	6	1	<b>LTR-1300</b>	<b>COV220</b>	24
<b>QUS221</b>	9-1/4" x 6" x 5"	8-1/2" x 5-1/8" x 4-1/2"	7-1/4"	12	6 lbs	25 lbs	<b>WUS221</b>	12	<b>DUS221</b>	6	1	<b>LTR-1754</b>	-	-
<b>QUS224</b>	10-7/8" x 4-1/8" x 4"	10-1/4" x 3-3/16" x 3-3/4"	9"	12	8 lbs	35 lbs	<b>WUS224</b>	12	<b>DUS224</b>	6	1	<b>LTR-1253</b>	<b>COV224</b>	12
<b>QUS230</b>	10-7/8" x 5-1/2" x 5"	10-1/4" x 4-3/8" x 4-3/4"	9"	12	10 lbs	35 lbs	<b>WUS230/234</b>	12	<b>DUS230/235</b>	6	1	<b>LTR-1754</b>	<b>COV230</b>	12
<b>QUS232</b>	5-3/8" x 11" x 3"	4-3/4" x 10-1/8" x 2-13/16"	4"	8	5 lbs	35 lbs	-	-	<b>DUS210</b>	6	3	<b>LTR-1300</b>	<b>COV232</b>	8
<b>QUS234</b>	14-3/4" x 5-1/2" x 5"	14-1/16" x 4-3/8" x 4-3/4"	12-13/16"	12	14 lbs	55 lbs	<b>WUS230/234</b>	12	<b>DUS234</b>	6	1	<b>LTR-1754</b>	-	-
<b>QUS235</b>	10-7/8" x 11" x 5"	10-1/4" x 10" x 4-3/4"	9"	6	10 lbs	55 lbs	<b>WUS235</b>	6	<b>DUS230/235</b>	6	3	<b>LTR-1754</b>	<b>COV235</b>	6
<b>QUS236</b>	7-3/8" x 11" x 3"	6-3/4" x 10-1/8" x 2-13/16"	6"	8	9 lbs	35 lbs	-	-	<b>DUS220</b>	6	3	<b>LTR-1300</b>	<b>COV236</b>	8
<b>QUS238</b>	18" x 5-1/2" x 5"	17-1/8" x 4-3/8" x 4-3/4"	15-7/8"	12	16 lbs	45 lbs	<b>WUS230/234</b>	12	<b>DUS238 CRDUS238</b>	6	1	<b>LTR-1754</b>	<b>COV238</b>	12
<b>QUS239</b>	10-3/4" x 8-1/4" x 7"	10" x 6-9/16" x 6-3/4"	8"	6	10 lbs	55 lbs	<b>WUS239/240</b>	6	<b>DUS239</b>	6	1	<b>LTR-1754</b>	<b>COV239</b>	6
<b>QUS240</b>	14-3/4" x 8-1/4" x 7"	14" x 6-9/16" x 6-3/4"	12"	12	24 lbs	65 lbs	<b>WUS239/240</b>	6	<b>DUS240/250</b>	6	1	<b>LTR-1754</b>	<b>COV240</b>	12
<b>QUS241</b>	13-5/8" x 8-1/4" x 6"	12-1/2" x 6-3/4" x 5-3/8"	11-1/8"	12	22 lbs	65 lbs	<b>WUS241</b>	12	<b>DUS241</b>	6	1	<b>LTR-1754</b>	-	-
<b>QUS242</b>	13-5/8" x 8-1/4" x 8"	12-1/2" x 6-3/4" x 7-3/8"	11-1/8"	12	25 lbs	65 lbs	<b>WUS242</b>	12	<b>DUS242</b>	6	1	<b>LTR-1754</b>	-	-
<b>QUS245</b>	10-7/8" x 16-1/2" x 5"	9-3/4" x 15" x 4-3/4"	9"	6	13 lbs	65 lbs	<b>WUS245</b>	6	<b>DUS245</b>	6	3	<b>LTR-1754</b>	-	-
<b>QUS248</b>	18" x 8-1/4" x 7"	17" x 6-1/2" x 6-1/2"	15-1/4"	6	19 lbs	80 lbs	<b>WUS239/240</b>	6	<b>DUS248 CRDUS248</b>	6	1	<b>LTR-1754</b>	<b>COV248</b>	6
<b>QUS250</b>	14-3/4" x 16-1/2" x 7"	14" x 14-3/4" x 6-3/4"	12"	6	21 lbs	80 lbs	<b>WUS250</b>	6	<b>DUS240/250</b>	6	3	<b>LTR-1754</b>	-	-
<b>QUS255</b>	16" x 11" x 8"	15-1/8" x 10" x 7-3/4"	11-5/8"	4	14 lbs	80 lbs	<b>WUS255</b>	4	<b>DUS255</b>	6	3	<b>LTR-1754</b>	-	-
<b>QUS260</b>	18" x 11" x 10"	17" x 9-1/2" x 9-3/4"	14-3/16"	4	17 lbs	80 lbs	<b>WUS260</b>	4	<b>DUS260</b>	6	3	<b>LTR-1754</b>	-	-
<b>QUS265</b>	18" x 8-1/4" x 9"	17-1/8" x 6-3/4" x 8-1/4"	14-1/2"	6	17 lbs	65 lbs	<b>WUS265</b>	6	<b>DUS265</b>	6	1	<b>LTR-1754</b>	-	-
<b>QUS270</b>	18" x 16-1/2" x 11"	17-1/8" x 14-3/4" x 10-1/4"	14"	3	16 lbs	80 lbs	<b>WUS270</b>	3	<b>DUS270 CRDUS270</b>	6	3	<b>LTR-2400</b>	-	-
<b>QUS275MOB**</b>	18" x 16-1/2" x 11"	17-1/8" x 14-3/4" x 10-1/4"	14"	3	25 lbs	-	<b>WUS270</b>	3	<b>DUS270 CRDUS270</b>	6	3	<b>LTR-2400</b>	-	-

\*When attached to panels or rails \*\*With casters, overall height is 14" \*\*\*To order clear dividers add **CL** suffix to divider (e.g. Model No. DUS210CL). To order a full carton add **CS** suffix to (e.g. Model No. QUS210GNCS). Note: Bins must be ordered in carton quantities only.

# 12 SIZES AVAILABLE



**Exclusive!** Mesh Stack & Hang Bins



New patented wire Mesh Bins are an industry exclusive. Our innovative mesh design offers a bright-chrome finish and a 3/8" x 3/8" grid pattern allowing complete visibility of the bin's contents. This unique mesh pattern provides a dust and dirt free storage environment. Ultra strong design allows for superior hang capacity perfect for industrial parts storage or anything where hang capacities are vital. Quantum's Mesh Bins feature a rear hanger that allows them to hang from any louvered wall panel or rail system and optional side stacking ledge which allow bins to stack one on top of the other. The open hopper design allows for easy picking while allowing visual access to stored contents. Two styles of optional label holders are available for all Mesh Bins. **Finish:** Chrome

MODEL NO.	OUTSIDE DIMENSIONS L" x W" x H"	INSIDE DIMENSIONS L" x W" x H"	CTN QTY	CTN WGT	SIDE STACKING LEDGE SOLD PER PAIR	DIVIDER
QMB510C	5-1/4" x 4-1/4" x 3"	4-3/4" x 3" x 2-3/4"	20	12 lbs	HMB510C	DMB510C
QMB520C	7-1/4" x 4-1/4" x 3"	6-3/4" x 3" x 2-3/4"	20	15 lbs	HMB520C	DMB520C
QMB524C	11" x 4-3/4" x 4"	10-3/8" x 3-1/2" x 3-3/4"	20	20 lbs	HMB530C/535C	DMB524C
QMB530C	10-3/4" x 5-1/2" x 5"	10-1/4" x 4" x 4-3/4"	10	12 lbs	HMB530C/535C	DMB530C/535C
QMB534C	15" x 6" x 5"	14-1/4" x 4-3/4" x 4-3/4"	10	17 lbs	HMB540C/550C	DMB534C
QMB535C	10-3/4" x 11" x 5"	10-1/4" x 9-3/4" x 4-3/4"	10	19 lbs	HMB530C/535C	DMB530C/535C
QMB539C	10-1/2" x 8" x 7"	10" x 6-5/8" x 6-5/8"	10	20 lbs	HMB539C	DMB539C
QMB540C	14-1/2" x 8" x 7"	14" x 6-5/8" x 6-5/8"	10	30 lbs	HMB540C/550C	DMB540C/550C
QMB550C	14-1/2" x 16-1/4" x 7"	14" x 14-7/8" x 6-5/8"	5	17 lbs	HMB540C/550C	DMB540C/550C
QMB560C	18-1/2" x 11" x 10-1/8"	18" x 9-5/8" x 9-7/8"	5	21 lbs	HMB560C/570C	DMB560C/570C
QMB565C	17-3/4" x 8-1/8" x 9"	17-1/8" x 5-1/4" x 8-3/4"	5	19 lbs	HMB565C	DMB565C
QMB570C	18-1/2" x 17-1/8" x 11-1/8"	18" x 15-5/8" x 10-7/8"	5	28 lbs	HMB560C/570C	DMB560C/570C

To order a full carton add **CS** suffix to Model No. QMB510CCS. **Note:** Bins must be ordered in carton quantities only.



**REAR HANGER**  
All Mesh Bins have a super strong rear hanger that allows hanging from a Louvered Panel or Rail System

**Up to 125 lb.**  
HANGING LOAD CAPACITY

**STACKING MESH BINS**  
Shown with optional Hanging Label Tag & Side Stacking Ledge  
Mesh Bins can easily stack one on top of another with optional Side Stacking Ledges (Sold separately)

**Up to 300 lb.**  
STACKING LOAD CAPACITY

**2 LABEL HOLDER OPTIONS**



Shown with optional **Divider**  
(Sold separately)



Shown with optional **Side Stacking Ledge Pair**  
(Sold separately)

**Accessories**

**INSTANT VISIBILITY  
NO DUST OR DIRT  
BUILDUP  
ALL WELDED**



Shown with optional **HBL3C Clear Label Holder**  
Fits 1-1/8" x 3" Label  
(Sold separately)

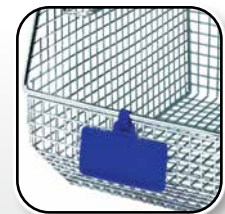

Shown with optional **PS-LH3 Hanging Label Tag**  
Fits 1-3/8" x 3" Label

- CL ● RD ● YL ● BL ● GN
- OR ● PU (Sold separately)

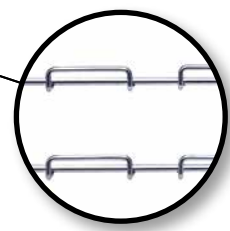

**WLP-1836C**  
36" L x 18" H

Accepts all sizes of Ultra Stack & Hang Bins and Mesh Bins. Includes 8 direct mount clips. Up to 175 lb. load capacity.

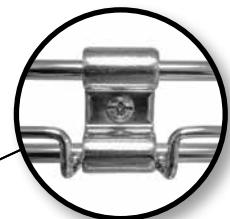

**WLP-3036C**  
36" L x 30" H

Accepts all sizes of Ultra Stack & Hang Bins and Mesh Bins. Includes 12 direct mount clips. Up to 250 lb. load capacity.

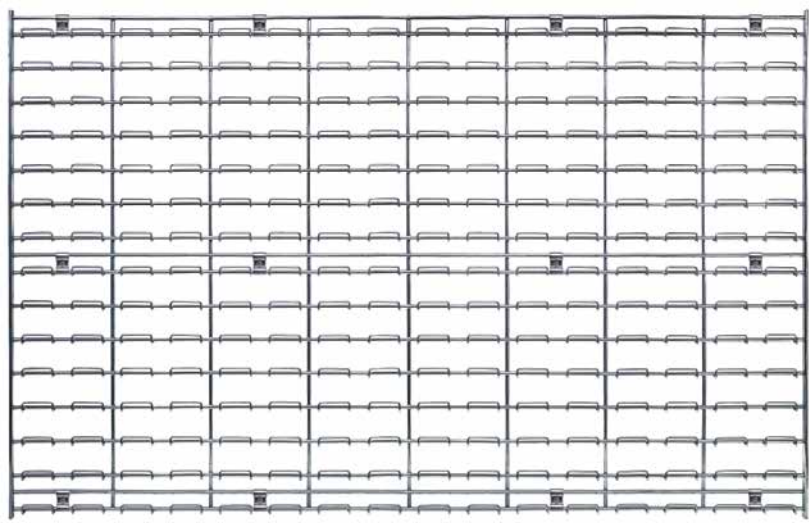

**Exclusive! Wire Louvered Panels**



Quantum's chrome Wire Louvered Panels offer a perfect mounting solution for all plastic hanging and wire mesh hanging bins. Quantum's exclusive offering of wire panels, available in three sizes, completely resist any buildup of dust or dirt. Included direct mounting clips enable fastening to any surface (*wall, wood, concrete, drywall, etc.*) a snap (**note: mounting screws are not included as they differ based on what type of surface the panels are being mounted to**). Offset mounting clips are also available, can be used in place of **WLP-DMC** if you want to have wire panel mounted offset (*away*) from a wall surface making it easier to clean behind the panel (*sold separately*). Manufactured of heavy-duty chrome wire, Quantum's wire panels will offer years of dependable and heavy-duty service.

MODEL NO.	DIMENSIONS L" x H"	CTN QTY	CTN WGT
<b>Wire Wall Mounted Louvered Panels</b>			
<b>WLP-1836C</b>	36" x 18" Wire Louvered Panel	1	12 lbs
<b>WLP-3036C</b>	36" x 30" Wire Louvered Panel	1	19 lbs
<b>WLP-3048C</b>	48" x 30" Wire Louvered Panel	1	26 lbs

**Accessories**



**WLP-DMC**

**Direct Mount Clips - 4 pack**  
(Included with wire louvered panels)  
Extra packages available (if needed). (Sold separately)



**WLP-OSC**

**Offset Mount Clips - 4 pack**  
Offsets panel from wall surface allowing easy access to clean behind panel  
(Sold separately)

**WLP-3048C**  
48" L x 30" H

Accepts all sizes of Ultra Stack & Hang Bins and Mesh Bins. Includes 12 direct mount clips. Up to 300 lb. load capacity.

**SIMPLE TO MOUNT  
EASY TO CLEAN  
ALL WELDED**

MODEL NO.	QUANTITY OF MESH BINS TO FIT LOUVERED PANELS												QUANTITY OF ULTRA BINS TO FIT LOUVERED PANELS																				
	QMB 510	QMB 520	QMB 524	QMB 530	QMB 534	QMB 535	QMB 539	QMB 540	QMB 550	QMB 560	QMB 565	QMB 570	QUS 210	QUS 220	QUS 221	QUS 224	QUS 230	QUS 232	QUS 234	QUS 235	QUS 236	QUS 238	QUS 239	QUS 240	QUS 241	QUS 242	QUS 245	QUS 248	QUS 250	QUS 255	QUS 260	QUS 265	QUS 270
<b>WLP-1836C</b>	32	32	18	18	18	9	8	8	4	3	4	2	32	32	18	18	18	12	18	9	12	18	8	8	8	8	6	8	4	6	3	4	2
<b>WLP-3036C</b>	56	56	30	30	30	15	16	16	6	6	8	6	56	56	30	30	30	21	30	15	21	30	16	16	16	16	10	16	6	9	6	8	6
<b>WLP-3048C</b>	77	77	40	40	40	20	20	20	8	12	15	6	77	77	40	40	40	28	40	20	28	40	20	20	20	20	10	20	8	12	12	15	6

See pgs. 5 & 6 for bin dimensions

**Hanging Louvered Panels**



Quantum Ultra and Mesh Bins will hang on louvered panels in a wide range of configurations designed to meet all application needs. Panels are formed from heavy-duty 16 gauge cold rolled steel and have a Gray or Oyster White powder coat finish which ensures years of heavy-duty use. Louvered panels may be mounted on any suitable wall surface. Fasten securely to assure adequate load bearing. Mounting hardware is not included.

MODEL NO.	DIMENSIONS L" x H"	CTN QTY	CTN WGT
<b>Gray Wall Mounted Louvered Panels</b>			
QLP-1819	18" x 19" Gray Louvered Panel	1	6 lbs
QLP-1861	18" x 61" Gray Louvered Panel	1	21 lbs
QLP-2721	27-3/4" x 21" Gray Louvered Panel	1	11 lbs
QLP-3612	36" x 12" Gray Louvered Panel	1	8 lbs
QLP-3619	36" x 19" Gray Louvered Panel	1	13 lbs
QLP-3661	36" x 61" Gray Louvered Panel	1	40 lbs
QLP-4819	48" x 19" Gray Louvered Panel	1	18 lbs
QLP-4861	48" x 61" Gray Louvered Panel	1	60 lbs
<b>Oyster White Wall Mounted Louvered Panels</b>			
QLP-1819HC	18" x 19" Oyster White Louvered Panel	1	6 lbs
QLP-1861HC	18" x 61" Oyster White Louvered Panel	1	21 lbs
QLP-3619HC	36" x 19" Oyster White Louvered Panel	1	13 lbs
QLP-3661HC	36" x 61" Oyster White Louvered Panel	1	40 lbs
QLP-4861HC	48" x 61" Oyster White Louvered Panel	1	60 lbs



**QLP-1819**  
18" L x 19" H

Accepts all sizes of Ultra and Mesh Bins.  
Up to 175 lb. load capacity. *(Bins sold separately)*

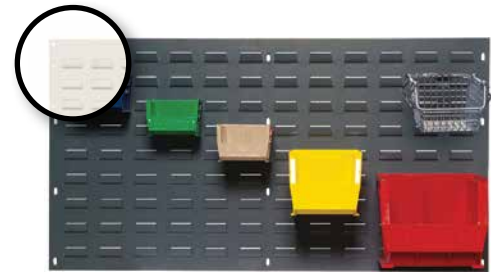

**QLP-3619**  
36" L x 19" H

Accepts all sizes of Ultra and Mesh Bins.  
Up to 200 lb. load capacity. *(Bins sold separately)*



**QLP-1861**  
18" L x 61" H

Accepts all sizes of Ultra and Mesh Bins.  
Up to 500 lb. load capacity. *(Bins sold separately)*



**QLP-3612**  
36" L x 12" H

Accepts all sizes of Ultra and Mesh Bins.  
Up to 175 lb. load capacity. *(Bins sold separately)*



**QLP-4861**  
48" L x 61" H

Accepts all sizes of Ultra and Mesh Bins.  
Up to 1,000 lb. load capacity.

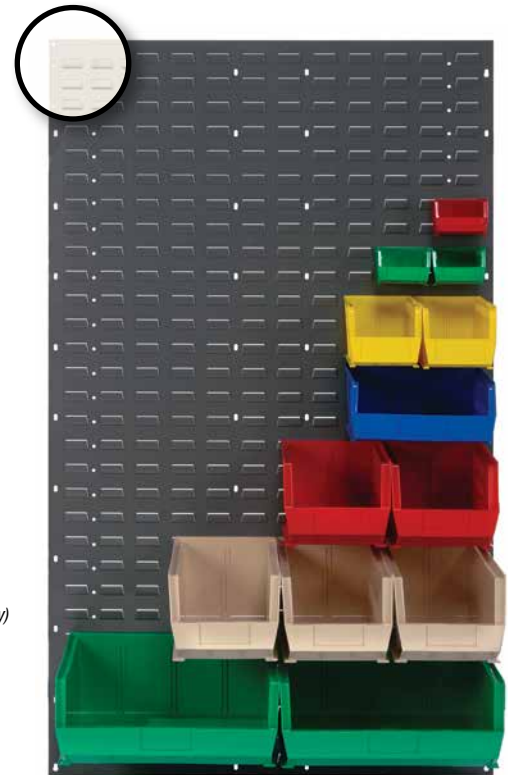

**QLP-3661**  
36" L x 61" H

Accepts all sizes of Ultra and Mesh Bins.  
Up to 1,000 lb. load capacity. *(Bins sold separately)*

**OFFERED IN GRAY OR OYSTER WHITE COLOR**



**QLP-4819**  
48" L x 19" H

Accepts all sizes of Ultra and Mesh Bins.  
Up to 250 lb. load capacity. *(Bins sold separately)*

**LOAD CAPACITIES INDICATED REQUIRE PANELS TO BE AFFIXED TO WALL CSTUDS**

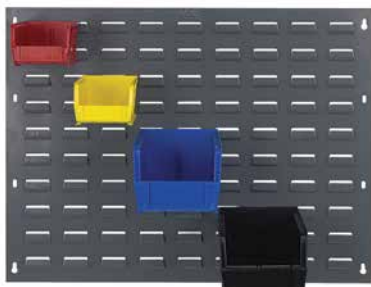

**QLP-2721**  
27-3/4"L x 21"H  
Accepts all sizes of Ultra and Mesh Bins.  
Up to 175 lb. load capacity. (Bins sold separately)



**QBR-3619**  
36"L X 8"W x 19"H  
Accepts all sizes of Ultra and Mesh Bins.  
Up to 150 lb. load capacity. (Bins sold separately)



**QBR-3612**  
36"L X 8"W x 12"H  
Accepts all sizes of Ultra and Mesh Bins.  
Up to 125 lb. load capacity. (Bins sold separately)



**QBR-1819**  
18"L X 8"W x 19"H  
Accepts all sizes of Ultra and Mesh Bins.  
Up to 140 lb. load capacity. (Bins sold separately)

**Accessories**

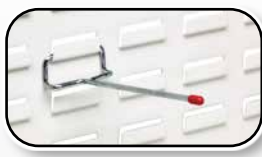

**WS-SR9C**  
9" Single Rod  
Up to 15 lb. load capacity



**WS-DR10C**  
10" Double Rod  
Up to 15 lb. load capacity



**WS-VTH**  
Vertical Tape/Reel Holder  
Up to 25 lb. load capacity



**WS-HDS6**  
Heavy-Duty 6" Spike  
Up to 65 lb. load capacity



**WS-HDS12**  
Heavy-Duty 12" Spike  
Up to 50 lb. load capacity

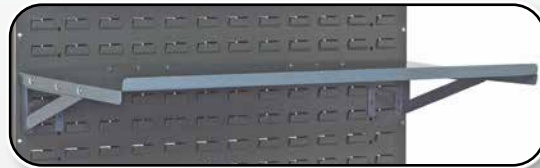

**SLP-1236 (12"D x 36"W) and SLP-1836 (18"D x 36"W)**  
Flat Shelf with 2 Brackets. Available in 12" or 18" Depth.  
Up to 75 lb. load capacity



**SLP-A1236 (12"D x 36"W) and SLP-A1836 (18"D x 36"W)**  
Slanted Shelf with 2 Slanted Brackets. Available in 12" or 18" Depth.  
Up to 75 lb. load capacity



**WS-HTH**  
Horizontal Tape/Reel Holder  
Up to 25 lb. load capacity

**CUSTOMIZE YOUR OWN UNIT**

1. Select the hanging unit of your choice.
2. Turn to pg. 5 and pg. 6 to choose the bin that best fits your need.
3. Go to the chart at the bottom of this page and determine how many bins fit on the unit you selected.
4. Place your order for both unit and bins.

**Bench Racks**

MODEL NO.	DIMENSIONS L" x W" x H"	CTN QTY	CTN WGT
<b>QBR-1819</b>	18" x 8" x 19" Bench Rack	1	11 lbs
<b>QBR-2721</b>	27-3/4" x 8" x 21" Bench Rack	1	16 lbs
<b>QBR-3612</b>	36" x 8" x 12" Bench Rack	1	14 lbs
<b>QBR-3619</b>	36" x 8" x 19" Bench Rack	1	19 lbs

MODEL NO.	QUANTITY OF MESH BINS TO FIT LOUVERED PANELS											QUANTITY OF ULTRA BINS TO FIT LOUVERED PANELS																						
	QMB 510	QMB 520	QMB 524	QMB 530	QMB 534	QMB 535	QMB 539	QMB 540	QMB 550	QMB 560	QMB 565	QMB 570	QUS 210	QUS 220	QUS 221	QUS 224	QUS 230	QUS 232	QUS 234	QUS 235	QUS 236	QUS 238	QUS 239	QUS 240	QUS 241	QUS 242	QUS 245	QUS 248	QUS 250	QUS 255	QUS 260	QUS 265	QUS 270	
<b>QLP-1819</b>	16	16	12	9	9	3	4	4	2	1	4	1	16	16	9	12	9	6	9	3	6	9	4	4	4	4	3	4	2	1	1	4	1	
<b>QLP-1861</b>	60	60	30	30	30	15	14	14	7	5	12	5	60	60	30	30	30	15	30	15	15	30	14	14	14	14	14	10	4	7	7	5	12	5
<b>QLP-2721</b>	30	30	12	12	12	6	6	6	2	4	6	1	30	30	12	12	12	10	12	6	10	12	6	6	6	6	3	14	2	4	4	6	1	
<b>QLP-3612</b>	18	18	12	12	12	6	4	4	2	3	8	2	18	18	12	12	12	9	12	6	9	12	4	4	4	4	6	2	6	3	8	2		
<b>QLP-3619</b>	40	40	24	18	18	9	8	8	4	3	8	2	40	40	18	24	18	12	18	9	12	18	8	8	8	6	4	4	6	3	8	2		
<b>QLP-3661</b>	120	120	80	60	60	30	28	28	14	15	24	10	120	120	60	80	60	45	60	30	45	60	28	28	28	28	20	8	14	21	15	24	10	
<b>QLP-4819</b>	55	55	24	24	24	12	10	10	4	8	10	2	55	55	24	24	24	16	24	12	16	24	10	10	10	10	6	28	4	8	8	10	2	
<b>QLP-4861</b>	165	165	80	80	80	40	35	35	14	20	30	10	165	165	80	80	80	60	80	40	60	80	35	35	35	35	20	10	14	28	20	30	10	
<b>QBR-1819</b>	16	16	12	9	9	3	4	4	2	1	4	1	16	16	9	12	9	6	9	3	6	9	4	4	4	4	3	35	2	1	1	4	1	
<b>QBR-2721</b>	30	30	12	12	12	6	6	6	2	4	6	1	30	30	12	12	12	10	12	6	10	12	6	6	6	6	3	6	2	4	4	6	1	
<b>QBR-3612</b>	18	18	12	12	12	6	4	4	2	3	8	2	18	18	12	12	12	9	12	6	9	12	4	4	4	4	4	4	2	6	3	8	2	
<b>QBR-3619</b>	32	32	32	18	18	9	8	8	4	3	8	2	32	32	18	32	18	12	18	9	12	18	8	8	8	8	6	8	4	6	3	8	2	

See pgs. 5 & 6 for bin dimensions



**QSS-3666H**  
Single Sided Louvered Rack

36"L x 12-1/2"W x 66"H  
Up to 800 lb. capacity. Single sided unit accepts all sizes of Ultra and Mesh Bins (up to 120 bins)  
Shown with QUS240 and QUS250 bins.  
(Bins sold separately)



**QDS-3666H**  
Double Sided Louvered Rack

36"L x 25"W x 66"H  
Up to 2,000 lb. capacity. Mobile unit accepts all sizes of Ultra and Mesh Bins (up to 240 bins)  
Shown with QUS235 bins.  
(Bins sold separately)



**QMD-36H**  
Mobile Double Sided Louvered Rack

36"L x 25"W x 72"H  
Up to 1,200 lb. capacity. Mobile unit accepts all sizes of Ultra and Mesh Bins (up to 240 bins). Comes complete with four 5" hard rubber, heavy-duty casters, 2 swivel with brake and 2 rigid. Easy-to-pull handle included.  
Shown with QUS230 and QUS240 bins.  
(Bins sold separately)



**QSS-1866H**  
Single Sided Louvered Rack

18"L x 12-1/2"W x 66"H  
Up to 375 lb. capacity. Single sided unit accepts all sizes of Ultra and Mesh Bins (up to 60 bins).  
Shown with QUS245 bins.  
(Bins sold separately)

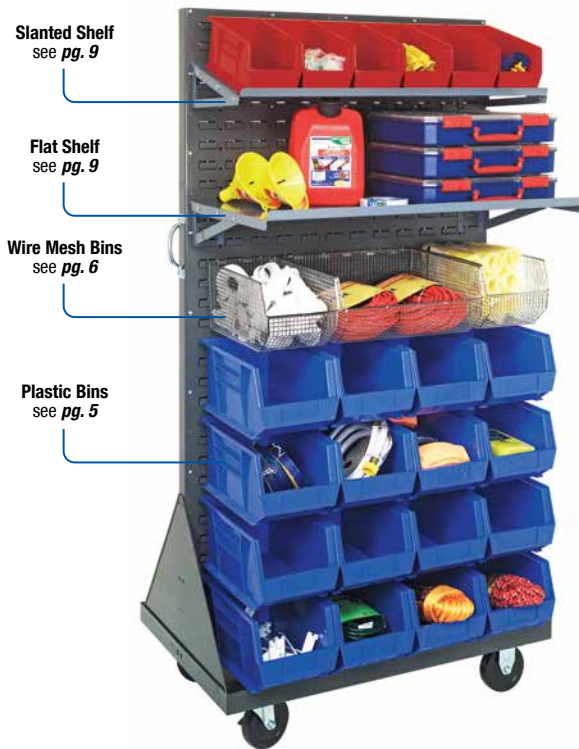

Slanted Shelf  
see pg. 9

Flat Shelf  
see pg. 9

Wire Mesh Bins  
see pg. 6

Plastic Bins  
see pg. 5

**CUSTOMIZE YOUR OWN UNIT**

1. Select the hanging unit of your choice.
2. Turn to pg. 5 and pg. 6 to choose the bin that best fits your need.
3. Go to the chart at the bottom of this page and determine how many bins fit on the unit you selected.
4. Place your order for both unit and bins.

**Louvered Racks**



MODEL NO.	BIN DIMENSIONS L" x W" x H"	CTN QTY	CTN WGT
<b>Single Sided Unit - Up To 375 lb. Capacity</b>			
QSS-1866H	18"L x 12-1/2"W x 66"H	1	40 lbs
<b>Single Sided Unit - Up To 800 lb. Capacity</b>			
QSS-3666H	36"L x 12-1/2"W x 66"H	1	60 lbs
<b>Double Sided Unit - Up To 2,000 lb. Capacity</b>			
QDS-3666H	36"L x 25"W x 66"H	1	106 lbs
<b>Double Sided Unit - Mobile Unit - Up To 1,200 lb. Capacity</b>			
QMD-36H	36"L x 25"W x 72"H	1	155 lbs

**QUANTITY OF ULTRA BINS TO FIT LOUVERED RACKS**

MODEL NO.	QUS 210	QUS 220	QUS 221	QUS 224	QUS 230	QUS 232	QUS 234	QUS 235	QUS 236	QUS 238	QUS 239	QUS 240	QUS 241	QUS 242	QUS 245	QUS 248	QUS 250	QUS 255	QUS 260	QUS 265	QUS 270
QSS-1866H	60	60	30	30	30	15	30	10	15	30	15	14	14	10	14	10	7	5	12	5	
QSS-3666H	120	120	60	80	60	45	60	30	45	60	28	28	28	24	20	28	14	21	15	24	10
QDS-3666H	240	240	120	160	120	90	120	60	90	120	56	56	48	40	28	56	42	30	40	40	20
QMD-36H	240	240	120	160	120	90	120	60	90	120	56	56	48	40	28	56	42	30	40	40	20

See pg. 5 for bin dimensions



**Hang-n-Stack Bins - Complete Packages**

Comes with 2 handy 12" plastic rails ideal for mounting to any surface. Bins can hang or stack securely providing an efficient bin storage system. Bins available in Blue, Yellow, Red, Green, Ivory, Black and Clear. Rails available in White.

MODEL NO.	BIN DIMENSIONS L" x W" x H"	DESCRIPTION	CTN WGT
HNS210	5-3/8" x 4-1/8" x 3"	6 bins + 2 rails	2 lbs
HNS220	7-3/8" x 4-1/8" x 3"	6 bins + 2 rails	3 lbs
HNS230	10-7/8" x 5-1/2" x 5"	4 bins + 2 rails	5 lbs
HNS006	Extra Rails	2 rails	1 lb

**CUSTOMIZE YOUR OWN UNIT**

1. Select the hanging unit of your choice.
2. Turn to pg. 5 and choose the bin that best fits your need.
3. Go to the chart at the bottom of this page and determine how many bins fit on the unit you selected.
4. Place your order for both unit and bins.



Shown with 24 QUS240 bins.  
(Bins sold separately)

**QRU-12S**  
Single Sided Rack, 12 Rails  
36"L x 15"W x 53"H

Up to 600 lb. capacity. Accepts 12 sizes of Ultra Bins (up to 96 bins). See chart for bin configurations.

**QRU-16S**

Single Sided Rack, 16 Rails

Up to 600 lb. capacity. Accepts 6 sizes of Ultra Bins (up to 48 bins). See chart for bin configurations.



Shown with 192 QUS220 bins.  
(Bins sold separately)

**QRU-12D**  
Double Sided Rack, 12 Rails  
36"L x 20"W x 53"H

Up to 1,600 lb. capacity. Accepts 12 sizes of Ultra Bins (up to 192 bins). See chart for bin configurations.

**QRU-16D**

Double Sided Rack, 16 Rails

Accepts 6 sizes of Ultra Bins (up to 96 bins)  
Up to 1,600 lb. capacity. See chart for bin configurations.



**Steel Rail**

**GRAY OR OYSTER WHITE COLOR**



48"L x 5/8"W x 3"H Steel Rail mounts to any surface or workbench and accepts 13 sizes of Ultra bins (up to 11 bins per rail). Up to 125 lb. load capacity. Gray powder coat and oyster white finish.

MODEL NO.	DESCRIPTION	CTN QTY	CTN WGT
QRU-1W	48" Wall Rail	1	6 lbs
QRU-1WHC	48" Wall Rail Oyster White	1	6 lbs



Rails may be mounted on any suitable surface including walls, benches, inside service trucks and cabinets or on carts. Fasten securely to ensure proper load bearing. Configure Rail to meet your custom requirements. Mounting hardware is not included. (Bins sold separately)



Shown with 96 QUS230 bins.  
(Bins sold separately)

**QRU-16D + QRU-MOB**

Double Sided Rack, 16 Rails with Mobile Kit  
36"L x 20"W x 59"H

2 rigid, 1 swivel and 1 swivel with brake casters  
Up to 1,000 lb. capacity. Accepts 6 sizes of Ultra Bins (up to 96 bins). See chart for bin configurations.

**QRU-12D + QRU-MOB**

Double Sided Rack, 12 Rails with Mobile Kit  
2 rigid, 1 swivel and 1 swivel with brake casters  
Up to 1,000 lb. capacity. Accepts 12 sizes of Ultra Bins (up to 192 bins). See chart for bin configurations.

**QUANTITY OF ULTRA BINS TO FIT RAIL UNITS**

MODEL NO.	DESCRIPTION	DIMENSIONS L" x W" x H"	QUANTITY OF ULTRA BINS TO FIT RAIL UNITS																							
			QUS 210	QUS 220	QUS 221	QUS 224	QUS 230	QUS 232	QUS 234	QUS 235	QUS 236	QUS 238	QUS 239	QUS 240	QUS 241	QUS 242	QUS 245	QUS 248	QUS 250	QUS 255	QUS 260	QUS 265	QUS 270			
QRU-1W	48"L Steel Rail	48" x 5/8" x 3"	11	11	8	11	8	4	8	4	4	8	5	5	5	5	3	5	-	-	-	-	-			
QRU-12S	Rack, 1 sided 12 rail	36" x 15" x 53"	96	96	-	-	-	36	-	-	36	-	24	24	20	-	24	12	12	12	20	8	-			
QRU-16S	Rack, 1 sided 16 rail	36" x 15" x 53"	-	-	48	48	48	-	48	24	-	48	-	-	-	16	-	-	-	-	-	-	-			
QRU-12D	Rack, 2 sided 12 rail	36" x 20" x 53"	192	192	-	-	-	72	-	-	72	-	48	48	48	40	-	48	24	24	24	40	16			
QRU-16D	Rack, 2 sided 16 rail	36" x 20" x 53"	-	-	96	96	96	-	96	48	-	96	-	-	-	32	-	-	-	-	-	-	-			
QRU-MOB	Mobile Kit - Mobilizes Double Sided Units																									

See pg. 5 for bin dimensions



**Single & Double Sided Rail Systems - Complete Packages**

**Single Sided Systems:** 36"L x 15"W x 53"H offers up to 600 lb. load capacity. Available in 4 different configurations.

**Double Sided Systems:** 36"L x 20"W x 53"H offers up to 1,600 lb. load capacity. Available in 3 different configurations. Mobilize double sided system with the addition of **QRU-MOB**.



QRU-16S-220230240

**Bench Racks - Complete Packages**

27-3/4"L x 8"W x 21"H and 36"L x 8"W x 19"H Bench Racks are each available in 3 pre-configured choices. Bench Racks can be joined together to form continuous systems.



QBR-3619-210-32

**Louvered Panels - Complete Packages**

18"L x 19"H, 36"L x 19"H, 36"L x 61"H and 48"L x 61"H Louvered Panels are each available in 3 configurations. Louvered Panels are available in Gray or Oyster White color. To order an Oyster White Louvered Panel add **HC** to the model number (i.e. **QLP-1819HC-210-18**). Mounting hardware is not included.



QLP-1819-220-16

**Mobile Double Sided Louvered Rack Systems - Complete Packages**

36"L x 25"W x 72"H Mobile Double Sided Louvered Rack System offers up to 1,200 lb. load capacity. 2 rigid, 2 swivel with brake hard rubber casters.



QMD-36H-230240



Bins available in: ● Blue ● Green ● Ivory ● Red ● Yellow ● Black ● Clear (One color per unit)

MODEL NO.	NO. OF BINS	BIN DIMENSIONS L" x W" x H"	SHIP WGT
-----------	-------------	-----------------------------	----------

**36"L x 15"W x 53"H - Single Sided Rail Systems**

QRU-12S-220-96	96	7-3/8" x 4-1/8" x 3"	82 lbs
QRU-16S-230-48	48	10-7/8" x 5-1/2" x 5"	108 lbs
QRU-12S-240-24	24	14-3/4" x 8-1/4" x 7"	102 lbs
QRU-16S-220230240	16	7-3/8" x 4-1/8" x 3"	108 lbs
	18	10-7/8" x 5-1/2" x 5"	
12	14-3/4" x 8-1/4" x 7"		

**36"L x 20"W x 53"H - Double Sided Rail Systems**

QRU-12D-220-192	192	7-3/8" x 4-1/8" x 3"	113 lbs
QRU-16D-230-96	96	10-7/8" x 5-1/2" x 5"	155 lbs
QRU-12D-240-48	48	14-3/4" x 8-1/4" x 7"	153 lbs
QRU-MOB	Mobile Kit - Mobilizes Double Sided Systems		25 lbs

MODEL NO.	NO. OF BINS	BIN DIMENSIONS L" x W" x H"	SHIP WGT
-----------	-------------	-----------------------------	----------

**27-3/4"L x 8"W x 21"H - Bench Racks**

QBR-2721-210-24	24	5-3/8" x 4-1/8" x 3"	23 lbs
QBR-2721-220-24	24	7-3/8" x 4-1/8" x 3"	25 lbs
QBR-2721-230-12	12	10-7/8" x 5-1/2" x 5"	28 lbs

**36"L x 8"W x 19"H - Bench Racks**

QBR-3619-210-32	32	5-3/8" x 4-1/8" x 3"	29 lbs
QBR-3619-220-32	32	7-3/8" x 4-1/8" x 3"	31 lbs
QBR-3619-230-18	18	10-7/8" x 5-1/2" x 5"	37 lbs

MODEL NO.	NO. OF BINS	BIN DIMENSIONS L" x W" x H"	SHIP WGT
-----------	-------------	-----------------------------	----------

**18"L x 19"H - Louvered Panels**

QLP-1819-210-16	16	5-3/8" x 4-1/8" x 3"	11 lbs
QLP-1819-220-16	16	7-3/8" x 4-1/8" x 3"	12 lbs
QLP-1819-230-9	9	10-7/8" x 5-1/2" x 5"	16 lbs

**36"L x 19"H - Louvered Panels**

QLP-3619-210-32	32	5-3/8" x 4-1/8" x 3"	22 lbs
QLP-3619-220-32	32	7-3/8" x 4-1/8" x 3"	24 lbs
QLP-3619-230-18	18	10-7/8" x 5-1/2" x 5"	30 lbs

**36"L x 61"H - Louvered Panels**

QLP-3661-220-120	120	7-3/8" x 4-1/8" x 3"	80 lbs
QLP-3661-230-60	60	10-7/8" x 5-1/2" x 5"	90 lbs
QLP-3661-240-28	28	14-3/4" x 8-1/4" x 7"	96 lbs

**48"L x 61"H - Louvered Panels**

QLP-4861-220-165	165	7-3/8" x 4-1/8" x 3"	115 lbs
QLP-4861-230-80	80	10-7/8" x 5-1/2" x 5"	127 lbs
QLP-4861-240-35	35	14-3/4" x 8-1/4" x 7"	130 lbs

MODEL NO.	NO. OF BINS	BIN DIMENSIONS L" x W" x H"	SHIP WGT
-----------	-------------	-----------------------------	----------

**36"L x 25"W x 72"H - Mobile Double Sided Louvered Rack**

QMD-36H-220	240	7-3/8" x 4-1/8" x 3"	174 lbs
QMD-36H-230	120	10-7/8" x 5-1/2" x 5"	212 lbs
QMD-36H-240	56	14-3/4" x 8-1/4" x 7"	208 lbs
QMD-36H-230240	72	10-7/8" x 5-1/2" x 5"	217 lbs
	24	14-3/4" x 8-1/4" x 7"	

**COMPLETE PACKAGES WITH BINS**

**IRONMAN - Steel Shelving**

**Up to 400 lb.**  
**LOAD CAPACITY PER SHELF**



75-1836-6



39-1836-4

**22 GAUGE**  
**ALL-WELDED STEEL CONSTRUCTION**

**CLOSED SHELVING DUST FREE AND SECURE STORAGE**



CL39-1836-4



CL75-1836-6

MODEL NO.	SHELF D" x W"	SHIP WGT
<b>4 Shelf - 39"H - Open Shelving Unit</b>		
39-1236-4	12" x 36"	45 lbs
39-1836-4	18" x 36"	63 lbs
39-1842-4	18" x 42"	75 lbs
<b>5 Shelf - 39"H - Open Shelving Unit</b>		
39-1236-5	12" x 36"	53 lbs
39-1836-5	18" x 36"	75 lbs
39-1842-5	18" x 42"	81 lbs
<b>6 Shelf - 39"H - Open Shelving Unit</b>		
39-1236-6	12" x 36"	61 lbs
39-1836-6	18" x 36"	87 lbs
39-1842-6	18" x 42"	91 lbs
<b>4 Shelf - 75"H - Open Shelving Unit</b>		
75-1236-4	12" x 36"	55 lbs
75-1836-4	18" x 36"	69 lbs
75-1842-4	18" x 42"	85 lbs
<b>5 Shelf - 75"H - Open Shelving Unit</b>		
75-1236-5	12" x 36"	66 lbs
75-1836-5	18" x 36"	79 lbs
75-1842-5	18" x 42"	91 lbs
<b>6 Shelf - 75"H - Open Shelving Unit</b>		
75-1236-6	12" x 36"	73 lbs
75-1836-6	18" x 36"	89 lbs
75-1842-6	18" x 42"	101 lbs
<b>7 Shelf - 75"H - Open Shelving Unit</b>		
75-1236-7	12" x 36"	80 lbs
75-1836-7	18" x 36"	99 lbs
75-1842-7	18" x 42"	113 lbs
<b>8 Shelf - 75"H - Open Shelving Unit</b>		
75-1236-8	12" x 36"	87 lbs
75-1836-8	18" x 36"	109 lbs
75-1842-8	18" x 42"	125 lbs

**PERFORMANCE FEATURES:**

- Heavy-duty, high grade shelving units are easy to clean and will not rust or corrode
- Shelving Units are 39"H or 75"H and are available in three different shelf sizes
- Shelving has a smooth powder coat finish
- Up to 400 lb. shelf capacity
- Shelves assemble with 4 nuts and bolts per shelf

MODEL NO.	SHELF D" x W"	SHIP WGT
<b>4 Shelf - 39"H - Closed Shelving Unit</b>		
CL39-1236-4	12" x 36"	71 lbs
CL39-1836-4	18" x 36"	94 lbs
<b>5 Shelf - 39"H - Closed Shelving Unit</b>		
CL39-1236-5	12" x 36"	79 lbs
CL39-1836-5	18" x 36"	106 lbs
<b>6 Shelf - 39"H - Closed Shelving Unit</b>		
CL39-1236-6	12" x 36"	87 lbs
CL39-1836-6	18" x 36"	118 lbs
<b>4 Shelf - 75"H - Closed Shelving Unit</b>		
CL75-1236-4	12" x 36"	90 lbs
CL75-1836-4	18" x 36"	115 lbs
<b>5 Shelf - 75"H - Closed Shelving Unit</b>		
CL75-1236-5	12" x 36"	103 lbs
CL75-1836-5	18" x 36"	126 lbs
<b>6 Shelf - 75"H - Closed Shelving Unit</b>		
CL75-1236-6	12" x 36"	110 lbs
CL75-1836-6	18" x 36"	136 lbs
<b>7 Shelf - 75"H - Closed Shelving Unit</b>		
CL75-1236-7	12" x 36"	117 lbs
CL75-1836-7	18" x 36"	146 lbs
<b>8 Shelf - 75"H - Closed Shelving Unit</b>		
CL75-1236-8	12" x 36"	124 lbs
CL75-1836-8	18" x 36"	156 lbs

**Giant Open Hopper Steel Shelving Systems - Complete Packages**



These economical high density bin storage systems include heavy-duty giant stack bins with open hopper fronts for easy access. Optional clear window fronts maximize capacity, prevent spillage and convert the bin to a true tote. Optional dividers keep contents organized - available on **pg. 5**. Heavy-duty, industrial grade shelving with up to 400 lb. load capacity per shelf.

**22 GAUGE**  
ALL-WELDED STEEL CONSTRUCTION

**COMPLETE PACKAGES**  
WITH BINS

**12" Deep Systems**

**18" Deep Systems**



**QSBU-230240**

12"D x 36"W x 75"H  
10 shelves and 36 QUS230  
10-7/8"L x 5-1/2"W x 5"H bins  
and 12 QUS240  
14-3/4"L x 8-1/4"W x 7"H bins



**QSBU-239**

12"D x 36"W x 75"H  
8 shelves and 28 QUS239  
10-3/4"L x 8-1/4"W x 7"H bins



**QSBU-255**

18"D x 36"W x 75"H  
8 shelves and 21 QUS255  
16"L x 11"W x 8"H bins  
*(Windows sold separately)*



**QSBU-260**

18"D x 36"W x 75"H  
6 shelves and 15 QUS260  
18"L x 11"W x 10"H bins  
*(Windows and dividers sold separately)*



**QSBU-240**

12"D x 36"W x 75"H  
8 shelves and 28 QU240  
14-3/4"L x 8-1/4"W x 7"H bins



**QSBU-250**

12"D x 36"W x 75"H  
8 shelves and 14 QUS250  
14-3/4"L x 16-1/2"W x 7"H bins



**QSBU-265**

18"D x 36"W x 75"H  
7 shelves and 24 QUS265  
18"L x 8-1/4"W x 9"H bins



**QSBU-270**

18"D x 36"W x 75"H  
6 shelves and 10 QUS270  
18"L x 16-1/2"W x 11"H bins

Bins available in: ● Blue ● Green ● Ivory ● Red ● Yellow ● Black ● Clear *(One color per unit)*

**Giant Open Hopper Wire Shelving Systems - Complete Packages**

**CLEAR**  
VIEW  
BINS

AVAILABLE on pg. 22



**MOBILIZE YOUR WIRE SHELVING**

**DB - Donut Bumper**

Non-marking donut bumper used to protect walls and help cushion impact.

**WR-00H (Mobile Kit)\***

Set of four swivel thermoplastic resin 5" x 1-1/4" casters, two with brakes. Up to 1,200 lb. load capacity. \*Mobile kits recommended only for shelves 18" and deeper.

**COMPLETE PACKAGES WITH BINS**

**12" and 14" Deep Systems**

**18" Deep Systems**



**WR8-239**

12"W x 36"L x 74"H  
8 shelves and 28 QUS239  
10-3/4"L x 8-1/4"W x 7"H bins



**WR8-240**

14"W x 36"L x 74"H  
8 shelves and 28 QUS240  
14-3/4"L x 8-1/4"W x 7"H bins



**WR10-221**

**Kanban Bin System**  
18"W x 36"L x 74"H  
10 shelves and 90 QUS221  
9-1/4"L x 6"W x 5"H bins



**WR6-260**

18"W x 36"L x 74"H  
6 shelves and 15 QUS260  
18"L x 11"W x 10"H bins



**WR8-250**

14"W x 36"L x 74"H  
8 shelves and 14 QUS250  
14-3/4"L x 16-1/2"W x 7"H bins



**WR10-230240**

14"W x 36"L x 74"H  
10 shelves and 36 QUS230  
10-7/8"L x 5-1/2"W x 5"H bins and  
12 QUS240 14-3/4"L x 8-1/4"W x 7"H bins



**WR6-265**

18"W x 36"L x 74"H  
6 shelves and 20 QUS265  
18"L x 8-1/4"W x 9"H bins



**WR5-270**

18"W x 36"L x 74"H  
5 shelves and 8 QUS270  
18"L x 16-1/2"W x 11"H bins

Bins available in: ● Blue ● Green ● Ivory ● Red ● Yellow ● Black ● Clear (One color per unit)

36" Wide All-Welded Bin Cabinet



All-Purpose cabinets provide secure storage for your valuable parts and tools. Standard performance features: ships completely assembled, ready to use, 14 gauge all-welded construction, gray or beige powder-coated finish which ensures years of heavy-duty service, 3 point locking handle supplied with 2 keys. To order a Beige cabinet, add **BG** right after cabinet prefix (i.e. **QSC-BG-36** or **MESH-BG-240** or **QPR-BG-101**). See **pg. 5** for bin dimensions.



**QSC-36-68**

36"W x 24"D x 72"H. Deep Door model. Ship wt. 425 lbs. Total of **68** bins. 16 QUS232, 16 QUS236, 18 QUS230, 12 QUS240 and 6 QUS250.

**COMPLETE PACKAGES WITH BINS**

Also Available:

**QSC-36**  
Total of 132 bins.  
48 QUS210  
48 QUS220  
18 QUS230  
12 QUS240  
6 QUS250

Also Available:

**QSC-36S-38**  
Total of 38 bins.  
16 QUS232  
16 QUS236  
6 QUS250



**QSC-36S**

36"W x 24"D x 72"H. Deep Door model. Ship wt. 465 lbs. Total of **102** bins. 48 QUS210, 48 QUS220, 6 QUS250 and 3 adjustable shelves. Up to 800 lb. capacity per interior shelf.

**CABINETS NOW AVAILABLE WITH 2 BIN COMBINATIONS TO CHOOSE FROM**

(New wider bins on doors NOW AVAILABLE)



**QSC-64-2S-6DS**

36"W x 24"D x 72"H. Deep Door model. Ship wt. 427 lbs. Total of **64** bins. 48 QUS220, 16 QUS240, 2 adjustable interior shelves and 6 door shelves. Up to 800 lb. capacity per interior shelf. Up to 60 lb. capacity per door shelf.

Also Available:

**QSC-32-2S-6DS**  
Total of 32 bins.  
16 QUS236  
16 QUS240

Also Available:

**QSC-36-32-4IS**  
Total of 32 bins.  
32 QUS232



**QSC-36-96-4IS**

36"W x 24"D x 72"H. Deep Door model. Ship wt. 377 lbs. Total of **96** bins. 96 QUS210 and 4 adjustable interior shelves. Up to 800 lb. capacity per interior shelf.

**CABINETS AVAILABLE IN GRAY OR BEIGE COLOR**

**14 GAUGE ALL-WELDED STEEL CONSTRUCTION**

**CABINET ARRIVES FULLY ASSEMBLED READY TO USE**



**QSC-36-FD**

36"W x 18"D x 72"H. Flush Door model. Ship wt. 359 lbs. Total of **36** bins. 18 QUS230, 12 QUS240 and 6 QUS250.



**QSC-36-4IS-12DS**

36"W x 24"D x 72"H. Deep Door model. Ship wt. 308 lbs. 4 adjustable interior shelves and 12 door shelves. Up to 800 lb. capacity per interior shelf. Up to 60 lb. capacity per door shelf.

Bins available in: Blue Green Ivory Red Yellow Black Clear (One color per unit)

**QPR-101**

**Sloped Shelf Pick Rack Flow Cabinet**

36"W x 18"D x 78"H.

Flush Door model. Ship wt. 298 lbs.

Total of **72** bins. **Eight** sloped shelves

and **one** flat shelf total **72 QSB101** bins.

Additional cabinet configurations listed below.

Up to 400 lb. capacity per interior shelf.

MODEL NO.	NO. OF BINS	BIN MODEL NO.	SHIP WGT
<b>QPR-101</b>	72	QSB101	298 lbs
<b>QPR-102</b>	45	QSB102	294 lbs
<b>QPR-107</b>	36	QSB107	289 lbs

See **pg. 50** for bin dimensions



**CABINETS AVAILABLE IN GRAY OR BEIGE COLOR**



**QSC-36-MIN**

**Counter High Cabinet**

36"W x 24"D x 36"H.

Ship wt. 218 lbs. Total of **66** bins. **24 QUS210**, **24 QUS220**, **12 QUS230**, **4 QUS240** and **2 QUS250**. See **pg. 5** for bin dimensions.



**QSC-QIC161**

**Interlocking Drawer Storage Cabinet**

48"W x 24"D x 78"H.

Ship wt. 507 lbs. Total of **128** bins and **15** Interlocking Drawer Cabinets. Louvered door fits **128 QUS210** bins (see **pg. 5** for bin dimensions). Shelves hold **15** Interlocking Cabinet Units. Interlocking Cabinets have a Gray exterior. Drawers are available in Blue, Red, Ivory and Gray.

Door bins available in Blue, Green, Ivory, Red, Yellow, Black and Clear.

Up to 400 lb. capacity per interior shelf.

MODEL NO.	CABINET MODEL NO.	NO. OF DRAWERS	SHIP WGT
<b>QSC-QIC161</b>	QIC-161	240	507 lbs
<b>QSC-QIC122</b>	QIC-122	180	507 lbs
<b>QSC-QIC83</b>	QIC-83	120	492 lbs
<b>QSC-QIC64</b>	QIC-64	90	492 lbs

See **pg. 98** for cabinet and drawer dimensions

**MESH-240**

**Wire Mesh Safe-View Bin Cabinet**

36"W x 18"D x 78"H.

Mesh Door model. Ship wt. 290 lbs.

Total of **36** bins. Louvered back wall fits

**36 QUS240**. Additional cabinet configurations listed below.

MODEL NO.	NO. OF BINS	BIN MODEL NO.	SHIP WGT
<b>MESH-240</b>	36	QUS240	290 lbs
<b>MESH-240250</b>	20	QUS240	303 lbs
	8	QUS250	
<b>MESH-250</b>	18	QUS250	288 lbs

See **pg. 5** for bin dimensions

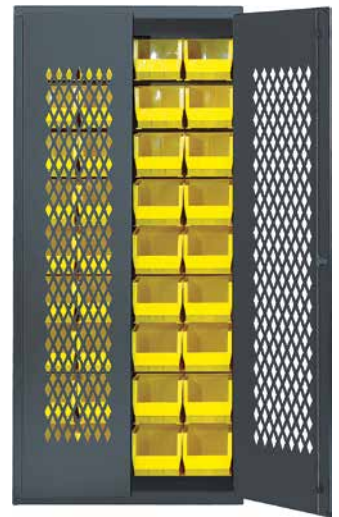

**COMPLETE PACKAGES WITH BINS**

**QSC-C240250**

**Clear-View Security Bin Cabinet**

36"W x 18"D x 78"H.

Clear Acrylic Door model. Ship wt. 388 lbs.

Total of **28** bins. Louvered back wall fits

**20 QUS240** and **8 QUS250**. Additional cabinet configurations listed below.

MODEL NO.	NO. OF BINS	BIN MODEL NO.	SHIP WGT
<b>QSC-C240</b>	36	QUS240	390 lbs
<b>QSC-C240250</b>	20	QUS240	388 lbs
	8	QUS250	
<b>QSC-C250</b>	18	QUS250	392 lbs

See **pg. 5** for bin dimensions



**QSC-3672-4D**

36"W x 24"D x 72"H.

Flush Door model. Ship wt. 663 lbs. Comes complete with **one** 18" deep adjustable shelf, **12** door shelves, **four** 31"W x 16"D drawers: **two** are 3" high, **one** is 5" high, **one** is 6" high. Total of **58** bins. **36 QUS220**, **18 QUS230** and **4 QUS240**.

Up to 800 lb. capacity per interior shelf. Up to 60 lb. capacity per door shelf.

See **pg. 5** for bin dimensions.

Bins available in: ● Blue ● Green ● Ivory ● Red ● Yellow ● Black ● Clear (One color per unit)

**48" Wide All-Welded Bin Cabinets**



These 48" wide models offer all of the features of the 36", but with additional storage space. All cabinets are also available in Beige color. To order a Beige cabinet, add **BG** right after cabinet prefix (i.e. **QSC-BG-48** or **MESH-BG-240** or **QPR-BG-101**). See **pg. 5** for bin dimensions.



**QSC-48**

48"W x 24"D x 78"H. Flush Door Model. Ship wt. 522 lbs. Total of **171** bins. **64 QUS210, 64 QUS220, 24 QUS230, 13 QUS240** and **6 QUS250**.

**CABINETS AVAILABLE IN GRAY OR BEIGE COLOR**



**QSC-48S**

48"W x 24"D x 78"H. Flush Door Model. Ship wt. 534 lbs. Total of **137** bins. **64 QUS210, 64 QUS220, 3 QUS240, 6 QUS250** and **3** adjustable shelves. Up to 400 lb. capacity per interior shelf.



**QSC-4803**

48"W x 24"D x 78"H. Flush Door Model. Ship wt. 505 lbs. Total of **128** bins. **128 QUS210** and **4** adjustable interior shelves. Up to 400 lb. capacity per interior shelf.

**COMPLETE PACKAGES WITH BINS**



**QSC-4804**

48"W x 24"D x 78"H. Flush Door Model. Ship wt. 515 lbs. Total of **84** bins. **20 QUS240, 64 QUS220, 2** adjustable interior shelves and **6** door shelves. Up to 400 lb. capacity per interior shelf. Up to 60 lb. capacity per door shelf.



**QSC-4805**

48"W x 24"D x 78"H. Flush Door Cabinet. Ship wt. 484 lbs. Total of **64** bins. **64 QUS210** and punched panels on inside rear wall and doors, **2** adjustable interior shelves. Up to 400 lb. capacity per interior shelf.

**PERFECT FOR JANITORIAL AND MAINTENANCE STORAGE**



**QSC-41S-14DS**

48"W x 24"D x 84"H. Deep Door Model. Ship wt. 572 lbs. **4** adjustable interior shelves and **14** adjustable door shelves. Up to 400 lb. capacity per interior shelf. Up to 60 lb. capacity per door shelf.

Bins available in: ● Blue ● Green ● Ivory ● Red ● Yellow ● Black ● Clear (One color per unit)

**48" Wide All-Welded Cabinet**



48" wide all-welded all purpose cabinet with 4 interior and adjustable shelves. Cabinet is also available in Beige color. To order Beige cabinet, add **BG** right after cabinet prefix (i.e. **QSC-BG-3IS**).



**QSC-3IS**

48"W x 24"D x 78"H. Flush Door model. Ship wt. 323 lbs.  
3 adjustable shelves. Up to 400 lb. capacity per shelf.

**CABINET AVAILABLE IN GRAY OR BEIGE COLOR**

**14 GAUGE**

**ALL-WELDED STEEL CONSTRUCTION**

**CABINET ARRIVES FULLY ASSEMBLED  
READY TO USE**

**Mobile Rail Cart**



Mobilize your parts and supplies with this ultra-convenient storage and transport cart. Eliminates lugging heavy bins or loading them onto a regular cart. Multiple bin configurations to choose from. Flat top with raised edges contains more equipment and doubles as a work surface. 16-gauge cold-rolled steel with a powder coated gray finish. All-welded steel push handle. Two rigid and two swivel poly casters with brake. Up to 800 lb. load capacity.



**Up to 800 lb.**  
**MOBILE LOAD CAPACITY**

**QRC-4D**

**Mobile Ergonomic Cart**  
36"L x 24"W x 35-1/2"H  
Up to 800 lb. load capacity.  
Accepts 6 sizes of Ultra Bins  
(up to 64 bins).  
Includes 2 rigid and 2 swivel,  
with brake, hard rubber casters.  
(Bins sold separately)

MODEL NO.	DESCRIPTION	QUS 210	QUS 220	QUS 230	QUS 235	QUS 239
<b>Quantity of Ultra Bins to Fit Rail Cart</b>						
<b>QRC-4D</b>	36" x 24" Rail Cart	64	64	48	24	16

See pg. 5 for bin dimensions

Bins available in: Blue Green Ivory Red Yellow Black Clear (One color per unit)

**Clear Tip Out Bin Cabinets**



**QSC-QTB36-35**

**Clear Tip Out Bin Small Cabinet**

26-1/4"W x 10"D x 36-1/2"H  
Total of 35 clear cups. 1 QTB304, 2 QTB305,  
2 QTB306, 1 QTB309. Available in Gray.  
Ship wt. 84 lbs.



**CABINETS AVAILABLE  
IN BEIGE COLOR**

**BOTH CABINETS HAVE  
A TOP AND BOTTOM  
HEAVY-DUTY DOOR  
AND COMBINATION LOCK**



**QSC-QTB79-61**

**Clear Tip Out Bin Tall Cabinet**  
26-1/4"W x 10"D x 79-1/2"H  
Total of 61 clear cups.  
3 QTB304, 5 QTB305, 4 QTB306.  
Available in Gray.  
Ship wt. 185 lbs.

- Fully welded strong construction
- Epoxy powder coating
- Metal hinges with 180° opening

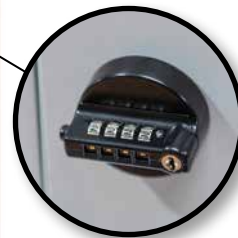

**COMBINATION LOCK**  
(Cabinet also comes with master key for combination override)

**Super-Wide Colossal Heavy-Duty Cabinets**



Super-Wide Colossal Cabinets offer 60" or 72" widths and 84" heights allowing for maximum and efficient storage while providing superior strength and security. Standard performance features: ships completely assembled, ready to use, 14 gauge all-welded construction, gray or beige powder-coated finish which ensures years of heavy-duty service, 3 point locking handle with provision for a padlock (*not included*) and 6" high legs make cabinets fork truck liftable. To order a Beige cabinet, add **BG** right after cabinet prefix (*i.e. QSC-BG-60 or MESH-BG-240 or QPR-BG-101*). See **pg. 5** for bin dimensions.

**115" WIDE WHEN DOORS ARE FULLY OPEN**



**QSC-60**  
60"W x 24"D x 84"H. Flush Door model. Ship wt. 860 lbs.  
Total of 227 bins. 80 QUS210, 90 QUS220, 30 QUS230,  
18 QUS240 and 9 QUS250.



**QSC-60S**  
60"W x 24"D x 84"H. Flush Door model. Ship wt. 878 lbs.  
Total of 185 bins. 80 QUS210, 90 QUS220, 6 QUS240, 9 QUS250  
and 3 adjustable shelves. Up to 500 lb. capacity per interior shelf.

**COMPLETE PACKAGES WITH BINS**

**CABINETS AVAILABLE IN GRAY OR BEIGE COLOR**

**139" WIDE WHEN DOORS ARE FULLY OPEN**

**72" CABINETS NOW AVAILABLE WITH 2 BIN COMBINATIONS TO CHOOSE FROM**

*(New wider bins on doors NOW AVAILABLE)*



**QSC-72**  
72"W x 24"D x 84"H. Flush Door model. Ship wt. 1,002 lbs.  
Total of 264 bins. 96 QUS210, 96 QUS220, 36 QUS230,  
24 QUS240 and 12 QUS250.

**Also Available:**  
**QSC-72-136**  
Total of 136 bins.  
32 QUS232  
32 QUS236  
36 QUS230  
24 QUS240  
12 QUS250



**Also Available:**  
**QSC-72S**  
Total of 212 bins.  
96 QUS210  
96 QUS220  
8 QUS240  
12 QUS250

**QSC-72S-84**  
72"W x 24"D x 84"H. Flush Door model. Ship wt. 955 lbs.  
Total of 84 bins. 32 QUS232, 32 QUS236, 8 QUS240, 12 QUS250  
and 3 adjustable shelves. Up to 500 lb. capacity per interior shelf.

Bins available in: ● Blue ● Green ● Ivory ● Red ● Yellow ● Black ● Clear *(One color per unit)*



LOWEST PRICE GUARANTEE

# CRYSTAL CLEAR ULTRA BINS

Introducing our revolutionary crystal clear hang and stack bin, a cutting-edge solution designed for any application where transparency is paramount, our product stands out as a game-changer

## CRYSTAL CLEAR



### HEAVY-DUTY LIFETIME USE

### CRYSTAL-CLEAR VISIBILITY

#### Crystal Clear Ultra Stack & Hang Bins



**NEW**

Our crystal clear hang and stack bins provides unparalleled clarity, allowing a direct and unobstructed view of products or materials. This transparency enhances safety and efficiency in all settings.

#### PERFORMANCE FEATURES:

- FDA approved clear thermoplastic
- Large label slot provide easy label insertion and parts identification
- Will not rust or corrode, unaffected by weak acids and alkalis, and are waterproof
- Autoclavable up to 250°F

Available in:  Crystal Clear

MODEL NO.	OUTSIDE DIMENSIONS L" x W" x H"	INSIDE DIMENSIONS L" x W" x H" X"	CTN QTY	CTN WGT	BIN LOAD CAPACITY*	CLEAR WINDOW	CTN **DIVIDER & QTY CROSS DIVIDER	CTN DIVIDER QTY	DIVIDER SLOTS	CLEAR LABEL HOLDER & INSERT	CLEAR LID	CTN QTY
QUS210CC	5-3/8" x 4-1/8" x 3"	4-3/4" x 3-7/16" x 2-13/16" 4"	24	6 lbs	15 lbs	-	- DUS210	6	1	LTR-1300	COV210	24
QUS220CC	7-3/8" x 4-1/8" x 3"	6-3/4" x 3-7/16" x 2-13/16" 6"	24	8 lbs	15 lbs	-	- DUS220	6	1	LTR-1300	COV220	24
QUS230CC	10-7/8" x 5-1/2" x 5"	10-1/4" x 4-3/8" x 4-3/4" 9"	12	10 lbs	35 lbs	WUS230/234	12 DUS230/235	6	1	LTR-1754	COV230	12
QUS240CC	14-3/4" x 8-1/4" x 7"	14" x 6-9/16" x 6-3/4" 12"	12	24 lbs	65 lbs	WUS239/240	6 DUS240/250	6	1	LTR-1754	COV240	12

\*When attached to panels or rails \*\*To order clear dividers add CL suffix to divider Model No. DUS210CL. To order a full carton add CS suffix to Model No. QUS210CCS. Note: Bins must be ordered in carton quantities only.

Clear-View Ultra Stack & Hang Bins



Organize your inventory with strong injection molded tri-clear virgin-grade polypropylene bins. Front, back and side grips for easy handling. Built in rear hanger allows bins to hang from louvered panels or rails. Optional clear injection molded crystal styrene window fronts increases bin capacity and provides quick view of bin contents. Dividers maximize flexibility and keep contents organized. Wide stacking ledge and anti-slide lock keep stacked bins steady and prevent forward shifting. Waterproof bins resist rust and corrosion. Large molded front label slots for ID labels. Autoclavable up to 250°F and resistant to extreme cold.



QUANTUM IS CLEARLY YOUR STORAGE SOLUTION

See pg. 5 for accompanying dividers, clear lids, clear window fronts and clear label holders.



MOBILIZE YOUR WIRE SHELVING

DB - Donut Bumper

Non-marking donut bumper used to protect walls and help cushion impact.

WR-00H (Mobile Kit)\*

Set of four swivel thermoplastic resin 5" x 1-1/4" casters, two with brakes. Up to 1,200 lb. load capacity. \*Mobile kits recommended only for shelves 18" and deeper.

COMPLETE PACKAGES WITH BINS



WR8-240CL



QSBU-240CL

Available in:  Clear

MODEL NO.	OUTSIDE DIMENSIONS L" x W" x H"	CTN QTY	CTN WGT
QUS210CL	5-3/8" x 4-1/8" x 3"	24	6 lbs
QUS220CL	7-3/8" x 4-1/8" x 3"	24	8 lbs
QUS221CL	9-1/4" x 6" x 5"	12	6 lbs
QUS224CL	10-7/8" x 4-1/8" x 4"	12	8 lbs
QUS230CL	10-7/8" x 5-1/2" x 5"	12	10 lbs
QUS232CL	5-3/8" x 11" x 3"	8	5 lbs
QUS234CL	14-3/4" x 5-1/2" x 5"	12	14 lbs
QUS235CL	10-7/8" x 11" x 5"	6	10 lbs
QUS236CL	7-3/8" x 11" x 3"	8	9 lbs
QUS238CL	18" x 5-1/2" x 5"	12	16 lbs
QUS239CL	10-3/4" x 8-1/4" x 7"	6	10 lbs
QUS240CL	14-3/4" x 8-1/4" x 7"	12	24 lbs
QUS241CL	13-5/8" x 8-1/4" x 6"	12	22 lbs
QUS242CL	13-5/8" x 8-1/4" x 8"	12	25 lbs
QUS245CL	10-7/8" x 16-1/2" x 5"	6	13 lbs
QUS248CL	18" x 8-1/4" x 7"	6	19 lbs
QUS250CL	14-3/4" x 16-1/2" x 7"	6	21 lbs
QUS255CL	16" x 11" x 8"	4	14 lbs
QUS260CL	18" x 11" x 10"	4	17 lbs
QUS265CL	18" x 8-1/4" x 9"	6	17 lbs
QUS270CL	18" x 16-1/2" x 11"	3	16 lbs
QUS275MOBCL	18" x 16-1/2" x 11"	3	25 lbs

\*With casters, overall height is 14"

Clear-View Ultra Stack & Hang Bin Wire Shelving Systems - Complete Packages

Bins available in:  Clear  Up to 800 lb. LOAD CAPACITY PER SHELF

MODEL NO.	NO. OF SHELVES	NO. OF BINS	BIN DIMENSIONS L" x W" x H"	SHIP WGT
<b>12"W x 36"L x 74"H - Systems</b>				
WR8-239CL	8	28 QUS239CL	10-3/4" x 8-1/4" x 7"	103 lbs
WR7-245CL	7	24 QUS245CL	10-7/8" x 16-1/2" x 5"	111 lbs
<b>14"W x 36"L x 74"H - Systems</b>				
WR10-230240CL	10	36 QUS230CL 12 QUS240CL	10-7/8" x 5-1/2" x 5" 14-3/4" x 8-1/4" x 7"	146 lbs
WR8-240CL	8	28 QUS240CL	14-3/4" x 8-1/4" x 7"	128 lbs
WR8-250CL	8	14 QUS250CL	14-3/4" x 16-1/2" x 7"	129 lbs
<b>18"W x 36"L x 74"H - Systems</b>				
WR8-255CL	8	21 QUS255CL	16" x 11" x 8"	152 lbs
WR6-260CL	6	15 QUS260CL	18" x 11" x 10"	127 lbs
WR6-265CL	6	20 QUS265CL	18" x 8-1/4" x 9"	124 lbs
WR5-270CL	5	8 QUS270CL	18" x 16-1/2" x 11"	104 lbs

Clear-View Ultra Stack & Hang Bin Steel Shelving Systems - Complete Packages

Bins available in:  Clear  Up to 400 lb. LOAD CAPACITY PER SHELF

MODEL NO.	NO. OF SHELVES	NO. OF BINS	BIN DIMENSIONS L" x W" x H"	SHIP WGT
<b>12"D x 36"W x 75"H - Systems</b>				
QSBU-239CL	8	28 QUS239CL	10-3/4" x 8-1/4" x 7"	99 lbs
QSBU-230240CL	10	36 QUS230CL 12 QUS240CL	10-7/8" x 5-1/2" x 5" 14-3/4" x 8-1/4" x 7"	122 lbs
QSBU-240CL	8	28 QUS240CL	14-3/4" x 8-1/4" x 7"	110 lbs
QSBU-245CL	7	24 QUS245CL	10-7/8" x 16-1/2" x 5"	111 lbs
QSBU-250CL	8	14 QUS250CL	14-3/4" x 16-1/2" x 7"	99 lbs
<b>18"D x 36"W x 75"H - Systems</b>				
QSBU-255CL	8	21 QUS255CL	16" x 11" x 8"	140 lbs
QSBU-260CL	6	15 QUS260CL	18" x 11" x 10"	120 lbs
QSBU-265CL	7	24 QUS265CL	18" x 8-1/4" x 9"	134 lbs
QSBU-270CL	6	10 QUS270CL	18" x 16-1/2" x 11"	117 lbs



**QLP-1819-230-9CL**



**QBR-2721-220-24CL**



**Clear-View 12" Plastic Rail Systems - Complete Packages**

Comes with 2 handy 12" Plastic Rails ideal for mounting to any surface. Bins can hang or stack securely providing an efficient bin storage system. Available in Clear. Rails available in White. Mounting hardware is not included.

MODEL NO.	BIN DIMENSIONS L" x W" x H"	DESCRIPTION	SHIP WGT
<b>HNS210CL</b>	5-3/8" x 4-1/8" x 3"	6 bins + 2 rails	2 lbs
<b>HNS220CL</b>	7-3/8" x 4-1/8" x 3"	6 bins + 2 rails	3 lbs
<b>HNS230CL</b>	10-7/8" x 5-1/2" x 5"	4 bins + 2 rails	5 lbs
<b>HNS006</b>	Extra Rails	2 rails	1 lb

**HNS230CL**



**COMPLETE PACKAGES WITH BINS**



**QMD-36H-240CL**



**QRU-12D-220-192CL + QRU-MOB**  
Double Sided Rack, 12 Rails with Mobile Kit  
Up to 1,000 lb. capacity. 2 rigid, 1 swivel and 1 swivel with brake hard rubber casters. Accepts 12 sizes of Ultra Bins (up to 192 bins).

**Clear-View Bench Racks & Louvered Panel Systems - Complete Packages**

**Bench Racks:** 27-3/4" L x 8" W x 21" H and 36" L x 8" W x 19" H. Both Bench Racks are available in 3 pre-configured choices. Bench Racks can be joined together to form continuous systems.

**Louvered Panels:** 18" L x 19" H, 36" L x 19" H, 36" L x 61" H and 48" L x 61" H panels are available in 3 configurations. Louvered Panels are available in Gray or Oyster White color. To order an Oyster White Louvered Panel add **HC** to the model number (i.e. **QLP-1819HC-210-18CL**). Mounting hardware is not included.

Bins available in:  Clear

MODEL NO.	NO. OF BINS	BIN DIMENSIONS L" x W" x H"	SHIP WGT
<b>27-3/4" L x 8" W x 21" H - Bench Rack Systems</b>			
<b>QBR-2721-210-24CL</b>	24 QUS210CL	5-3/8" x 4-1/8" x 3"	23 lbs
<b>QBR-2721-220-24CL</b>	24 QUS220CL	7-3/8" x 4-1/8" x 3"	25 lbs
<b>QBR-2721-230-12CL</b>	12 QUS230CL	10-7/8" x 5-1/2" x 5"	28 lbs
<b>36" L x 8" W x 19" H - Bench Rack Systems</b>			
<b>QBR-3619-210-32CL</b>	32 QUS210CL	5-3/8" x 4-1/8" x 3"	29 lbs
<b>QBR-3619-220-32CL</b>	32 QUS220CL	7-3/8" x 4-1/8" x 3"	31 lbs
<b>QBR-3619-230-18CL</b>	18 QUS230CL	10-7/8" x 5-1/2" x 5"	37 lbs
<b>18" L x 19" H - Louvered Panel Systems</b>			
<b>QLP-1819-210-16CL</b>	16 QUS210CL	5-3/8" x 4-1/8" x 3"	11 lbs
<b>QLP-1819-220-16CL</b>	16 QUS220CL	7-3/8" x 4-1/8" x 3"	12 lbs
<b>QLP-1819-230-9CL</b>	9 QUS230CL	10-7/8" x 5-1/2" x 5"	16 lbs
<b>36" L x 19" H - Louvered Panel Systems</b>			
<b>QLP-3619-210-32CL</b>	32 QUS210CL	5-3/8" x 4-1/8" x 3"	22 lbs
<b>QLP-3619-220-32CL</b>	32 QUS220CL	7-3/8" x 4-1/8" x 3"	24 lbs
<b>QLP-3619-230-18CL</b>	18 QUS230CL	10-7/8" x 5-1/2" x 5"	30 lbs
<b>36" L x 61" H - Louvered Panel Systems</b>			
<b>QLP-3661-220-120CL</b>	120 QUS220CL	7-3/8" x 4-1/8" x 3"	80 lbs
<b>QLP-3661-230-60CL</b>	60 QUS230CL	10-7/8" x 5-1/2" x 5"	90 lbs
<b>QLP-3661-240-28CL</b>	28 QUS240CL	14-3/4" x 8-1/4" x 7"	96 lbs
<b>48" L x 61" H - Louvered Panel Systems</b>			
<b>QLP-4861-220-165CL</b>	165 QUS220CL	7-3/8" x 4-1/8" x 3"	115 lbs
<b>QLP-4861-230-80CL</b>	80 QUS230CL	10-7/8" x 5-1/2" x 5"	127 lbs
<b>QLP-4861-240-35CL</b>	35 QUS240CL	14-3/4" x 8-1/4" x 7"	130 lbs

**Clear-View Rail Systems - Complete Packages**

Bins available in:  Clear

MODEL NO.	NO. OF BINS	BIN DIMENSIONS L" x W" x H"	SHIP WGT
<b>36" L x 15" W x 53" H - Single Sided Rail Systems</b>			
<b>QRU-12S-220-96CL</b>	96 QUS220CL	7-3/8" x 4-1/8" x 3"	82 lbs
<b>QRU-16S-230-48CL</b>	48 QUS230CL	10-7/8" x 5-1/2" x 5"	108 lbs
<b>QRU-12S-240-24CL</b>	24 QUS240CL	14-3/4" x 8-1/4" x 7"	102 lbs
	16 QUS220CL	7-3/8" x 4-1/8" x 3"	
<b>QRU-16S-220230240CL</b>	18 QUS230CL	10-7/8" x 5-1/2" x 5"	108 lbs
	12 QUS240CL	14-3/4" x 8-1/4" x 7"	
<b>36" L x 20" W x 53" H - Double Sided Rail Systems</b>			
<b>QRU-12D-220-192CL</b>	192 QUS220CL	7-3/8" x 4-1/8" x 3"	113 lbs
<b>QRU-16D-230-96CL</b>	96 QUS230CL	10-7/8" x 5-1/2" x 5"	155 lbs
<b>QRU-12D-240-48CL</b>	48 QUS240CL	14-3/4" x 8-1/4" x 7"	153 lbs
<b>QRU-MOB</b>	Mobile Kit - Mobilizes Double Sided Systems		25 lbs

**Clear-View Mobile Double Sided Louvered Rack Systems - Complete Packages**

Bins available in:  Clear

MODEL NO.	NO. OF BINS	BIN DIMENSIONS L" x W" x H"	SHIP WGT
<b>36" L x 25" W x 72" H - Mobile Unit Up To 1,200 lb. Capacity</b>			
<b>QMD-36H-220CL</b>	240 QUS220CL	7-3/8" x 4-1/8" x 3"	174 lbs
<b>QMD-36H-230CL</b>	120 QUS230CL	10-7/8" x 5-1/2" x 5"	212 lbs
<b>QMD-36H-240CL</b>	56 QUS240CL	14-3/4" x 8-1/4" x 7"	208 lbs
	72 QUS230CL	10-7/8" x 5-1/2" x 5"	
<b>QMD-36H-230240CL</b>	24 QUS240CL	14-3/4" x 8-1/4" x 7"	217 lbs

Clear-View HULK 24" Containers



Organize and store your large and bulky items with these strong injection molded tri-clear virgin-grade polypropylene, stackable containers. These extra large stacking containers offer a generous 2 feet in length to store your larger items. Heavy-duty front, back and side grips allow for easy handling. Clear window fronts and dividers available on **pg. 36**. Wide stacking ledge and anti-slide lock keep stacked bins steady and prevent forward shifting. Waterproof bins resist rust and corrosion. Bins are autoclavable up to 250°F and are resistant to extreme cold.

Available in:  Clear

MODEL NO.	OUTSIDE DIMENSIONS L" x W" x H"	CTN QTY	CTN WGT
QUS950CL	23-7/8" x 8-1/4" x 7"	6	18 lbs
QUS951CL	23-7/8" x 8-1/4" x 9"	6	21 lbs
QUS952CL	23-7/8" x 11" x 7"	4	14 lbs
QUS953CL	23-7/8" x 11" x 10"	4	18 lbs
QUS954CL	23-7/8" x 16-1/2" x 11"	1	7 lbs
QUS964MOBCL	23-7/8" x 16-1/2" x 11"	1	9 lbs
QUS955CL	23-7/8" x 18-1/4" x 12"	1	8 lbs
QUS965MOBCL	23-7/8" x 18-1/4" x 12"	1	10 lbs
QUS957CL	23-7/8" x 22-1/2" x 12"	1	8 lbs
QUS967MOBCL	23-7/8" x 22-1/2" x 12"	1	10 lbs

\*With casters, overall height for mobile container will be increased by 3"

QUANTUM IS CLEARLY YOUR STORAGE SOLUTION

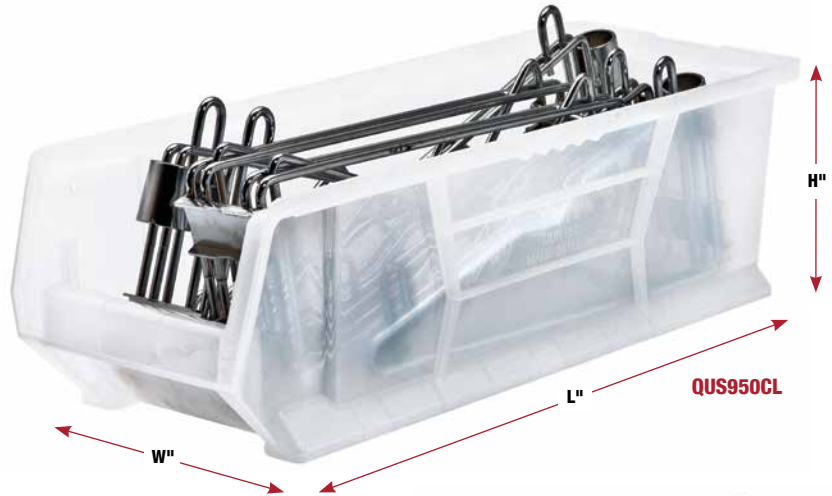

Clear-View HULK 24" Container Wire Shelving Systems - Complete Packages

Bins available in:  Clear **Up to 800 lb. LOAD CAPACITY PER SHELF**

MODEL NO.	NO. OF SHELVES	NO. OF BINS	BIN DIMENSIONS L" x W" x H"	SHIP WGT
<b>24"W x 36"L x 74"H - Systems</b>				
WR8-950CL	8	28 QUS950CL	23-7/8" x 8-1/4" x 7"	205 lbs
WR8-950952CL	8	12 QUS950CL	23-7/8" x 8-1/4" x 7"	197 lbs
		12 QUS952CL	23-7/8" x 11" x 7"	
WR8-952CL	8	21 QUS952CL	23-7/8" x 11" x 7"	191 lbs
WR7-951CL	7	24 QUS951CL	23-7/8" x 8-1/4" x 9"	188 lbs
		8 QUS950CL	23-7/8" x 8-1/4" x 7"	
WR7-20-MIXCL	7	4 QUS951CL	23-7/8" x 8-1/4" x 9"	182 lbs
		3 QUS952CL	23-7/8" x 11" x 7"	
		3 QUS953CL	23-7/8" x 11" x 10"	
		2 QUS954CL	23-7/8" x 16-1/2" x 11"	
		15 QUS953CL	23-7/8" x 11" x 10"	
WR6-953CL	6	9 QUS953CL	23-7/8" x 11" x 10"	156 lbs
		4 QUS954CL	23-7/8" x 16-1/2" x 11"	
WR6-953954CL	6	9 QUS953CL	23-7/8" x 11" x 10"	159 lbs
		4 QUS954CL	23-7/8" x 16-1/2" x 11"	
WR6-954CL	6	10 QUS954CL	23-7/8" x 16-1/2" x 11"	164 lbs
<b>24"W x 42"L x 74"H - System</b>				
WR5-955CL	5	8 QUS955CL	23-7/8" x 18-1/4" x 12"	145 lbs
<b>24"W x 48"L x 74"H - System</b>				
WR6-957CL	6	10 QUS957CL	23-7/8" x 22-1/2" x 12"	192 lbs



COMPLETE PACKAGES WITH BINS



Clear-View HULK 24" Container Steel Shelving Systems - Complete Packages

Bins available in:  Clear **Up to 400 lb. LOAD CAPACITY PER SHELF**

MODEL NO.	NO. OF SHELVES	NO. OF BINS	BIN DIMENSIONS L" x W" x H"	SHIP WGT
<b>24"D x 36"W x 75"H - Systems</b>				
2475-950CL	8	28 QUS950CL	23-7/8" x 8-1/4" x 7"	213 lbs
2475-950952CL	8	12 QUS950CL	23-7/8" x 8-1/4" x 7"	195 lbs
		12 QUS952CL	23-7/8" x 11" x 7"	
2475-952CL	8	21 QUS952CL	23-7/8" x 11" x 7"	205 lbs
2475-951CL	7	24 QUS951CL	23-7/8" x 8-1/4" x 9"	199 lbs
		8 QUS950CL	23-7/8" x 8-1/4" x 7"	
2475-20-MIXCL	7	4 QUS951CL	23-7/8" x 8-1/4" x 9"	189 lbs
		3 QUS952CL	23-7/8" x 11" x 7"	
		3 QUS953CL	23-7/8" x 11" x 10"	
		2 QUS954CL	23-7/8" x 16-1/2" x 11"	
		15 QUS953CL	23-7/8" x 11" x 10"	
2475-953CL	6	9 QUS953CL	23-7/8" x 11" x 10"	163 lbs
		4 QUS954CL	23-7/8" x 16-1/2" x 11"	
2475-953954CL	6	9 QUS953CL	23-7/8" x 11" x 10"	166 lbs
		4 QUS954CL	23-7/8" x 16-1/2" x 11"	
2475-954CL	6	10 QUS954CL	23-7/8" x 16-1/2" x 11"	171 lbs



MOBILIZE YOUR WIRE SHELVING

**DB - Donut Bumper**  
Non-marking donut bumper used to protect walls and help cushion impact.

**WR-00H (Mobile Kit)**  
Set of four swivel thermoplastic resin 5" x 1-1/4" casters, two with brakes. Can be used with all systems shown. Up to 1,200 lb. load capacity.



**LOWEST PRICE GUARANTEE**



**QGH700CL**



**QGH705MOBCL**

## COMPLETE PACKAGES WITH BINS



**WR5-600CL**



## QUANTUM IS CLEARLY YOUR STORAGE SOLUTION



**QSBU-700CL**



### MOBILIZE YOUR WIRE SHELVING

**DB - Donut Bumper**  
Non-marking donut bumper used to protect walls and help cushion impact.

**WR-00H (Mobile Kit)**  
Set of four swivel thermoplastic resin 5" x 1-1/4" casters, two with brakes. Can be used with all systems shown. Up to 1,200 lb. load capacity.



### Clear-View Giant Stack Containers

Multipurpose, wide open hopper front provides easy access for large part storage. Ideal for multiple applications in recycling, storing parts, tools and warehouse items. This bin will stack up to 6 bins high creating a sturdy, tall storage system. Injection molded from high density tri-clear virgin-grade polypropylene, easy to clean, resists rust and corrosion and impervious to most chemicals. Large label holder allows for quick identification. Optional clear window front increases storage capacity and allows for inspection of parts. Six 1/4" drill hole pattern on bottom of bin allows for easy hole insertion for drainage.

Available in:  Clear

MODEL NO.	OUTSIDE DIMENSIONS L" x W" x H"	CTN QTY	CTN WGT	WINDOW	CTN WGT
<b>QGH600CL</b>	17-1/2" x 10-7/8" x 12-1/2"	4	12 lbs	<b>WGH600</b>	4
<b>QGH700CL*</b>	15-1/4" x 19-7/8" x 12-7/16"	3	13 lbs	<b>WGH700</b>	3
<b>QGH800CL*</b>	17-1/2" x 16-1/2" x 12-1/2"	2	8 lbs	<b>WGH800</b>	2

\*With casters, overall height for mobile container will be increased by 3"

### Clear-View Mobile Giant Stack Containers



- Ideal for transport of heavy and bulky parts
- Container comes with 4 swivel, 3" polyurethane casters, all with brakes, allowing for up to 250 lb. mobile load capacity
- Containers can stack with casters in place

Available in:  Clear

MODEL NO.	OUTSIDE DIMENSIONS L" x W" x H"	CTN QTY	CTN WGT	WINDOW	CTN WGT
<b>QGH705MOBCL*</b>	15-1/4" x 19-7/8" x 12-7/16"	3	22 lbs	<b>WGH700</b>	3
<b>QGH805MOBCL*</b>	17-1/2" x 16-1/2" x 12-1/2"	2	17 lbs	<b>WGH800</b>	2

\*With casters, overall height for mobile container will be increased by 3"

### Clear-View Giant Stack Wire Shelving Systems - Complete Packages

Bins available in:  Clear **Up to 800 lb. LOAD CAPACITY PER SHELF**

MODEL NO.	NO. OF BINS	BIN DIMENSIONS L" x W" x H"	SHIP WGT
<b>18"W x 36"L x 74"H - 5 Shelf Systems</b>			
<b>WR5-600CL</b>	12 QGH600CL	17-1/2" x 10-7/8" x 12-1/2"	104 lbs
<b>WR5-600800CL</b>	6 QGH600CL 4 QGH800CL	17-1/2" x 10-7/8" x 12-1/2" 17-1/2" x 16-1/2" x 12-1/2"	103 lbs
<b>WR5-800CL</b>	8 QGH800CL	17-1/2" x 16-1/2" x 12-1/2"	102 lbs
<b>18"W x 42"L x 74"H - 5 Shelf System</b>			
<b>WR5-700CL</b>	8 QGH700CL	15-1/4" x 19-7/8" x 12-7/16"	98 lbs

### Clear-View Giant Stack Steel Shelving Systems - Complete Packages

Smooth powder coat finish and cross bracing for increased stability. Up to 400 lb. capacity per shelf and over 21 cubic feet of storage space.

Bins available in:  Clear **Up to 400 lb. LOAD CAPACITY PER SHELF**

MODEL NO.	NO. OF BINS	BIN DIMENSIONS L" x W" x H"	SHIP WGT
<b>18"W x 36"L x 75"H - 6 Shelf Systems</b>			
<b>QSBU-600CL</b>	12 QGH600CL	17-1/2" x 10-7/8" x 12-1/2"	116 lbs
<b>QSBU-600800CL</b>	6 QGH600CL 6 QGH800CL	17-1/2" x 10-7/8" x 12-1/2" 17-1/2" x 16-1/2" x 12-1/2"	114 lbs
<b>QSBU-800CL</b>	10 QGH800CL	17-1/2" x 16-1/2" x 12-1/2"	113 lbs
<b>18"W x 42"L x 75"H - 6 Shelf System</b>			
<b>QSBU-700CL</b>	10 QGH700CL	15-1/4" x 19-7/8" x 12-7/16"	123 lbs

Clear-View Economy 4" Shelf Bins



Quantum's tough, durable, high density Economy 4" Shelf Bins are the industry standard for quality. These tri-clear virgin-grade polypropylene bins feature a molded-in label holder, built-in rear hanglock which allows bins to tilt out for complete access when on shelving. A wide hopper front allows complete access to the contents of the bin. Edges are reinforced for added strength. They are designed for 12", 18" and 24" deep shelf units, racks or standard shelving. Bins are impervious to most chemicals. Dividers, bin cups and label holders available on *pg. 50*.



QSB106CL



MOBILIZE YOUR WIRE SHELVING

DB - Donut Bumper

Non-marking donut bumper used to protect walls and help cushion impact.

WR-00H (Mobile Kit)\*

Set of four swivel thermoplastic resin 5" x 1-1/4" casters, two with brakes. Up to 1,200 lb. load capacity.

\*Mobile kits recommended only for shelves 18" and deeper.

QUANTUM IS CLEARLY YOUR STORAGE SOLUTION



WR12-107CL

COMPLETE PACKAGES WITH BINS



WR6-36-1236-109CL

Available in: ● Clear

MODEL NO.	OUTSIDE DIMENSIONS L" x W" x H"	CTN QTY	CTN WGT
QSB100CL	11-5/8" x 2-3/4" x 4"	36	13 lbs
QSB101CL	11-5/8" x 4-1/8" x 4"	36	17 lbs
QSB102CL	11-5/8" x 6-5/8" x 4"	30	18 lbs
QSB107CL	11-5/8" x 8-3/8" x 4"	20	15 lbs
QSB109CL	11-5/8" x 11-1/8" x 4"	8	7 lbs
QSB103CL	17-7/8" x 4-1/8" x 4"	20	13 lbs
QSB118CL <b>NEW</b>	11-5/8" x 16-1/2" x 4"	6	7 lbs
QSB104CL	17-7/8" x 6-5/8" x 4"	20	16 lbs
QSB108CL	17-7/8" x 8-3/8" x 4"	10	11 lbs
QSB110CL	17-7/8" x 11-1/8" x 4"	8	11 lbs
QSB122CL <b>NEW</b>	17-7/8" x 16-1/2" x 4"	6	10 lbs
QSB105CL	23-5/8" x 4-1/8" x 4"	16	13 lbs
QSB106CL	23-5/8" x 6-5/8" x 4"	8	9 lbs
QSB114CL	23-5/8" x 8-3/8" x 4"	6	9 lbs
QSB116CL	23-5/8" x 11-1/8" x 4"	6	10 lbs



Clear-View Complete Bin Center

Complete bin systems are available with 4 different size bin options on a 12"W x 36"L x 36"H unit. This all-purpose bin center is an economical high density storage system that provides superior visibility to stored contents.

Bins available in: ● Clear **Up to 800 lb. LOAD CAPACITY PER SHELF**

MODEL NO.	NO. OF BINS	BIN DIMENSIONS L" x W" x H"	SHIP WGT
<b>12"W x 36"L x 36"H - 6 Shelf Systems</b>			
WR6-36-1236-101CL	40 QSB101CL	11-5/8" x 4-1/8" x 4"	63 lbs
WR6-36-1236-102CL	25 QSB102CL	11-5/8" x 6-5/8" x 4"	50 lbs
WR6-36-1236-107CL	20 QSB107CL	11-5/8" x 8-3/8" x 4"	62 lbs
WR6-36-1236-109CL	15 QSB109CL	11-5/8" x 11-1/8" x 4"	64 lbs

Clear-View Economy 4" Shelf Bin Wire Shelving Systems - Complete Packages

Bins available in: ● Clear **Up to 800 lb. LOAD CAPACITY PER SHELF**

MODEL NO.	NO. OF BINS	BIN DIMENSIONS L" x W" x H"	SHIP WGT
<b>12"W x 36"L x 74"H - 12 Shelf Systems</b>			
WR12-101CL	88 QSB101CL	11-5/8" x 4-1/8" x 4"	120 lbs
WR12-102CL	55 QSB102CL	11-5/8" x 6-5/8" x 4"	116 lbs
WR12-107CL	44 QSB107CL	11-5/8" x 8-3/8" x 4"	117 lbs
WR12-109CL	33 QSB109CL	11-5/8" x 11-1/8" x 4"	119 lbs
<b>18"W x 36"L x 74"H - 12 Shelf Systems</b>			
WR12-103CL	88 QSB103CL	17-7/8" x 4-1/8" x 4"	176 lbs
WR12-104CL	55 QSB104CL	17-7/8" x 6-5/8" x 4"	165 lbs
WR12-108CL	44 QSB108CL	17-7/8" x 8-3/8" x 4"	170 lbs
WR12-110CL	33 QSB110CL	17-7/8" x 11-1/8" x 4"	168 lbs
<b>24"W x 36"L x 74"H - 12 Shelf Systems</b>			
WR12-105CL	88 QSB105CL	23-5/8" x 4-1/8" x 4"	228 lbs
WR12-106CL	55 QSB106CL	23-5/8" x 6-5/8" x 4"	218 lbs
WR12-114CL	44 QSB114CL	23-5/8" x 8-3/8" x 4"	222 lbs
WR12-116CL	33 QSB116CL	23-5/8" x 11-1/8" x 4"	206 lbs



**LOWEST PRICE GUARANTEE**



**QPRHA-100CL** Up to **350 lb.** LOAD CAPACITY

# SLOPED SHELVES EASY ACCESS

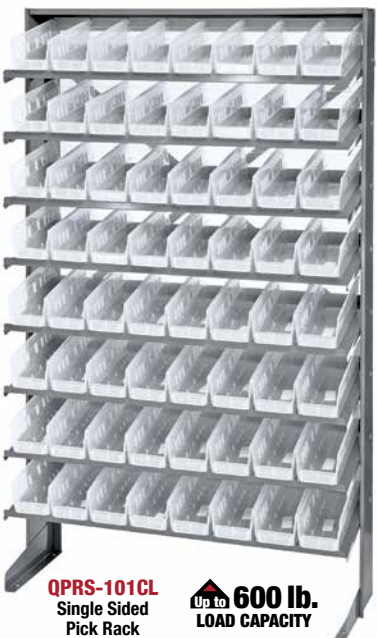

**QPRS-101CL** Single Sided Pick Rack Up to **600 lb.** LOAD CAPACITY



**QPRD-109CL** Double Sided Pick Rack Up to **1,600 lb.** LOAD CAPACITY

## Clear-View Economy 4" Shelf Bin Sloped Shelving Systems - Complete Packages

Pick Racks provide a convenient high density, easy access, sloped shelving system, available as bench units, single and double sided free standing and mobile units. Unit comes complete with Economical Shelf Bins. Sloped shelving unit keeps small and medium sized parts easily accessible. Open hopper front bins with label area, provide fast access to stored items. This all-in-one unit is easy to clean and will not rust or corrode. See chart for configurations. Bins available in Clear.

Bins available in:  Clear

MODEL NO.	NO. OF BINS	BIN DIMENSIONS L" x W" x H"	SHIP WGT
<b>12-1/2"L x 36"W x 23"H - 3 Shelf Bench Rack Systems</b>			
QPRHA-100CL	36 QSB100CL	11-5/8" x 2-3/4" x 4"	41 lbs
QPRHA-101CL	24 QSB101CL	11-5/8" x 4-1/8" x 4"	38 lbs
QPRHA-102CL	15 QSB102CL	11-5/8" x 6-5/8" x 4"	36 lbs
QPRHA-107CL	12 QSB107CL	11-5/8" x 8-3/8" x 4"	36 lbs
QPRHA-109CL	9 QSB109CL	11-5/8" x 11-1/8" x 4"	37 lbs
<b>12"L x 36"W x 60"H - Single Sided 8 Shelf Rack Systems</b>			
QPRS-100CL	96 QSB100CL	11-5/8" x 2-3/4" x 4"	99 lbs
QPRS-101CL	64 QSB101CL	11-5/8" x 4-1/8" x 4"	85 lbs
QPRS-102CL	40 QSB102CL	11-5/8" x 6-5/8" x 4"	80 lbs
QPRS-107CL	32 QSB107CL	11-5/8" x 8-3/8" x 4"	81 lbs
QPRS-109CL	24 QSB109CL	11-5/8" x 11-1/8" x 4"	83 lbs
<b>24"L x 36"W x 60"H - Double Sided 16 Shelf Rack Systems</b>			
QPRD-100CL	192 QSB100CL	11-5/8" x 2-3/4" x 4"	195 lbs
QPRD-101CL	128 QSB101CL	11-5/8" x 4-1/8" x 4"	169 lbs
QPRD-102CL	80 QSB102CL	11-5/8" x 6-5/8" x 4"	158 lbs
QPRD-107CL	64 QSB107CL	11-5/8" x 8-3/8" x 4"	160 lbs
QPRD-109CL	48 QSB109CL	11-5/8" x 11-1/8" x 4"	163 lbs
QDU-00*	Mobile Kit - Mobilizes All Double Sided Systems		25 lbs

\*Up to 1,200 lb. load capacity. 2 rigid, 2 swivel with brake hard rubber casters.

# QUANTUM IS CLEARLY YOUR STORAGE SOLUTION

## Clear-View Economy 4" Shelf Bin Steel Shelving Systems - Complete Packages

Bins available in:  Clear Up to **350 lb.** LOAD CAPACITY PER SHELF

MODEL NO.	NO. OF BINS	BIN DIMENSIONS L" x W" x H"	SHIP WGT
<b>12"D x 36"W x 75"H - 13 Shelf Systems</b>			
1275-100CL	144 QSB100CL	11-5/8" x 2-3/4" x 4"	139 lbs
1275-101CL	96 QSB101CL	11-5/8" x 4-1/8" x 4"	117 lbs
1275-102CL	60 QSB102CL	11-5/8" x 6-5/8" x 4"	115 lbs
1275-107CL	48 QSB107CL	11-5/8" x 8-3/8" x 4"	120 lbs
1275-109CL	36 QSB109CL	11-5/8" x 11-1/8" x 4"	119 lbs
<b>12"D x 36"W x 39"H - 7 Shelf Systems</b>			
1239-100CL	72 QSB100CL	11-5/8" x 2-3/4" x 4"	75 lbs
1239-101CL	48 QSB101CL	11-5/8" x 4-1/8" x 4"	67 lbs
1239-102CL	30 QSB102CL	11-5/8" x 6-5/8" x 4"	63 lbs
1239-107CL	24 QSB107CL	11-5/8" x 8-3/8" x 4"	64 lbs
1239-109CL	18 QSB109CL	11-5/8" x 11-1/8" x 4"	65 lbs
<b>18"D x 36"W x 75"H - 13 Shelf Systems</b>			
1875-103CL	96 QSB103CL	17-7/8" x 4-1/8" x 4"	161 lbs
1875-104CL	60 QSB104CL	17-7/8" x 6-5/8" x 4"	155 lbs
1875-108CL	48 QSB108CL	17-7/8" x 8-3/8" x 4"	161 lbs
1875-110CL	36 QSB110CL	17-7/8" x 11-1/8" x 4"	158 lbs
<b>18"D x 36"W x 39"H - 7 Shelf Systems</b>			
1839-103CL	48 QSB103CL	17-7/8" x 4-1/8" x 4"	87 lbs
1839-104CL	30 QSB104CL	17-7/8" x 6-5/8" x 4"	84 lbs
1839-108CL	24 QSB108CL	17-7/8" x 8-3/8" x 4"	87 lbs
1839-110CL	18 QSB110CL	17-7/8" x 11-1/8" x 4"	86 lbs

## COMPLETE PACKAGES WITH BINS



**1239-107CL**



**1275-102CL**

Clear-View STORE-MORE 6" Shelf Bins



Maximize your storage space with durable, high density tri-clear virgin-grade polypropylene bins. Quantum's STORE-MORE 6" Shelf Bins are the industry standard for quality. These bins feature a molded-in label holder, built-in rear hang-lock which allows bins to tilt out for complete access when on shelving. A wide hopper front allows complete access to the contents of the bin. Edges are reinforced for added strength. They are designed for 12", 18" and 24" deep shelf units, racks or standard shelving. Optional dividers are a perfect solution to create a par level system. Bins are waterproof and corrosion-free. Dividers, bin cups and label holders available on pg. 55.



MOBILIZE YOUR WIRE SHELVING

DB - Donut Bumper

Non-marking donut bumper used to protect walls and help cushion impact.

WR-00H (Mobile Kit)\*

Set of four swivel thermoplastic resin 5" x 1-1/4" casters, two with brakes. Up to 1,200 lb. load capacity.

\*Mobile kits recommended only for shelves 18" and deeper.

COMPLETE PACKAGES WITH BINS

QUANTUM IS CLEARLY YOUR STORAGE SOLUTION



WR5-39-1236-209CL



WR9-202CL

Available in:  Clear

MODEL NO.	OUTSIDE DIMENSIONS L" x W" x H"	CTN QTY	CTN WGT
QSB201CL	11-5/8" x 4-1/8" x 6"	36	19 lbs
QSB202CL	11-5/8" x 6-5/8" x 6"	30	20 lbs
QSB207CL	11-5/8" x 8-3/8" x 6"	20	17 lbs
QSB209CL	11-5/8" x 11-1/8" x 6"	8	9 lbs
QSB209CL	11-5/8" x 11-1/8" x 6"	8	9 lbs
QSB218CL <b>NEW</b>	11-5/8" x 16-1/2" x 6"	6	8 lbs
QSB204CL	17-7/8" x 6-5/8" x 6"	20	18 lbs
QSB208CL	17-7/8" x 8-3/8" x 6"	10	13 lbs
QSB210CL	17-7/8" x 11-1/8" x 6"	8	13 lbs
QSB222CL <b>NEW</b>	17-7/8" x 16-1/2" x 6"	6	12 lbs
QSB205CL	23-5/8" x 4-1/8" x 6"	16	15 lbs
QSB206CL	23-5/8" x 6-5/8" x 6"	8	11 lbs
QSB214CL	23-5/8" x 8-3/8" x 6"	6	11 lbs
QSB216CL	23-5/8" x 11-1/8" x 6"	6	12 lbs

68% more storage capacity over standard 4" shelf bins, Quantum's STORE-MORE 6" Shelf Bins were an industry first and now an industry leader.



Clear-View Complete Bin Center

Complete bin systems are available with 4 different size bins on a 12"W x 36"L x 39"H unit. This all-purpose bin center is an economical high density storage system that provides easy visibility to stored contents.

Bins available in:  Clear **Up to 800 lb. LOAD CAPACITY PER SHELF**

MODEL NO.	NO. OF BINS	BIN DIMENSIONS L" x W" x H"	SHIP WGT
<b>12"W x 36"L x 39"H - 5 Shelf Systems</b>			
WR5-39-1236-201CL	32 QSB201CL	11-5/8" x 4-1/8" x 6"	61 lbs
WR5-39-1236-202CL	20 QSB202CL	11-5/8" x 6-5/8" x 6"	57 lbs
WR5-39-1236-207CL	16 QSB207CL	11-5/8" x 8-3/8" x 6"	56 lbs
WR5-39-1236-209CL	12 QSB209CL	11-5/8" x 11-1/8" x 6"	55 lbs

Clear-View STORE-MORE 6" Shelf Bin Wire Shelving Systems - Complete Packages

Bins available in:  Clear **Up to 800 lb. LOAD CAPACITY PER SHELF**

MODEL NO.	NO. OF BINS	BIN DIMENSIONS L" x W" x H"	SHIP WGT
<b>12"W x 36"L x 74"H - 9 Shelf Systems</b>			
WR9-201CL	64 QSB201CL	11-5/8" x 4-1/8" x 6"	108 lbs
WR9-202CL	40 QSB202CL	11-5/8" x 6-5/8" x 6"	100 lbs
WR9-207CL	32 QSB207CL	11-5/8" x 8-3/8" x 6"	98 lbs
WR9-209CL	24 QSB209CL	11-5/8" x 11-1/8" x 6"	96 lbs
<b>18"W x 36"L x 74"H - 9 Shelf Systems</b>			
WR9-203CL	64 QSB203CL	17-7/8" x 4-1/8" x 6"	156 lbs
WR9-204CL	40 QSB204CL	17-7/8" x 6-5/8" x 6"	142 lbs
WR9-208CL	32 QSB208CL	17-7/8" x 8-3/8" x 6"	143 lbs
WR9-210CL	24 QSB210CL	17-7/8" x 11-1/8" x 6"	140 lbs
<b>24"W x 36"L x 74"H - 9 Shelf Systems</b>			
WR9-205CL	64 QSB205CL	23-5/8" x 4-1/8" x 6"	182 lbs
WR9-206CL	40 QSB206CL	23-5/8" x 6-5/8" x 6"	171 lbs
WR9-214CL	32 QSB214CL	23-5/8" x 8-3/8" x 6"	165 lbs
WR9-216CL	24 QSB216CL	23-5/8" x 11-1/8" x 6"	154 lbs



**QPRHA-201CL** **350 lb.**  
LOAD CAPACITY

## SLOPED SHELVES EASY ACCESS



**QPRD-209CL**  
Double Sided  
Pick Rack **1,600 lb.**  
LOAD CAPACITY

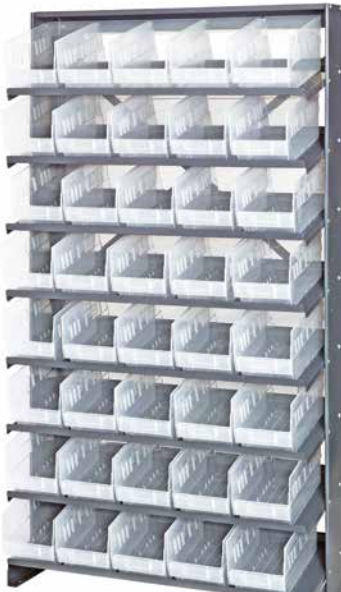

**QPRS-202CL**  
Single Sided  
Pick Rack **600 lb.**  
LOAD CAPACITY

### Clear-View STORE-MORE 6" Shelf Bin Sloped Steel Shelving Systems - Complete Packages

Pick Racks provide a convenient high density, easy access, sloped shelving system, available as bench units, single and double sided free standing and mobile units. Unit comes complete with STORE-MORE 6" Shelf Bins. Sloped shelving unit keeps small and medium sized parts easily accessible. Open hopper front bins with label area, provide fast access to stored items. This all-in-one unit is easy to clean and will not rust or corrode. See chart for configurations. Bins available in Clear.

Bins available in:  Clear

MODEL NO.	NO. OF BINS	BIN DIMENSIONS L" x W" x H"	SHIP WGT
<b>12"L x 36"W x 26-1/2"H - 3 Shelf Bench Rack Systems</b>			
<b>QPRHA-201CL</b>	24 QSB201CL	11-5/8" x 4-1/8" x 6"	40 lbs
<b>QPRHA-202CL</b>	15 QSB202CL	11-5/8" x 6-5/8" x 6"	37 lbs
<b>QPRHA-207CL</b>	12 QSB207CL	11-5/8" x 8-3/8" x 6"	36 lbs
<b>QPRHA-209CL</b>	9 QSB209CL	11-5/8" x 11-1/8" x 6"	35 lbs
<b>12"L x 36"W x 63-1/2"H - Single Sided 8 Shelf Rack Systems</b>			
<b>QPRS-201CL</b>	64 QSB201CL	11-5/8" x 4-1/8" x 6"	89 lbs
<b>QPRS-202CL</b>	40 QSB202CL	11-5/8" x 6-5/8" x 6"	81 lbs
<b>QPRS-207CL</b>	32 QSB207CL	11-5/8" x 8-3/8" x 6"	79 lbs
<b>QPRS-209CL</b>	24 QSB209CL	11-5/8" x 11-1/8" x 6"	77 lbs
<b>24"L x 36"W x 63-1/2"H - Double Sided 16 Shelf Rack Systems</b>			
<b>QPRD-201CL</b>	128 QSB201CL	11-5/8" x 4-1/8" x 6"	178 lbs
<b>QPRD-202CL</b>	80 QSB202CL	11-5/8" x 6-5/8" x 6"	162 lbs
<b>QPRD-207CL</b>	64 QSB207CL	11-5/8" x 8-3/8" x 6"	158 lbs
<b>QPRD-209CL</b>	48 QSB209CL	11-5/8" x 11-1/8" x 6"	154 lbs
<b>QDU-00*</b>	Mobile Kit - Mobilizes All Double Sided Systems		25 lbs

\*Up to 1,200 lb. load capacity. 2 rigid, 2 swivel with brake hard rubber casters.

## COMPLETE PACKAGES WITH BINS

### Clear-View STORE-MORE 6" Shelf Bin Steel Shelving Systems - Complete Packages

Bins available in:  Clear **400 lb.** LOAD CAPACITY PER SHELF

MODEL NO.	NO. OF BINS	BIN DIMENSIONS L" x W" x H"	SHIP WGT
<b>12"D x 36"W x 75"H - 10 Shelf Systems</b>			
<b>1275-201CL</b>	72 QSB201CL	11-5/8" x 4-1/8" x 6"	111 lbs
<b>1275-202CL</b>	45 QSB202CL	11-5/8" x 6-5/8" x 6"	103 lbs
<b>1275-207CL</b>	36 QSB207CL	11-5/8" x 8-3/8" x 6"	100 lbs
<b>1275-209CL</b>	27 QSB209CL	11-5/8" x 11-1/8" x 6"	98 lbs
<b>12"D x 36"W x 39"H - 5 Shelf Systems</b>			
<b>1239-201CL</b>	32 QSB201CL	11-5/8" x 4-1/8" x 6"	56 lbs
<b>1239-202CL</b>	20 QSB202CL	11-5/8" x 6-5/8" x 6"	52 lbs
<b>1239-207CL</b>	16 QSB207CL	11-5/8" x 8-3/8" x 6"	51 lbs
<b>1239-209CL</b>	12 QSB209CL	11-5/8" x 11-1/8" x 6"	50 lbs
<b>18"D x 36"W x 75"H - 10 Shelf Systems</b>			
<b>1875-203CL</b>	72 QSB203CL	17-7/8" x 4-1/8" x 6"	156 lbs
<b>1875-204CL</b>	45 QSB204CL	17-7/8" x 6-5/8" x 6"	141 lbs
<b>1875-208CL</b>	36 QSB208CL	17-7/8" x 8-3/8" x 6"	142 lbs
<b>1875-210CL</b>	27 QSB210CL	17-7/8" x 11-1/8" x 6"	139 lbs
<b>18"D x 36"W x 39"H - 5 Shelf Systems</b>			
<b>1839-203CL</b>	32 QSB203CL	17-7/8" x 4-1/8" x 6"	77 lbs
<b>1839-204CL</b>	20 QSB204CL	17-7/8" x 6-5/8" x 6"	70 lbs
<b>1839-208CL</b>	16 QSB208CL	17-7/8" x 8-3/8" x 6"	71 lbs
<b>1839-210CL</b>	12 QSB210CL	17-7/8" x 11-1/8" x 6"	69 lbs

## QUANTUM IS CLEARLY YOUR STORAGE SOLUTION



**1239-201CL**



**1275-202CL**

# QUANTUM IS CLEARLY YOUR STORAGE SOLUTION

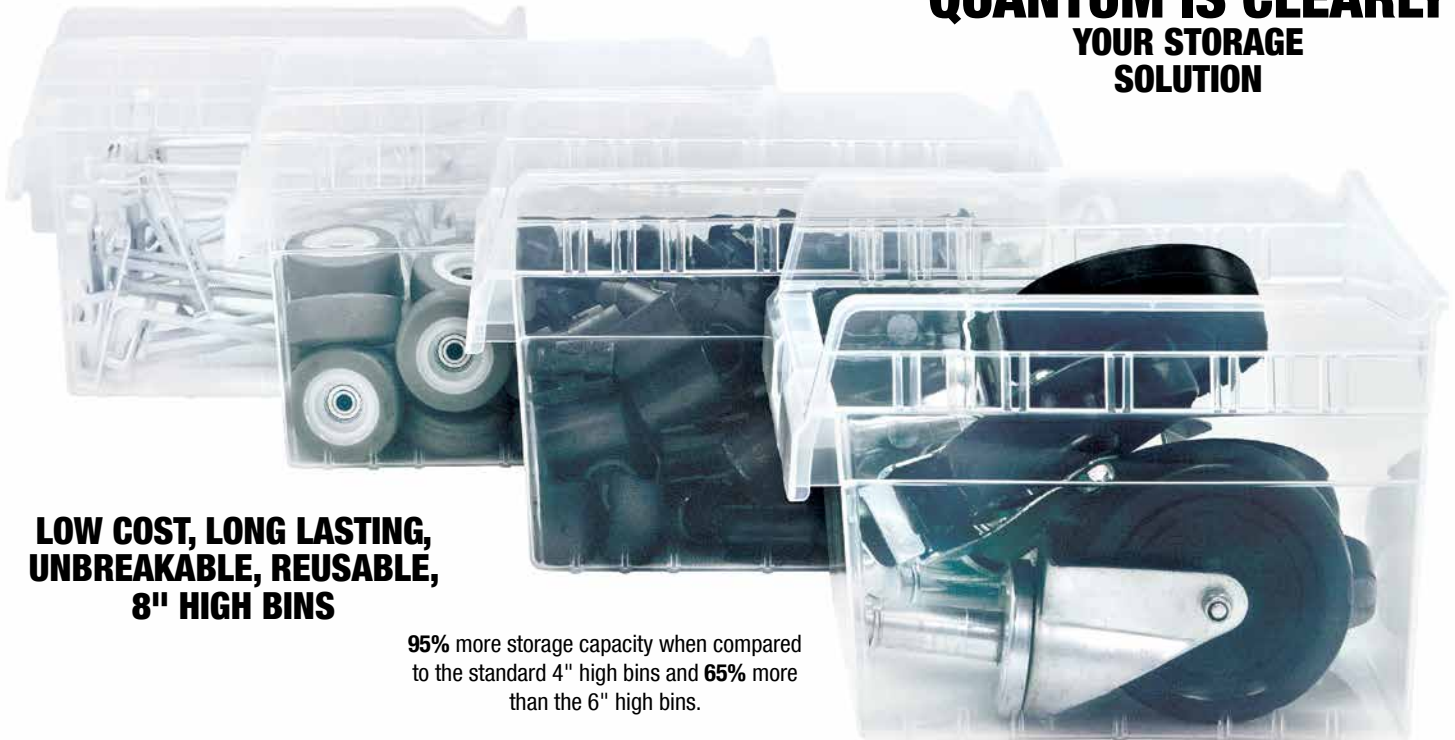

**LOW COST, LONG LASTING,  
UNBREAKABLE, REUSABLE,  
8" HIGH BINS**

95% more storage capacity when compared to the standard 4" high bins and 65% more than the 6" high bins.



**LTR-1253**  
**Clear Label Holder**  
Clear label holders and laser label inserts. Clear label holders fit all 8" Shelf Bins. Package of 25.



DLT-6

### Divider Label Tab

Divider Label Tabs attach to existing dividers to improve the visibility of bin labels and scanning of barcodes. Package of 6.

### Clear-View STORE-MAX 8" Shelf Bins



Our new 8" high bins offer 95% more storage capacity when compared to the standard 4" high bins and 65% more than the 6" high bins. The new STORE-MAX 8" bins will truly maximize and organize your space. Manufactured from high density tri-clear virgin-grade polypropylene, STORE-MAX 8" Shelf Bins are the industry standard for quality. These bins feature a molded-in label holder on a wide hopper front allowing complete access to the contents of the bin. Edges are reinforced for added strength. They are designed for 12", 18" and 24" deep shelf units, racks or standard shelving. Optional dividers are a perfect accessory to subdivide and keep parts separated as needed.

Available in: ● Clear

MODEL NO.	OUTSIDE DIMENSIONS L" x W" x H"	INSIDE DIMENSIONS L" x W" x H"	CTN QTY	CTN WGT	DIVIDER	CTN QTY	NO. OF BIN CUPS PER BIN
						QBC111	QBC112
QSB801CL	11-5/8" x 4-3/8" x 8"	10-1/6" x 3" x 8"	36	19 lbs	DSB801	50	6
QSB802CL	11-5/8" x 6-5/8" x 8"	10-1/6" x 5-1/2" x 8"	30	20 lbs	DSB802	50	9
QSB807CL	11-5/8" x 8-3/8" x 8"	10-1/6" x 7-1/8" x 8"	20	17 lbs	DSB807	50	12
QSB809CL	11-5/8" x 11-1/8" x 8"	10-1/6" x 10" x 8"	8	9 lbs	DSB809	50	18
QSB803CL	17-7/8" x 4-3/8" x 8"	16-1/2" x 3" x 8"	20	15 lbs	DSB803	50	9
QSB804CL	17-7/8" x 6-5/8" x 8"	16-1/2" x 5-1/2" x 8"	20	18 lbs	DSB804	50	15
QSB808CL	17-7/8" x 8-3/8" x 8"	16-1/2" x 7-1/8" x 8"	10	13 lbs	DSB808	50	19
QSB810CL	17-7/8" x 11-1/8" x 8"	16-1/2" x 10" x 8"	8	13 lbs	DSB810	50	29
QSB805CL	23-5/8" x 4-3/8" x 8"	22-1/8" x 3" x 8"	16	15 lbs	DSB805	50	13
QSB806CL	23-5/8" x 6-5/8" x 8"	22-1/8" x 5-1/2" x 8"	8	11 lbs	DSB806	50	21
QSB814CL	23-5/8" x 8-3/8" x 8"	22-1/8" x 7-1/8" x 8"	6	11 lbs	DSB814	50	24
QSB816CL	23-5/8" x 11-1/8" x 8"	22-1/8" x 10" x 8"	6	12 lbs	DSB816	50	35



### Dividers and Bin Cups

Optional black dividers fit snugly, horizontally across bins to create compartments. Each bin accepts up to 7 dividers.

Bin cups have a raised, slotted label holder for easy parts identification. The entire bin cup may be removed for easy part retrieval. Available in 2 sizes and 2 colors.

Available in: ● Blue ● Yellow

MODEL NO.	OUTSIDE DIMENSIONS L" x W" x H"	CTN QTY	CTN WGT
QBC111	3-1/4" x 1-3/4" x 3"	48	4 lbs
QBC112	5-1/8" x 2-3/4" x 3"	48	7 lbs



**LOWEST PRICE GUARANTEE**

# COMPLETE PACKAGES WITH BINS



## MOBILIZE YOUR WIRE SHELVING

### DB - Donut Bumper

Non-marking donut bumper used to protect walls and help cushion impact.

### WR-00H (Mobile Kit)\*

Set of four swivel thermoplastic resin 5" x 1-1/4" casters, two with brakes. Up to 1,200 lb. load capacity. \*Mobile kits recommended only for shelves 18" and deeper.



WR4-39-1236-802CL



WR8-802CL

# QUANTUM IS CLEARLY YOUR STORAGE SOLUTION



1239-SB807CL



1275-SB807CL

## Clear-View Complete Bin Center

Complete bin systems are available with 4 different size bin options on a 12"W x 36"L x 39"H unit. This all-purpose bin center is an economical high density storage system that provides easy visibility to stored contents. Bins available in Clear.

Bins available in:  Clear **800 lb. LOAD CAPACITY PER SHELF**

MODEL NO.	NO. OF BINS	BIN DIMENSIONS L" x W" x H"	SHIP WGT
<b>12"W x 36"L x 39"H - 4 Shelf Systems</b>			
WR4-39-1236-801CL	24 QSB801CL	11-5/8" x 4-3/8" x 8"	80 lbs
WR4-39-1236-802CL	15 QSB802CL	11-5/8" x 6-5/8" x 8"	78 lbs
WR4-39-1236-807CL	12 QSB807CL	11-5/8" x 8-3/8" x 8"	77 lbs
WR4-39-1236-809CL	9 QSB809CL	11-5/8" x 11-1/8" x 8"	77 lbs

## Clear-View STORE-MAX 8" Shelf Bin Wire Shelving Systems - Complete Packages

Bins available in:  Clear **800 lb. LOAD CAPACITY PER SHELF**

MODEL NO.	NO. OF BINS	BIN DIMENSIONS L" x W" x H"	SHIP WGT
<b>12"W x 36"L x 74"H - 8 Shelf Systems</b>			
WR8-801CL	49 QSB801CL	11-5/8" x 4-3/8" x 8"	100 lbs
WR8-802CL	35 QSB802CL	11-5/8" x 6-5/8" x 8"	103 lbs
WR8-807CL	28 QSB807CL	11-5/8" x 8-3/8" x 8"	102 lbs
WR8-809CL	21 QSB809CL	11-5/8" x 11-1/8" x 8"	101 lbs
<b>18"W x 36"L x 74"H - 8 Shelf Systems</b>			
WR8-803CL	49 QSB803CL	17-7/8" x 4-3/8" x 8"	150 lbs
WR8-804CL	35 QSB804CL	17-7/8" x 6-5/8" x 8"	142 lbs
WR8-808CL	28 QSB808CL	17-7/8" x 8-3/8" x 8"	138 lbs
WR8-810CL	21 QSB810CL	17-7/8" x 11-1/8" x 8"	141 lbs
<b>24"W x 36"L x 74"H - 8 Shelf Systems</b>			
WR8-805CL	49 QSB805CL	23-5/8" x 4-3/8" x 8"	194 lbs
WR8-806CL	35 QSB806CL	23-5/8" x 6-5/8" x 8"	177 lbs
WR8-814CL	28 QSB814CL	23-5/8" x 8-3/8" x 8"	176 lbs
WR8-816CL	21 QSB816CL	23-5/8" x 11-1/8" x 8"	169 lbs

## Clear-View STORE-MAX 8" Shelf Bin Steel Shelving Systems - Complete Packages

Bins available in:  Clear **400 lb. LOAD CAPACITY PER SHELF**

MODEL NO.	NO. OF BINS	BIN DIMENSIONS L" x W" x H"	SHIP WGT
<b>12"D x 36"W x 75"H - 8 Shelf Systems</b>			
1275-SB801CL	56 QSB801CL	11-5/8" x 4-3/8" x 8"	111 lbs
1275-SB802CL	35 QSB802CL	11-5/8" x 6-5/8" x 8"	103 lbs
1275-SB807CL	28 QSB807CL	11-5/8" x 8-3/8" x 8"	100 lbs
1275-SB809CL	21 QSB809CL	11-5/8" x 11-1/8" x 8"	98 lbs
<b>12"D x 36"W x 39"H - 4 Shelf Systems</b>			
1239-SB801CL	24 QSB801CL	11-5/8" x 4-3/8" x 8"	56 lbs
1239-SB802CL	15 QSB802CL	11-5/8" x 6-5/8" x 8"	52 lbs
1239-SB807CL	12 QSB807CL	11-5/8" x 8-3/8" x 8"	51 lbs
1239-SB809CL	9 QSB809CL	11-5/8" x 11-1/8" x 8"	50 lbs
<b>18"D x 36"W x 75"H - 8 Shelf Systems</b>			
1875-SB803CL	56 QSB803CL	17-7/8" x 4-3/8" x 8"	156 lbs
1875-SB804CL	35 QSB804CL	17-7/8" x 6-5/8" x 8"	141 lbs
1875-SB808CL	28 QSB808CL	17-7/8" x 8-3/8" x 8"	142 lbs
1875-SB810CL	21 QSB810CL	17-7/8" x 11-1/8" x 8"	139 lbs
<b>18"D x 36"W x 39"H - 4 Shelf Systems</b>			
1839-SB803CL	24 QSB803CL	17-7/8" x 4-3/8" x 8"	77 lbs
1839-SB804CL	15 QSB804CL	17-7/8" x 6-5/8" x 8"	70 lbs
1839-SB808CL	12 QSB808CL	17-7/8" x 8-3/8" x 8"	71 lbs
1839-SB810CL	9 QSB810CL	17-7/8" x 11-1/8" x 8"	69 lbs



**Genuine stack and nest totes**



**9 SIZES AVAILABLE**



These heavy-duty, tough, and dependable stack and nest totes are the ultimate reusable container for storing and transporting your valuable items in any application. These proven containers are available in nine sizes for efficiency and inventory control.

Available in:  Clear

MODEL NO.	OUTSIDE DIMENSIONS L" x W" x H"	A	INSIDE DIMENSIONS B C D E	CAPACITY (CU FT)	CTN QTY	CTN WGT	LID	CTN QTY	
snt180CL	18" x 11" x 6"	10"	16" 15-1/4" 9-3/8" 5-7/8"	0.50	6	12 lbs	LID181CL	6	
snt185CL	18" x 11" x 9"	10"	16" 15-1/8" 9-1/8" 8-7/8"	0.76	6	15 lbs	LID181CL	6	
snt190CL	19-1/2" x 15-1/2" x 10"	14-1/2"	17" 16" 13-1/4" 9-7/8"	1.20	6	23 lbs	LID191CL	6	
snt195CL	19-1/2" x 15-1/2" x 13"	14-1/2"	17" 15-7/8" 13-3/8" 12-7/8"	1.70	6	26 lbs	LID191CL	6	
snt200CL	19-1/2" x 13-1/2" x 8"	12-3/8"	17-7/8" 16-3/8" 11-1/2" 7-7/8"	0.80	6	19 lbs	LID201CL	6	
snt225CL	23-1/2" x 19-1/2" x 10"	18-1/4"	20-7/8" 19-3/8" 16-7/8" 9-7/8"	2.00	3	18 lbs	LID231CL	3	
snt230CL	23-1/2" x 19-1/2" x 13"	18-1/8"	20-7/8" 19-1/2" 16-7/8" 12-7/8"	2.60	3	22 lbs	LID231CL	3	
snt240CL	23-1/2" x 15-1/2" x 12"	14-1/4"	20-7/8" 19-5/8" 13" 11-7/8"	1.70	3	18 lbs	LID241CL	3	
snt300CL	29-1/2" x 19-1/2" x 15"	18-1/4"	26-5/8" 25-1/8" 16-5/8" 14-7/8"	3.70	3	31 lbs	LID301CL	3	
snh010	Clear Label Holder - 3" x 5" (Fits all tote sizes)					6	1 lb	-	-



**PERFORMANCE FEATURES:**

- Available in 9 sizes
- Standard color: Clear
- Totes are injection molded from high-density tri-clear virgin-grade polypropylene material that complies with the USDA and FDA regulations
- stack and nest totes will not corrode, bend out of shape, are unaffected by chemicals and are waterproof
- Reusable container will stack with or without lids for maximum storage and shipping
- snt's have the unique ability to stack or they can be turned 180° to nest when empty saving valuable space
- Optional lids for totes can be secured with nylon ties
- Textured bottoms ensure safe and easy, non-slip grip in transit on conveyors

**COMPLETE PACKAGES WITH BINS**

**QUANTUM IS CLEARLY YOUR STORAGE SOLUTION**

**Genuine stack and nest totes Wire Shelving Systems - Complete Packages**

Offering a generous up to 600-800 lb. load capacity per shelf, this chrome wire shelving system with totes is a must have for archival storage, heavy-duty parts organization or inventory control applications. With three packages to choose from offering clear-view bins, this system can be used just about anywhere. System may be made mobile with the addition of the WR-00H mobile kit. See pg. 70 for additional information and to order optional accessories.

Bins available in:  Clear

**Up to 600-800 lb. LOAD CAPACITY PER SHELF**

MODEL NO.	NO. OF SHELVES	NO. OF BINS	BIN DIMENSIONS L" x W" x H"	SHIP WGT
<b>18"W x 48"L x 74"H - Wire Shelving Systems with stack and nest totes - Totes are available in Clear</b>				
WR9-36180CL	9	36 snt180CL	18" x 11" x 6"	178 lbs
WR6-24185CL	6	24 snt185CL	18" x 11" x 9"	136 lbs
<b>24"W x 66"L x 63"H - Wire Shelving System with stack and nest totes - Totes are available in Clear</b>				
WR4-12225CL	4	12 snt225CL	23-1/2" x 19-1/2" x 10"	170 lbs



WR6-24185CL



**MOBILIZE YOUR WIRE SHELVING**

**DB - Donut Bumper**  
Non-marking donut bumper used to protect walls and help cushion impact.

**WR-00H (Mobile Kit)**  
Set of four swivel thermoplastic resin 5" x 1-1/4" casters, two with brakes. Can be used with all units shown. Up to 1,200 lb. load capacity.



**LOWEST PRICE GUARANTEE**

**Clear-View Dividable Grid Containers**



Heavy-duty Dividable Grid Containers can be used for storage, kitting and distribution applications. These containers offer the safest and most efficient method for compartmentalizing and protecting small to medium sized items. Dividers allow you to customize the container's interior to meet your exact needs. Dividers: Gray. Containers and covers are available in Clear.

Available in:  Clear

MODEL NO.	OUTSIDE DIMENSIONS L" x W" x H"	INSIDE DIMENSIONS L" x W" x H"	CTN QTY	CTN WGT
<b>DG91025CL</b>	10-7/8" x 8-1/4" x 2-1/2"	9-3/16" x 6-9/16" x 2"	20	16 lbs
<b>DG91035CL</b>	10-7/8" x 8-1/4" x 3-1/2"	9-3/16" x 6-9/16" x 3"	20	24 lbs
<b>DG91050CL</b>	10-7/8" x 8-1/4" x 5"	9-3/16" x 6-9/16" x 4-1/2"	20	32 lbs
<b>DG92035CL</b>	16-1/2" x 10-7/8" x 3-1/2"	14-7/8" x 9-1/4" x 3"	12	23 lbs
<b>DG92050CL</b>	16-1/2" x 10-7/8" x 5"	14-7/8" x 9-1/4" x 4-1/2"	12	25 lbs
<b>DG92060CL</b>	16-1/2" x 10-7/8" x 6"	14-7/8" x 9-1/4" x 5-1/2"	8	20 lbs
<b>DG92080CL</b>	16-1/2" x 10-7/8" x 8"	14-7/8" x 9-1/4" x 7-1/2"	8	27 lbs
<b>DG93030CL</b>	22-1/2" x 17-1/2" x 3"	20-5/8" x 15-5/8" x 2-1/2"	6	20 lbs
<b>DG93060CL</b>	22-1/2" x 17-1/2" x 6"	20-5/8" x 15-5/8" x 5-1/2"	3	16 lbs
<b>DG93080CL</b>	22-1/2" x 17-1/2" x 8"	20-5/8" x 15-5/8" x 7-1/2"	3	19 lbs
<b>DG93120CL</b>	22-1/2" x 17-1/2" x 12"	20-5/8" x 15-5/8" x 11-1/2"	3	23 lbs



**Clear Dividable Grid Container**

Shown with optional cover  
see **pg. 69**  
(Sold separately)



**Clear Dividable Grid Container**

Shown with optional dividers  
see **pg. 69**  
(Sold separately)



**COMPLETE PACKAGES WITH BINS**



**MOBILIZE YOUR WIRE SHELVING**

**DB - Donut Bumper**

Non-marking donut bumper used to protect walls and help cushion impact.

**WR-00H (Mobile Kit)**

Set of four swivel thermoplastic resin 5" x 1-1/4" casters, two with brakes. Can be used with all units shown. Up to 1,200 lb. load capacity.



**WR7-92080CL**

**Clear-View Dividable Grid Container Wire Shelving Systems - Complete Packages**

Durable chrome wire shelving combined with Quantum's Clear-View Dividable Grid Containers. These containers allow for multiple compartment configurations within each bin. Offering four different packages, these systems are ideal for small, medium and large parts storage. System may be made mobile with the addition of the **WR-00H** mobile kit. See **pg. 69** for additional information and to order optional accessories.

Bins available in:  Clear



**600-800 lb. LOAD CAPACITY PER SHELF**

MODEL NO.	NO. OF SHELVES	NO. OF BINS	BIN DIMENSIONS L" x W" x H"	SHIP WGT
<b>18"W x 48"L x 74"H - Wire Shelving Systems</b>				
<b>WR9-92060CL</b>	9	36 DG92060CL	16-1/2" x 10-7/8" x 6"	210 lbs
<b>WR7-92080CL</b>	7	24 DG92080CL	16-1/2" x 10-7/8" x 8"	174 lbs
<b>24"W x 60"L x 63"H - Wire Shelving Systems</b>				
<b>WR12-93030CL</b>	12	36 DG93030CL	22-1/2" x 17-1/2" x 3"	274 lbs
<b>24"W x 60"L x 74"H - Wire Shelving Systems</b>				
<b>WR9-93060CL</b>	8	24 DG93060CL	22-1/2" x 17-1/2" x 6"	254 lbs

**Bin Carts**

Modular carts are the ultimate work-in-process and transport cart. Dividable grids slide easily in and out and with their ability to be divided into multiple compartments with long and short dividers, see **pg. 69** for dividers and label holders. Double and Triple Bay Carts are also available, see **pg. 137**. Dividable grids are available in Clear.  
**Cart Finish:** Chrome

MODEL NO.	NO. OF BINS	BIN DIMENSIONS L" x W" x H"	SHIP WGT
<b>21"W x 24"L x 45"H - Bin Cart with Dividable Grid Containers</b>			
<b>BC212434M1CL</b>	4 DG93060CL	22-1/2" x 17-1/2" x 6"	58 lbs
<b>BC212439M2CL</b>	7 DG93030CL	22-1/2" x 17-1/2" x 3"	79 lbs
<b>21"W x 24"L x 69"H - Bin Cart with Dividable Grid Containers</b>			
<b>BC212469M1CL</b>	7 DG93060CL	22-1/2" x 17-1/2" x 6"	107 lbs
<b>BC212469M2CL</b>	11 DG93030CL	22-1/2" x 17-1/2" x 3"	111 lbs
<b>21"W x 24"L x 45"H - Bin Cart with No Dividable Grid Containers</b>			
<b>BC212439M4</b>	No Containers (Includes slides for 4 bin levels)		46 lbs
<b>BC212439M7</b>	No Containers (Includes slides for 7 bin levels)		55 lbs
<b>21"W x 24"L x 69"H - Bin Cart with No Dividable Grid Containers</b>			
<b>BC212469M</b>	No Containers (Includes slides for 7 bin levels)		63 lbs
<b>BC212469M11</b>	No Containers (Includes slides for 11 bin levels)		75 lbs
<b>WR-S24W</b>	-	One Pair - 24" Wire Bin Slides	3 lbs

**QUANTUM IS CLEARLY YOUR STORAGE SOLUTION**



**BC212434M1CL**



**Clear Dust Cover Acrylic Inlays**

Clear Acrylic Dust Cover Inlays keep stored items visible while protecting against airborne dust and other contaminants. Cover lays inside on recessed rim of container.

MODEL NO.	FITS BIN MODEL NO.	CTN QTY
<b>DDC91000CL</b>	DG91025CL, DG91035CL, DG91050CL	10
<b>DDC92000CL</b>	DG92035CL, DG92050CL, DG92060CL, DG92080CL	4
<b>DDC93000CL</b>	DG93030CL, DG93060CL, DG93080CL, DG93120CL	3

STACKABLE SHELF BIN

10 SIZES AND 5 COLORS AVAILABLE



Exclusive! Stackable Shelf Bins



Quantum's exclusive Stackable Shelf Bins are an industry first and are ideal for medium size and large item storage. These strong, durable polypropylene bins are available in 4 lengths and 3 widths. 12", 14" and 18" deep bins have a built in rear hanger which allows bin to hang from louvered panels and rails. Bins have a raised front opening when compared to any like product allowing you to truly maximize the complete bin's storage capacity. Optional cross dividers allow flexibility and keep parts organized. Waterproof bins resist rust and corrosion. Large molded in front label slots for ID labels. Autoclavable up to 250°F and resistant to extreme cold.

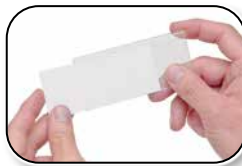

LTR-2400 Clear Label Holder and Insert Package of 25.



STACKABLE SHELF BIN Shown with optional Divider and DLT-6 Divider Label Tabs attach to existing dividers to improve the visibility of bin labels and scanning of barcodes. Package of 6. (Dividers and Label Tabs sold separately)

Available in: ● Blue ● Gray ● Ivory ● Black ● Orange

MODEL NO.	OUTSIDE DIMENSIONS L" x W" x H"	INSIDE DIMENSIONS L" x W" x H"	X"	CTN QTY	CTN WGT	DIVIDER	CTN QTY	CTN WGT	CLEAR LABEL HOLDER & INSERT
SSB423	12" x 8-1/4" x 7"	11-1/2" x 7-3/8" x 6-1/2"	7-1/2"	6	9 lbs	DSS403	6	1 lb	LTR-2400
SSB425	12" x 11" x 7"	11-1/2" x 10-1/8" x 6-1/2"	7-1/2"	6	11 lbs	DSS405	6	2 lbs	LTR-2400
SSB441	14" x 6" x 7"	13-1/2" x 5-3/8" x 6-1/2"	9-3/8"	6	8 lbs	DSS401	6	1 lb	LTR-2400
SSB443	14" x 8-1/4" x 7"	13-1/2" x 7-3/8" x 6-1/2"	9-3/8"	12	18 lbs	DSS403	6	1 lb	LTR-2400
SSB445	14" x 11" x 7"	13-1/2" x 10-1/8" x 6-1/2"	9-3/8"	6	12 lbs	DSS405	6	2 lbs	LTR-2400
SSB461	18" x 6" x 7"	17-1/2" x 5-3/8" x 6-1/2"	13-1/2"	6	11 lbs	DSS401	6	1 lb	LTR-2400
SSB463	18" x 8-1/4" x 7"	17-1/2" x 7-3/8" x 6-1/2"	13-3/8"	6	12 lbs	DSS403	6	1 lb	LTR-2400
SSB465	18" x 11" x 7"	17-1/2" x 10-1/8" x 6-1/2"	13-3/8"	6	15 lbs	DSS405	6	2 lbs	LTR-2400
SSB483*	20-1/2" x 8-1/4" x 7"	20" x 7-3/8" x 6-1/2"	15-7/8"	6	14 lbs	DSS403	6	1 lb	LTR-2400
SSB485*	20-1/2" x 11" x 7"	20" x 10-1/8" x 6-1/2"	15-7/8"	6	17 lbs	DSS405	6	2 lbs	LTR-2400

\*Do not have rear hanger. To order a full carton add CS suffix to Model No. SSB423BLCS. Note: Bins must be ordered in carton quantities only.

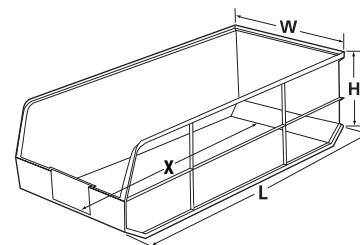

Bin Dimensions Guide L (length) W (width) H (height) X (inside length)

PERFORMANCE FEATURES:

- Available in 10 sizes
- Standard colors: Blue, Gray, Ivory, Black and Orange (additional colors available on request, subject to upcharge and minimum runs)
- Bins are made from heavy-duty, virgin, high density FDA approved polypropylene
- Large label slot provide easy label insertion and parts identification
- Extra wide stacking ledge assures stability for high stacking
- Reinforced design adds strength and prevents spreading
- Will not rust or corrode, unaffected by weak acids and alkalis, and are waterproof
- Autoclavable up to 250°F



**Up to 400 lb.**  
**LOAD CAPACITY**  
**PER SHELF**



**2475-485**  
24"D x 36"W x 75"H  
8 shelves and 21 SSB485  
20-1/2"L x 11"W x 7"H bins

**Stackable Shelf Bin Steel Shelving Systems**  
- Complete Packages

Bins available in: ● Blue ● Gray ● Ivory ● Black ● Orange

(One color per unit)

MODEL NO.	OUTSIDE DIMENSIONS D" x W" x H"	NO. OF SHELVES	NO. OF BINS	BIN DIMENSIONS L" x W" x H"	SHIP WGT
1275-423	12" x 36" x 75"	8	28 SSB423	12" x 8-1/4" x 7"	129 lbs
1275-425	12" x 36" x 75"	8	21 SSB425	12" x 11" x 7"	126 lbs
1275-441	12" x 36" x 75"	8	35 SSB441	14" x 6" x 7"	134 lbs
1275-443	12" x 36" x 75"	8	28 SSB443	14" x 8-1/4" x 7"	129 lbs
1275-445	12" x 36" x 75"	8	21 SSB445	14" x 11" x 7"	129 lbs
1875-461	18" x 36" x 75"	8	35 SSB461	18" x 6" x 7"	173 lbs
1875-463	18" x 36" x 75"	8	28 SSB463	18" x 8-1/4" x 7"	165 lbs
1875-465	18" x 36" x 75"	8	21 SSB465	18" x 11" x 7"	165 lbs
2475-483	24" x 36" x 75"	8	28 SSB483	20-1/2" x 8-1/4" x 7"	197 lbs
2475-483485	24" x 36" x 75"	8	12 SSB483 12 SSB485	20-1/2" x 8-1/4" x 7" 20-1/2" x 11" x 7"	195 lbs
2475-485	24" x 36" x 75"	8	21 SSB485	20-1/2" x 11" x 7"	194 lbs

**COMPLETE PACKAGES**  
**WITH BINS**



**MOBILIZE YOUR WIRE SHELVING**

**DB - Donut Bumper**  
Non-marking donut bumper used to protect walls and help cushion impact.

**WR-00H (Mobile Kit)\***  
Set of four swivel thermoplastic resin 5" x 1-1/4" casters, two with brakes. Up to 1,200 lb. load capacity. \*Mobile kits recommended only for shelves 18" and deeper.



**WR8-463**  
18"W x 36"L x 74"H  
8 shelves and 28 SSB463  
18"L x 8-1/4"W x 7"H bins



**Stackable Shelf Bin Wire Shelving Systems**  
- Complete Packages

**Up to 800 lb.**  
**LOAD CAPACITY**  
**PER SHELF**

Bins available in: ● Blue ● Gray ● Ivory ● Black ● Orange (One color per unit)

MODEL NO.	OUTSIDE DIMENSIONS W" x L" x H"	NO. OF SHELVES	NO. OF BINS	BIN DIMENSIONS L" x W" x H"	SHIP WGT
WR8-423	12" x 36" x 74"	8	28 SSB423	12" x 8-1/4" x 7"	114 lbs
WR8-425	12" x 36" x 74"	8	21 SSB425	12" x 11" x 7"	107 lbs
WR8-441	14" x 36" x 74"	8	35 SSB441	14" x 6" x 7"	136 lbs
WR8-443	14" x 36" x 74"	8	28 SSB443	14" x 8-1/4" x 7"	129 lbs
WR8-445	14" x 36" x 74"	8	21 SSB445	14" x 11" x 7"	122 lbs
WR8-461	18" x 36" x 74"	8	35 SSB461	18" x 6" x 7"	190 lbs
WR8-463	18" x 36" x 74"	8	28 SSB463	18" x 8-1/4" x 7"	180 lbs
WR8-465	18" x 36" x 74"	8	21 SSB465	18" x 11" x 7"	184 lbs
WR8-483	21" x 36" x 74"	8	28 SSB483	20-1/2" x 8-1/4" x 7"	198 lbs
WR8-483485	21" x 36" x 74"	8	12 SSB483 12 SSB485	20-1/2" x 8-1/4" x 7" 20-1/2" x 11" x 7"	199 lbs
WR8-485	21" x 36" x 74"	8	21 SSB485	20-1/2" x 11" x 7"	198 lbs

# HULK containers

10 SIZES AND 4 COLORS AVAILABLE

Up to **300 lb.**  
MAX CAPACITY  
PER BIN



**REAR LARGE HANDLE**  
Molded onto back of containers makes them easy to carry!

**CLEAR VIEW**  
AVAILABLE on pg. 24



**QUS957**  
Shown with optional cross divider



**AL-23**  
2" x 3-1/2"  
Adhesive clear label holder and inserts.  
Package of 24  
(Sold separately)



**POLYMER DOLLY**  
**DLY-3018** Dolly with padded rubber trim, available in Blue. Dimensions 30"L x 18"W. Set of four 4" x 1-1/4" non-marking swivel poly casters. Up to 1,000 lb. load capacity. (Bin sold separately)



**ATTACHED PULL RING**  
allows dolly to be pulled with ease



**MOBILE HULK CONTAINER**  
Ideal for transport of heavy and bulky parts. Bin comes with 4 swivel, 3" polyurethane casters, all with brakes, allowing up to 250 lb. mobile load capacity

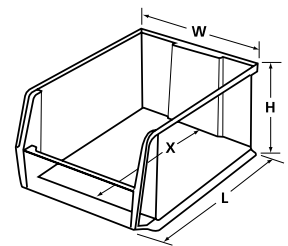

**Bin Dimensions Guide**  
L (length) W (width)  
H (height) X (inside length)

**HULK 24" Containers**



Organize and store your large and bulky items with these strong injection molded polypropylene, stackable containers. These extra large stacking containers offer a generous 2 feet in length to store your larger items. These huge stack bins are ideal for heavy-duty, extra deep shelving and are available in a variety of widths and heights. Heavy-duty front, back and side grips allow for easy handling. Optional clear styrene plastic window increases bin capacity and provides a quick view of the bin contents. Optional dividers maximize flexibility and keep contents organized. All bins have three divider slots except for 8-1/4" wide bins which only have one slot. Wide stacking ledge and anti-slide lock keep stacked bins steady and prevent forward shifting. Waterproof bins are corrosion free. Bins are autoclavable up to 250°F and are resistant to extreme cold.

Available in: ● Blue ● Red ● Yellow ● Clear

MODEL NO.	OUTSIDE DIMENSIONS L" x W" x H"	INSIDE DIMENSIONS L" x W" x H"	X"	CTN QTY	CTN WGT	MAX CAP	CLEAR WINDOW	CTN QTY	DIVIDER & CROSS DIVIDER	CTN QTY	CLEAR LABEL HOLDER & INSERT	CTN QTY
QUS950	23-7/8" x 8-1/4" x 7"	21-7/8" x 6-1/4" x 6-5/8"	19"	6	18 lbs	250 lbs	WUS950/970	6	DUS950	6	-	-
QUS951	23-7/8" x 8-1/4" x 9"	21-7/8" x 6-1/4" x 8-3/4"	18-3/4"	6	21 lbs	250 lbs	WUS951	6	DUS951	6	-	-
QUS952	23-7/8" x 11" x 7"	21-7/8" x 9" x 6-7/8"	19"	4	14 lbs	250 lbs	WUS952	4	DUS952	6	-	-
QUS953	23-7/8" x 11" x 10"	21-1/2" x 8-7/8" x 9-3/4"	18-3/4"	4	18 lbs	350 lbs	WUS953/973	4	DUS953	6	-	-
QUS954	23-7/8" x 16-1/2" x 11"	21-7/8" x 14-1/4" x 10-3/4"	18-3/4"	1	7 lbs	350 lbs	WUS954/974	1	DUS954	6	AL-23	24
QUS964MOB*	23-7/8" x 16-1/2" x 11"	21-7/8" x 14-1/4" x 10-3/4"	18-3/4"	1	9 lbs	350 lbs	WUS954/974	1	DUS954	6	AL-23	24
QUS955	23-7/8" x 18-1/4" x 12"	21-1/2" x 16" x 11-3/4"	17-3/4"	1	8 lbs	350 lbs	WUS955/975	1	DUS955	6	AL-23	24
QUS965MOB*	23-7/8" x 18-1/4" x 12"	21-1/2" x 16" x 11-3/4"	17-3/4"	1	10 lbs	350 lbs	WUS955/975	1	DUS955	6	AL-23	24
QUS957	23-7/8" x 22-1/2" x 12"	21-1/8" x 20-1/2" x 11-3/8"	18"	1	8 lbs	350 lbs	WUS957	1	DUS957 CRDUS957	6	AL-23	24
QUS967MOB*	23-7/8" x 22-1/2" x 12"	21-1/8" x 20-1/2" x 11-3/8"	18"	1	10 lbs	350 lbs	WUS957	1	DUS957 CRDUS957	6	AL-23	24

\*With caster, overall height for mobile container will be increased by 3"

**Up to 350 lb.** LOAD CAPACITY PER SHELF

HULK 24" Container Steel Shelving Systems - Complete Packages



**2475-950**  
24"D x 36"W x 75"H  
8 shelves and 28 QUS950  
23-7/8"L x 8-1/4"W x 7"H bins



**2475-951**  
24"D x 36"W x 75"H  
7 shelves and 24 QUS951  
23-7/8"L x 8-1/4"W x 9"H bins



**2475-952**  
24"D x 36"W x 75"H  
8 shelves and 21 QUS952  
23-7/8"L x 11"W x 7"H bins



**2475-953**  
24"D x 36"W x 75"H  
6 shelves and 15 QUS953  
23-7/8"L x 11"W x 10"H bins



**2475-954**  
24"D x 36"W x 75"H  
6 shelves and 10 QUS954  
23-7/8"L x 16-1/2"W x 11"H bins



**2475-950952**  
24"D x 36"W x 75"H  
8 shelves and 12 QUS950  
23-7/8"L x 8-1/4"W x 7"H bins  
and 12 QUS952  
23-7/8"L x 11"W x 7"H bins



**2475-953954**  
24"D x 36"W x 75"H  
6 shelves and 9 QUS953  
23-7/8"L x 11"W x 10"H bins  
and 4 QUS954  
23-7/8"L x 16-1/2"W x 11"H bins



**2475-20-MIX**  
24"D x 36"W x 75"H  
7 shelves and 8 QUS950  
23-7/8"L x 8-1/4"W x 7"H bins  
and 3 QUS952  
23-7/8"L x 11"W x 7"H bins  
and 4 QUS951  
23-7/8"L x 8-1/4"W x 9"H bins  
and 3 QUS953  
23-7/8"L x 11"W x 10"H bins  
and 2 QUS954  
23-7/8"L x 16-1/2"W x 11"H bins

**CLEAR VIEW**  
AVAILABLE on pg. 24

**COMPLETE PACKAGES WITH BINS**

**HULK**  
containers

Bins available in: Blue Red Yellow Clear (One color per unit)



**HULK 24" Container Wire Shelving Systems - Complete Packages**

**Up to 800 lb. LOAD CAPACITY PER SHELF**



**WR8-950**  
24"W x 36"L x 74"H  
8 shelves and 28 QUS950  
23-7/8"L x 8-1/4"W x 7"H bins



**WR7-951**  
24"W x 36"L x 74"H  
7 shelves and 24 QUS951  
23-7/8"L x 8-1/4"W x 9"H bins



**WR8-952**  
24"W x 36"L x 74"H  
8 shelves and 21 QUS952  
23-7/8"L x 11"W x 7"H bins



**WR6-953**  
24"W x 36"L x 74"H  
6 shelves and 15 QUS953  
23-7/8"L x 11"W x 10"H bins



**WR6-954**  
24"W x 36"L x 74"H  
6 shelves and 10 QUS954  
23-7/8"L x 16-1/2"W x 11"H bins



**WR5-955**  
24"W x 42"L x 74"H  
5 shelves and 8 QUS955  
23-7/8"L x 18-1/4"W x 12"H bins



**WR6-957**  
24"W x 48"L x 74"H  
6 shelves and 10 QUS957  
23-7/8"L x 22-1/2"W x 12"H bins



**WR7-20-MIX**  
24"W x 36"L x 74"H  
7 shelves and 8 QUS950  
23-7/8"L x 8-1/4"W x 7"H bins  
and 3 QUS952  
23-7/8"L x 11"W x 7"H bins  
and 4 QUS951  
23-7/8"L x 8-1/4"W x 9"H bins  
and 3 QUS953  
23-7/8"L x 11"W x 10"H bins  
and 2 QUS954 bins  
23-7/8"L x 16-1/2"W x 11"H bins



**MOBILIZE YOUR WIRE SHELVING**

**DB - Donut Bumper**  
Non-marking donut bumper used to protect walls and help cushion impact.

**WR-00H (Mobile Kit)**  
Set of four swivel thermoplastic resin 5" x 1-1/4" casters, two with brakes. Can be used with all units shown. Up to 1,200 lb. load capacity.

**CLEARVIEW**  
AVAILABLE on pg. 24

**HULK**  
containers

Bins available in: ● Blue ● Red ● Yellow ● Clear (One color per unit)



**LOWEST PRICE GUARANTEE**

# 14 SIZES AND 3 COLORS AVAILABLE

## HEAVY-DUTY

**Up to 300 lb. MAX CAPACITY PER BIN**

QUS974

# HULK containers

QUS973



QUS976

QUS975



QUS970



29-7/8" L

**ADHESIVE CLEAR LABEL HOLDER AND INSERTS**

**AL-23**

2" x 3-1/2"

(Fits bins 12"H and shorter)

**AL-35**

3" x 5"

(Fits bins 15"H and taller)

Package of 24

(Sold separately)



LABEL  
3" x 5"

35-7/8" L

QUS997

**REAR LARGE HANDLE**

Molded onto back of containers makes them easy to carry!



**CLEAR PLASTIC WINDOW FRONT**

Increases bin capacity and provides a quick view of the bin contents. (Sold separately)

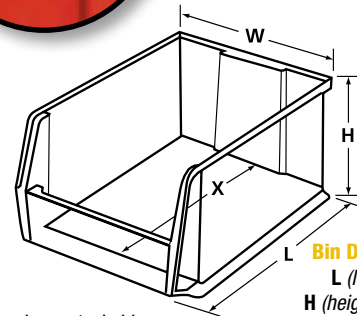

### HULK 30" & 36" Containers



Organize and store your large and bulky items with these strong injection molded high impact polypropylene, stackable containers. These extra large stacking containers offer a generous 2-1/2 - 3 feet in length to store your larger items. These huge stack bins are ideal for heavy-duty, extra deep shelving and are available in a variety of widths and heights. Heavy-duty front, back and side grips allow for easy handling. Wide stacking ledge and anti-slide lock keep stacked bins steady and prevent forward shifting. All bins have three divider slots except for 8-1/4" wide bins which only have one slot. Waterproof bins are corrosion-free. Bins are autoclavable up to 250°F and are resistant to extreme cold.

Available in: ● Blue ● Red ● Yellow

MODEL NO.	OUTSIDE DIMENSIONS L" x W" x H"	INSIDE DIMENSIONS L" x W" x H"	X"	CTN QTY	CTN WGT	CLEAR WINDOW	CTN QTY DIVIDER	CTN QTY
<b>HULK 30" Containers</b>								
QUS970	29-7/8" x 8-1/4" x 7"	27-7/8" x 6-1/4" x 6-3/4"	25"	6	23 lbs	WUS950/970	6	DUS970 6
QUS973	29-7/8" x 11" x 10"	27-7/8" x 8-7/8" x 9-5/8"	24-3/4"	4	22 lbs	WUS953/973	4	DUS973 4
QUS974	29-7/8" x 16-1/2" x 11"	27-5/8" x 14-1/4" x 10-5/8"	24-3/4"	1	8 lbs	WUS954/974	1	DUS974 1
QUS984MOB	29-7/8" x 16-1/2" x 11"	27-5/8" x 14-1/4" x 10-5/8"	24-3/4"	1	10 lbs	WUS954/974	1	DUS974 1
QUS975	29-7/8" x 18-1/4" x 12"	27-1/2" x 16" x 11-3/4"	23-3/4"	1	9 lbs	WUS955/975	1	DUS975 1
QUS985MOB	29-7/8" x 18-1/4" x 12"	27-1/2" x 16" x 11-3/4"	23-3/4"	1	11 lbs	WUS955/975	1	DUS975 1
QUS976	29-7/8" x 16-1/2" x 15"	27-3/8" x 14" x 14-3/4"	23-1/2"	1	10 lbs	WUS976	1	DUS976 1
QUS986MOB	29-7/8" x 16-1/2" x 15"	27-3/8" x 14" x 14-3/4"	23-1/2"	1	12 lbs	WUS976	1	DUS976 1
<b>HULK 36" Containers</b>								
QUS993	35-7/8" x 16-1/2" x 17-1/2"	33-1/8" x 14" x 17-1/4"	28-1/4"	1	14 lbs	-	-	DUS993 1
QUS994MOB	35-7/8" x 16-1/2" x 17-1/2"	33-1/8" x 14" x 17-1/4"	28-1/4"	1	16 lbs	-	-	DUS993 1
QUS995	35-7/8" x 19-7/8" x 17-1/2"	33-1/8" x 17-3/8" x 17-1/4"	28-1/4"	1	15 lbs	-	-	DUS995 1
QUS996MOB	35-7/8" x 19-7/8" x 17-1/2"	33-1/8" x 17-3/8" x 17-1/4"	28-1/4"	1	17 lbs	-	-	DUS995 1
QUS997	35-7/8" x 23-7/8" x 17-1/2"	33-1/4" x 21-3/8" x 17-1/4"	28-1/4"	1	18 lbs	-	-	DUS997 1
QUS998MOB	35-7/8" x 23-7/8" x 17-1/2"	33-1/4" x 21-3/8" x 17-1/4"	28-1/4"	1	20 lbs	-	-	DUS997 1

\*With caster, overall height for mobile container will be increased by 3"



**HULK 30" Container Wire Shelving Systems - Complete Packages**

**Up to 800 lb. LOAD CAPACITY PER SHELF**



**WR8-970**  
30"W x 36"L x 74"H  
8 shelves and 28 QUS970  
29-7/8"L x 8-1/4"W x 7"H bins



**WR6-973**  
30"W x 36"L x 74"H  
6 shelves and 15 QUS973  
29-7/8"L x 11"W x 10"H bins



**WR6-974**  
30"W x 36"L x 74"H  
6 shelves and 10 QUS974  
29-7/8"L x 16-1/2"W x 11"H bins



**WR6-973974**  
30"W x 36"L x 74"H  
6 shelves and 9 QUS973  
and 4 QUS974  
29-7/8"L x 11"W x 10"H bins  
and 29-7/8"L x 16-1/2"W x 11"H bins

**HULK**  
containers

**QUANTUM CHROME  
WIRE SHELVING  
SYSTEMS COMPLETE  
WITH BINS**



**MOBILIZE YOUR WIRE SHELVING**

**DB - Donut Bumper**  
Non-marking donut bumper used to protect walls and help cushion impact.

**WR-00H (Mobile Kit)**  
Set of four swivel thermoplastic resin 5" x 1-1/4" casters, two with brakes. Can be used with all units shown. Up to 1,200 lb. load capacity.

Bins available in: ● Blue ● Red ● Yellow (One color per unit)



**WR5-975**  
30"W x 42"L x 74"H  
5 shelves and 8 QUS975  
29-7/8"L x 18-1/4"W x 12"H bins

HULK 36" Container Wire Shelving Systems - Complete Packages



**WR5-993**  
36"W x 36"L x 86"H  
5 shelves and 8 QUS993  
35-7/8"L x 16-1/2"W x 17-1/2"H bins

**HULK**  
containers

ON  
**SHELVING**

**SIZE**  
DOES MATTER



**WR5-995**  
36"W x 48"L x 86"H  
5 shelves and 8 QUS995  
35-7/8"L x 19-7/8"W x 17-1/2"H bins

**Up to 600 lb.**  
LOAD CAPACITY  
PER SHELF

**QUANTUM CHROME**  
WIRE SHELVING  
SYSTEMS COMPLETE  
WITH BINS



**MOBILIZE YOUR WIRE SHELVING**

**DB - Donut Bumper**  
Non-marking donut bumper used to protect walls and help cushion impact.

**WR-00H (Mobile Kit)**  
Set of four swivel thermoplastic resin 5" x 1-1/4" casters, two with brakes. Can be used with all units shown. Up to 1,200 lb. load capacity.



**WR5-997**  
36"W x 60"L x 86"H  
5 shelves and 8 QUS997  
35-7/8"L x 23-7/8"W x 17-1/2"H bins

Bins available in: ● Blue ● Red ● Yellow (One color per unit)

**RackBin 42" Containers**



- These extra large bins offer a generous 42" (3-1/2 Feet) in length to store your larger items
- 42" length ensures no wasted space on 42" deep pallet rack
- Heavy-duty front, back and side grips allow for easy handling
- Wide stacking ledge and anti-slide lock keep stack bins steady and prevent forward shifting
- Have eight 1/4" drill hole pattern on bottom of bin for easy hole insertion for drainage and air circulation if needed
- Waterproof bins are corrosion free



**RACKBIN**<sup>42"</sup>



**AL-35**  
 3" x 5"  
 Adhesive clear label holder and inserts. Package of 24 (Sold separately)  
 Smooth label area

**Up to 180 lb.**  
**MAX CAPACITY PER BIN**

Available in: ● Blue ● Gray

MODEL NO.	OUTSIDE DIMENSIONS L" x W" x H"	INSIDE DIMENSIONS L" x W" x H"	X"	CTN QTY	CTN WGT
QRB166	41-7/8" x 16-1/2" x 17-1/2"	40-1/8" x 14" x 16-1/2"	35"	1	16 lbs
QRB176MOB	41-7/8" x 16-1/2" x 17-1/2"	40-1/8" x 14" x 16-1/2"	35"	1	18 lbs
QRB206	41-7/8" x 19-7/8" x 17-1/2"	40-1/8" x 17-3/8" x 16-1/2"	35"	1	17 lbs
QRB216MOB	41-7/8" x 19-7/8" x 17-1/2"	40-1/8" x 17-3/8" x 16-1/2"	35"	1	19 lbs
QRB246	41-7/8" x 23-7/8" x 17-1/2"	40-1/8" x 21-1/2" x 16-1/2"	35"	1	19 lbs
QRB256MOB	41-7/8" x 23-7/8" x 17-1/2"	40-1/8" x 21-1/2" x 16-1/2"	35"	1	21 lbs

\*With caster, overall height for mobile container will be increased by 3"

41-7/8"L



**Bin Dimensions Guide**  
 L (length) W (width)  
 H (height) X (inside length)

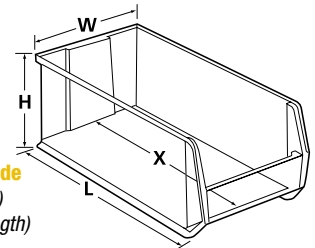

**3 SIZES AND 2 COLORS AVAILABLE**



**THE FIRST AND ONLY BIN DESIGNED SPECIFICALLY TO FIT PALLET RACK**

RackBin 42" Container Wire Shelving Systems - Complete Packages



WRA86-2142C-206



WRA86-2136C-166



**Up to 800 lb.** LOAD CAPACITY PER SHELF

**COMPLETE PACKAGES  
WITH BINS**

Bins available in: ● Blue ● Gray (One color per unit)

MODEL NO.	DIMENSIONS W" x L" x H"	NO. OF CONTAINERS	CONTAINER SIZE L" x W" x H"	SHIP WGT
WRA86-2136C-166	42" x 36" x 86"	8 QRB166	41-7/8" x 16-1/2" x 17-1/2"	272 lbs
WRA86-2142C-206	42" x 42" x 86"	8 QRB206	41-7/8" x 19-7/8" x 17-1/2"	290 lbs
WRA86-2154C-166	42" x 54" x 86"	12 QRB166	41-7/8" x 16-1/2" x 17-1/2"	386 lbs

# 5 SIZES AND 6 COLORS AVAILABLE

**CLEAR VIEW**  
BINS

AVAILABLE on pg. 25

QGH600



QGH700



QGH800



Smooth label area

Large and comfortable side grip handles allow for easy carrying and handling

AL-23

2" x 3-1/2"  
Adhesive clear label holder and inserts.  
Package of 24  
(Sold separately)



Curved lip and corners provide added strength

Large label holder allows for quick part identification

LTR-700

Clear label holders and laser label inserts slide into front label slot of all bins.  
(Sold in packages of 25)



Up to **150 lb.**  
STACK CAPACITY  
PER BIN

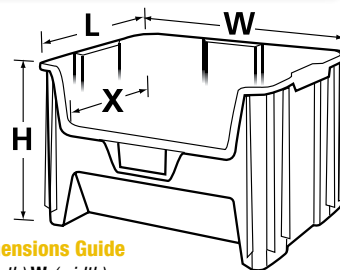

**Bin Dimensions Guide**  
L (length) W (width)  
H (height) X (inside length)

Ribs on side of bin provide added stability when stacked

## Giant Stack Containers



Multipurpose, wide open hopper front provides easy access for large part storage. Ideal for multiple applications in recycling, storing parts and components. This bin will stack up to 6 bins high creating a sturdy, tall storage system. Bins are injection molded from high density polypropylene, easy to clean, resist corrosion and are impervious to most chemicals. Large label holder allows for quick identification. Optional clear window front increases storage capacity and allows for quick identification of parts. Six 1/4" drill hole pattern on bottom of bin allow for easy hole insertion for drainage and air circulation. See **pg. 25** to order Clear Bins.

QGH700 available in: ● Blue ● Ivory ● Red ● Black ● Gray ● Clear

QGH600 and QGH800 available in: ● Blue ● Red ● Gray ● Clear

MODEL NO.	OUTSIDE DIMENSIONS L" x W" x H"	INSIDE DIMENSIONS L" x W" x H"	X"	CAP CU FT	CAP GAL	CTN QTY	CTN WGT	WINDOW	CTN QTY
QGH600	17-1/2" x 10-7/8" x 12-1/2"	15-5/8" x 8" x 12-1/4"	13-1/2"	0.98	7.40	4	12 lbs	<b>WGH600</b>	4
QGH700	15-1/4" x 19-7/8" x 12-7/16"	13-5/8" x 17-1/2" x 12-1/4"	11-1/2"	1.70	12.70	3	13 lbs	<b>WGH700</b>	3
QGH800	17-1/2" x 16-1/2" x 12-1/2"	15-5/8" x 13-3/4" x 12-1/4"	13-1/2"	1.60	12.00	2	8 lbs	<b>WGH800</b>	2

## PERFORMANCE FEATURES:

- Extra thick side walls with reinforced ribs designed for strength, allowing for up to 150 lb. stack capacity per bin
- Large side grip handles
- Stacks 6 bins high
- Six 1/4" drill hole pattern on bottom of bin allows for easy hole insertion for drainage

## Mobile Giant Stack Containers



- Ideal for transport of heavy and bulky parts
- Container comes with 4 swivel, 3" polyurethane casters, all with brakes, allowing for up to 250 lb. mobile load capacity
- Containers can stack with casters in place

QGH705MOB



QGH805MOB



QGH705MOB available in: ● Blue ● Ivory ● Red ● Black ● Gray ● Clear

QGH805MOB available in: ● Blue ● Red ● Gray ● Clear

MODEL NO.	OUTSIDE DIMENSIONS L" x W" x H"	INSIDE DIMENSIONS L" x W" x H"	X"	CAP CU FT	CTN QTY	CTN WGT	WINDOW	CTN QTY
QGH705MOB	15-1/4" x 19-7/8" x 12-7/16"	13-5/8" x 17-1/2" x 12-1/4"	11-1/2"	1.7	3	22 lbs	<b>WGH700</b>	3
QGH805MOB	17-1/2" x 16-1/2" x 12-1/2"	15-5/8" x 13-3/4" x 12-1/4"	13-1/2"	1.6	2	17 lbs	<b>WGH800</b>	2

\*With caster, overall height for mobile container will be increased by 3"



**CLEAR PLASTIC WINDOW FRONT**

Increases bin capacity and provides a quick view of the bin contents.  
(Sold separately)

**Giant Stack Container Storage Center - Complete Packages**

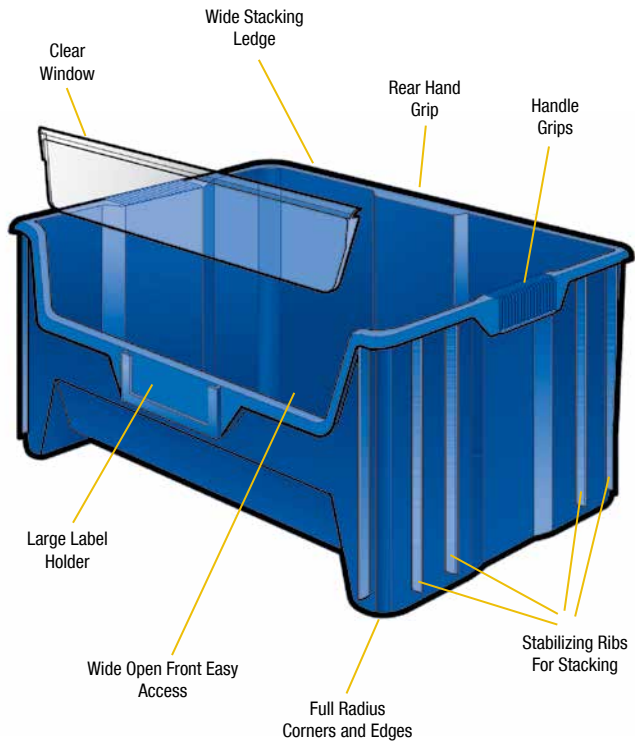

Organize, store, and access your medium or large parts with this high capacity bin center. Up to 400 lb. capacity per shelf and over 21 cubic feet of storage space. Powder coat finish ensures years of dependable use. Easy assembly.

**CLEAR VIEW**

AVAILABLE on pg. 25



**QGH700CL**



**QSBU-700**  
18"D x 42"W x 75"H  
6 shelves and 10 QGH700 bins

**COMPLETE PACKAGES WITH BINS**

**Up to 400 lb.**  
LOAD CAPACITY  
PER SHELF



**QSBU-600**  
18"D x 36"W x 75"H  
6 shelves and 15 QGH600 bins



**QSBU-600800**  
18"D x 36"W x 75"H  
6 shelves, 6 QGH600 bins and 6 QGH800 bins



**QSBU-800**  
18"D x 36"W x 75"H  
6 shelves and 10 QGH800 bins

QGH700 available in: ● Blue ● Ivory ● Red ● Black ● Gray ● Clear

QGH600 and QGH800 available in: ● Blue ● Red ● Gray ● Clear (One color per unit)

**Giant Stack Container Wire Shelving Systems - Complete Packages**



**WR5-600**  
18"W x 36"L x 74"H  
5 shelves and 12 QGH600  
17-1/2"L x 10-7/8"W x 12-1/2"H bins

**COMPLETE PACKAGES WITH BINS**

**CLEAR VIEW**  
AVAILABLE on pg. 25



**WR5-600800**  
18"W x 36"L x 74"H  
5 shelves and 6 QGH600 17-1/2"L x 10-7/8"W x 12-1/2"H bins and 4 QGH800 17-1/2"L x 16-1/2"W x 12-1/2"H bins

**Up to 800 lb. LOAD CAPACITY PER SHELF**



**WR5-800**  
18"W x 36"L x 74"H  
5 shelves and 8 QGH800  
17-1/2"L x 16-1/2"W x 12-1/2"H bins



**MOBILIZE YOUR WIRE SHELVING**

**DB - Donut Bumper**  
Non-marking donut bumper used to protect walls and help cushion impact.

**WR-00H (Mobile Kit)**  
Set of four swivel thermoplastic resin 5" x 1-1/4" casters, two with brakes. Can be used with all units shown. Up to 1,200 lb. load capacity.



**WR5-700**  
18"W x 42"L x 74"H  
5 shelves and 8 QGH700  
15-1/4"L x 19-7/8"W x 12-7/16"H bins

QGH700 available in: ● Blue ● Ivory ● Red ● Black ● Gray ● Clear

QGH600 and QGH800 available in: ● Blue ● Red ● Gray ● Clear (One color per unit)

# 6 SIZES AND 5 COLORS AVAILABLE



## PERFORMANCE FEATURES:

- Available in 6 sizes and 5 colors (Blue, Green, Red, Yellow and Black) for inventory control and color code efficiency
- These heavy-duty containers are injection molded from high density polypropylene and are ideal for storage and transport of large and heavy parts
- Extra heavy, double wall thickness allow containers to stack securely
- Up to 150 lb. stack capacity

## MAGNUM Bins - Super Strong and Durable



Up to **300 lb.**  
MAX CAPACITY  
PER BIN

Heavy-duty, extra strong injection molded, high density polypropylene bins are ideal for transportation and storage of large and heavy parts. Open hopper front allows immediate access and visibility. Ribbed reinforced walls ensure extra strength. Double wall thickness with preformed lip allows bin to interlock and provides up to 150 lb. stack capacity. Transport these bins easily with rear molded handle. Molded in label slot. Impervious to most solvents, corrosion, rust and rot resistant. Resists temperatures from -40°F to 250°F. Optional window front maximizes storage and prevents spillage. Optional dividers maximize flexibility and keeps contents organized.

Available in: ● Blue ● Green ● Red ● Yellow ● Black

MODEL NO.	OUTSIDE DIMENSIONS L" x W" x H"	INSIDE DIMENSIONS L" x W" x H"	X"	CTN QTY	CTN WGT	DIVIDERS	CTN QTY WINDOW	CTN QTY
QMS531	19-3/4" x 12-3/8" x 5-7/8"	17" x 11" x 5"	17"	6	19 lbs	DMS531	6	WMS531
QMS532	19-3/4" x 12-3/8" x 7-7/8"	16-3/4" x 11" x 7-1/4"	16-3/4"	6	23 lbs	DMS532	6	WMS532
QMS533	19-3/4" x 12-3/8" x 11-7/8"	16-5/8" x 10-1/4" x 11-1/8"	16-5/8"	3	15 lbs	DMS533	3	WMS533
QMS543	19-3/4" x 18-3/8" x 11-7/8"	16-5/8" x 16-3/4" x 11"	16-5/8"	1	8 lbs	DMS543	1	WMS543
QMS743*	29" x 18-3/8" x 11-7/8"	25-1/2" x 16-3/4" x 11"	23"	1	10 lbs	-	-	-
QMS843MOB*	29" x 18-3/8" x 14-7/8"	25-1/2" x 16-3/4" x 11"	23"	1	12 lbs	-	-	-

\*Includes heavy-duty spread bar for extra strength and support



LTR-1754  
Clear Label Holder and Insert  
Fits all Magnum bin sizes.  
Package of 25.



COMFORT HANDLE  
for easy gripping and handling

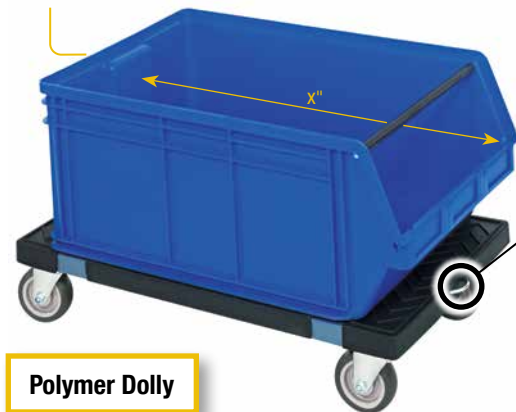

QMS743 and QMS843MOB  
Includes heavy-duty spread bar for extra strength and support



ATTACHED PULL RING  
allows dolly to be pulled with ease

## Polymer Dolly

DLY-3018 is 30"L x 18"W with padded rubber trim, available in Blue. Set of four 4" x 1-1/4" non-marking swivel poly casters. Both dollies have up to 1,000 lb. load capacity.

MODEL NO.	DESCRIPTION	CTN WGT
DLY-3018	Dolly with Padded Rubber Trim	19 lbs
HANDLE-DLY	32" Dolly Pull Rod with Handle	2 lbs

Bins sold separately



CLEAR WINDOW FRONT  
Increases bin capacity and provides a quick view of the bin contents. (Optional)



MAGNUM BIN  
Shown with optional divider

## Mobile MAGNUM Bins

- Bin comes with 4 swivel 3" polyurethane casters, all with brakes, allowing for up to 250 lb. mobile capacity
- Bins can stack on each other with casters in place
- QMS843MOB includes heavy-duty spread bar

**MAGNUM Bin Steel Shelving Systems - Complete Packages**

**Up to 350 lb. LOAD CAPACITY PER SHELF**

These ultra heavy-duty shelving systems incorporate Quantum's Giant MAGNUM Bins. Five combinations allow you a wide selection to choose from. Bins offer optional clear window fronts as well as dividers for maximum storage capacity. Shelving is tough 42" wide with up to 350 lb. load capacity per shelf. Smooth powder coat finish is rust and corrosion resistant.

**COMPLETE PACKAGES WITH BINS**

**MAGNUM**

**18" DEEP UNITS**

18"D x 42"W x 75"H Shelving



**MSU-531**  
 10 shelves and 27 QMS531  
 19-3/4"L x 12-3/8"W x 5-7/8"H bins



**MSU-16-MIX**  
 7 shelves and 4 QMS543  
 19-3/4"L x 18-3/8"W x 11-7/8"H bins,  
 3 QMS533  
 19-3/4"L x 12-3/8"W x 11-7/8"H bins,  
 6 QMS532  
 19-3/4"L x 12-3/8"W x 7-7/8"H bins,  
 3 QMS531  
 19-3/4"L x 12-3/8"W x 5-7/8"H bins

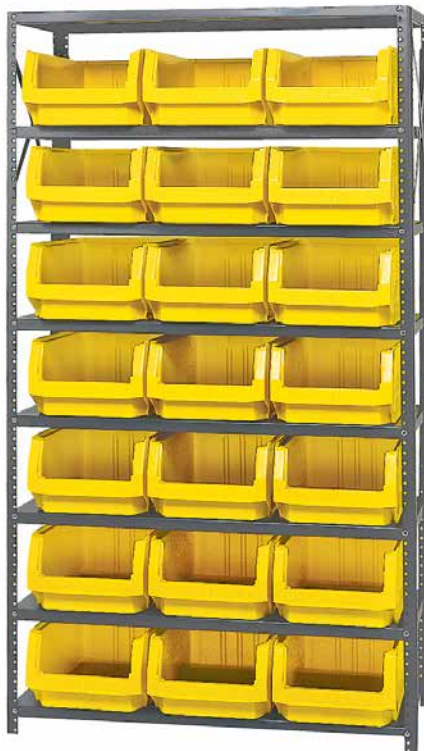

**MSU-532**  
 8 shelves and 21 QMS532  
 19-3/4"L x 12-3/8"W x 7-7/8"H bins



**MSU-533**  
 6 shelves and 15 QMS533  
 19-3/4"L x 12-3/8"W x 11-7/8"H bins



**MSU-543**  
 6 shelves and 10 QMS543  
 19-3/4"L x 18-3/8"W x 11-7/8"H bins

Bins available in: ● Blue ● Green ● Red ● Yellow ● Black (One color per unit)

**MAGNUM Bin Wire Shelving Systems - Complete Packages**



**WR9-531**  
18"W x 42"L x 74"H  
9 shelves and 24 QMS531  
19-3/4"L x 12-3/8"W x 5-7/8"H bins



**WR7-532**  
18"W x 42"L x 74"H  
7 shelves and 18 QMS532  
19-3/4"L x 12-3/8"W x 7-7/8"H bins



**WR5-533**  
18"W x 42"L x 74"H  
5 shelves and 12 QMS533  
19-3/4"L x 12-3/8"W x 11-7/8"H bins



**WR5-543**  
18"W x 42"L x 74"H  
5 shelves and 8 QMS543  
19-3/4"L x 18-3/8"W x 11-7/8"H bins

**Up to 800 lb.**  
LOAD CAPACITY PER SHELF

**MAGNUM**

**COMPLETE  
PACKAGES  
WITH BINS**



**MOBILIZE YOUR WIRE SHELVING**

**DB - Donut Bumper**  
Non-marking donut bumper used to protect walls and help cushion impact.

**WR-00H (Mobile Kit)**  
Set of four swivel thermoplastic resin 5" x 1-1/4" casters, two with brakes. Can be used with all units shown. Up to 1,200 lb. load capacity.



**WR6-13-MIX**  
18"W x 42"L x 74"H  
6 shelves and 4 QMS543 19-3/4"L x 18-3/8"W x 11-7/8"H bins  
3 QMS533 19-3/4"L x 12-3/8"W x 11-7/8"H bins  
3 QMS532 19-3/4"L x 12-3/8"W x 7-7/8"H bins  
3 QMS531 19-3/4"L x 12-3/8"W x 5-7/8"H bins

Bins available in: ● Blue ● Green ● Red ● Yellow ● Black (One color per unit)

**CLEAR VIEW**  
AVAILABLE on pg. 26

# 15 SIZES AND 7 COLORS AVAILABLE



**LOW COST, LONG LASTING, UNBREAKABLE, REUSABLE 4" HIGH BINS**

10° Angle  
45° Angle

**NEW**  
**EVEN WIDER SIZES!**

**QSB122**  
Shown with long and side to side dividers



**LTR-0813**  
**Clear Label Holder and Insert**  
Clear label holders and laser label inserts. Package of 25. Label holders fit all bins (except QSB100).



DLT-6

**Divider Label Tab**

Divider Label Tabs attach to existing dividers enabling sections of bin to be labeled. Tabs improve the visibility of bin labels and scanning of barcodes. Package of 6.

**Extended Label Holders - Simplify Identification**



Optional extended label holders are designed for larger bar code scanning or just larger labels. Label holders fit all Shelf Bins (except QSB100).

MODEL NO.	DESCRIPTION	DIMENSIONS W" x H"	CTN QTY
ELH410	10° Angle	4" x 2-1/4"	24
ELH445	45° Angle	4" x 2-1/4"	24

**Economy 4" Shelf Bins**



Quantum's tough, durable, high density Economy Shelf Bins are the industry standard for quality. These durable polypropylene bins feature a molded-in label holder, built-in rear hanglock which allows bins to tilt out for complete access when on shelving. A wide hopper front allows complete access to the contents of the bin. Edges are reinforced for added strength. They are designed for 12", 18" and 24" deep shelf units, racks or standard shelving. Bins are impervious to most chemicals.

Available in: ● Blue ● Green ● Ivory ● Red ● Yellow ● Black ● Clear

MODEL NO.	OUTSIDE DIMENSIONS L" x W" x H"	INSIDE DIMENSIONS L" x W" x H"	CTN QTY	CTN WGT	DIVIDER	CTN QTY	NO. OF BIN CUPS PER BIN
						QBC111	QBC112
QSB100	11-5/8" x 2-3/4" x 4"	10-1/4" x 1-5/8" x 4"	36	10 lbs	-	-	3
QSB101	11-5/8" x 4-1/8" x 4"	10-1/4" x 3" x 4"	36	13 lbs	DSB101	50	6
QSB102	11-5/8" x 6-5/8" x 4"	10-1/4" x 5-1/2" x 4"	30	15 lbs	DSB102	50	9
QSB107	11-5/8" x 8-3/8" x 4"	10-1/4" x 7-1/8" x 4"	20	12 lbs	DSB107	50	12
QSB109	11-5/8" x 11-1/8" x 4"	10-1/4" x 10" x 4"	8	7 lbs	DSB109	50	18
QSB118 <b>NEW</b>	11-5/8" x 16-1/2" x 4"	10" x 15" x 4"	6	7 lbs	DSB118/122 LDSB118	24 6	27
QSB103	17-7/8" x 4-1/8" x 4"	16-1/2" x 3" x 4"	20	11 lbs	DSB103	50	9
QSB104	17-7/8" x 6-5/8" x 4"	16-1/2" x 5-1/2" x 4"	20	15 lbs	DSB104	50	15
QSB108	17-7/8" x 8-3/8" x 4"	16-1/2" x 7-1/8" x 4"	10	11 lbs	DSB108	50	19
QSB110	17-7/8" x 11-1/8" x 4"	16-1/2" x 10" x 4"	8	10 lbs	DSB110	50	29
QSB122 <b>NEW</b>	17-7/8" x 16-1/2" x 4"	16" x 15" x 4"	6	10 lbs	DSB118/122 LDSB122	24 6	41
QSB105	23-5/8" x 4-1/8" x 4"	22-1/8" x 3" x 4"	16	13 lbs	DSB105	50	13
QSB106	23-5/8" x 6-5/8" x 4"	22-1/8" x 5-1/2" x 4"	8	9 lbs	DSB106	50	21
QSB114	23-5/8" x 8-3/8" x 4"	22-1/8" x 7-1/8" x 4"	6	8 lbs	DSB114	50	24
QSB116	23-5/8" x 11-1/8" x 4"	22-1/8" x 10" x 4"	6	9 lbs	DSB116	50	35

To order a full carton add **CS** suffix to Model No. QSB100BLCS. Note: Bins must be ordered in carton quantities only.

**Dividers and Bin Cups**



Optional dividers fit snugly, horizontally across bins and are uniquely designed to allow for easy part labeling via individual label slots. All bins can accommodate up to 7 dividers.

Bin cups have a raised, slotted label holder for easy parts identification. The entire bin cup may be removed for easy part retrieval. Available in 2 sizes and 2 colors.

Available in: ● Blue ● Yellow

MODEL NO.	OUTSIDE DIMENSIONS L" x W" x H"	CTN QTY	CTN WGT
QBC111	3-1/4" x 1-3/4" x 3"	48	4 lbs
QBC112	5-1/8" x 2-3/4" x 3"	48	7 lbs

**Economy 4" Shelf Bin Steel Shelving Systems  
- Complete Packages**

Economical small parts storage steel systems keep parts easily accessible. Open hopper front bins with label area provide fast access to stored items. This all-in-one unit is easy to clean and will not rust or corrode. Heavy-duty, high grade shelving offers up to 400 lb. capacity per shelf. 36" wide shelving units have a smooth powder coat finish. Bins are available in 7 colors.

Bins available in: ● Blue ● Green ● Ivory ● Red ● Yellow  
● Black ● Clear (One color per unit)

MODEL NO.	NO. OF BINS	BIN DIMENSIONS L" x W" x H"	SHIP WGT
<b>12"D x 36"W x 75"H - 13 Shelf Systems</b>			
1275-100	144 QSB100	11-5/8" x 2-3/4" x 4"	139 lbs
1275-101	96 QSB101	11-5/8" x 4-1/8" x 4"	117 lbs
1275-102	60 QSB102	11-5/8" x 6-5/8" x 4"	115 lbs
1275-107	48 QSB107	11-5/8" x 8-3/8" x 4"	120 lbs
1275-109	36 QSB109	11-5/8" x 11-1/8" x 4"	119 lbs
1275-000	12" Deep Shelving Unit Only - No Bins		87 lbs
<b>12"D x 36"W x 39"H - 7 Shelf Systems</b>			
1239-100	72 QSB100	11-5/8" x 2-3/4" x 4"	75 lbs
1239-101	48 QSB101	11-5/8" x 4-1/8" x 4"	67 lbs
1239-102	30 QSB102	11-5/8" x 6-5/8" x 4"	63 lbs
1239-107	24 QSB107	11-5/8" x 8-3/8" x 4"	64 lbs
1239-109	18 QSB109	11-5/8" x 11-1/8" x 4"	65 lbs
1239-000	12" Deep Shelving Unit Only - No Bins		49 lbs
<b>18"D x 36"W x 75"H - 13 Shelf Systems</b>			
1875-103	96 QSB103	17-7/8" x 4-1/8" x 4"	161 lbs
1875-104	60 QSB104	17-7/8" x 6-5/8" x 4"	155 lbs
1875-108	48 QSB108	17-7/8" x 8-3/8" x 4"	161 lbs
1875-110	36 QSB110	17-7/8" x 11-1/8" x 4"	158 lbs
1875-000	18" Deep Shelving Unit Only - No Bins		113 lbs
<b>18"D x 36"W x 39"H - 7 Shelf Systems</b>			
1839-103	48 QSB103	17-7/8" x 4-1/8" x 4"	87 lbs
1839-104	30 QSB104	17-7/8" x 6-5/8" x 4"	84 lbs
1839-108	24 QSB108	17-7/8" x 8-3/8" x 4"	87 lbs
1839-110	18 QSB110	17-7/8" x 11-1/8" x 4"	86 lbs
1839-000	18" Deep Shelving Unit Only - No Bins		63 lbs



**REAR "V" LOCK**  
enables bins to be hung from shelf above when in use

**ECONOMICAL  
SMALL PARTS  
STORAGE  
SYSTEMS  
KEEP PARTS  
EASILY  
ACCESSIBLE**

1275-102

**COMPLETE PACKAGES  
WITH BINS**



1839-104



AVAILABLE on pg. 27

**COLOR CODE  
PRODUCTS  
TO SIMPLIFY  
ORDER  
PICKING AND  
INVENTORY  
CONTROL**





**Economy 4" Shelf Bin Sloped Shelving Systems - Complete Packages**



Pick Racks provide a convenient high density, easy access, sloped shelving system, available as bench units, single, and double sided free standing and mobile units. Units come complete with Economical 4" Shelf Bins. Sloped shelving unit keeps small and medium sized parts easily accessible. Open hopper front bins with label area, provide fast access to stored items. This all-in-one unit is easy to clean and will not rust or corrode. See chart for configurations. One bin color per unit.



**QPRHA-102**  
Bench Pick Rack  
Up to 250 lb. capacity.

Bins available in: ● Blue ● Green ● Ivory ● Red ● Yellow ● Black ● Clear

MODEL NO.	NO. OF BINS	BIN DIMENSIONS L" x W" x H"	SHIP WGT
<b>12-1/2"L x 36"W x 23"H - 3 Shelf Bench Rack Systems</b>			
QPRHA-100	36 QSB100	11-5/8" x 2-3/4" x 4"	41 lbs
QPRHA-101	24 QSB101	11-5/8" x 4-1/8" x 4"	38 lbs
QPRHA-102	15 QSB102	11-5/8" x 6-5/8" x 4"	36 lbs
QPRHA-107	12 QSB107	11-5/8" x 8-3/8" x 4"	36 lbs
QPRHA-109	9 QSB109	11-5/8" x 11-1/8" x 4"	37 lbs
QPRHA-000	12" Deep Bench Rack Only - No Bins		26 lbs
<b>12"L x 36"W x 60"H - Single Sided 8 Shelf Rack Systems</b>			
QPRS-100	96 QSB100	11-5/8" x 2-3/4" x 4"	99 lbs
QPRS-101	64 QSB101	11-5/8" x 4-1/8" x 4"	85 lbs
QPRS-102	40 QSB102	11-5/8" x 6-5/8" x 4"	80 lbs
QPRS-107	32 QSB107	11-5/8" x 8-3/8" x 4"	81 lbs
QPRS-109	24 QSB109	11-5/8" x 11-1/8" x 4"	83 lbs
QPRS-000	12" Deep Single Sided Rack Only - No Bins		53 lbs
<b>24"L x 36"W x 60"H - Double Sided 16 Shelf Rack Systems</b>			
QPRD-100	192 QSB100	11-5/8" x 2-3/4" x 4"	195 lbs
QPRD-101	128 QSB101	11-5/8" x 4-1/8" x 4"	169 lbs
QPRD-102	80 QSB102	11-5/8" x 6-5/8" x 4"	158 lbs
QPRD-107	64 QSB107	11-5/8" x 8-3/8" x 4"	160 lbs
QPRD-109	48 QSB109	11-5/8" x 11-1/8" x 4"	163 lbs
QPRD-000	24" (12" on each side) Deep Double Sided Rack Only - No Bins		106 lbs
QDU-00*	Mobile Kit - Mobilizes All 24" Double Sided Systems		25 lbs

\*Up to 1,200 lb. load capacity. 2 rigid, 2 swivel with brake hard rubber casters.

**SLOPED SHELVES, EASY ACCESS, MOST POPULAR AND VERSATILE STORAGE SYSTEMS SOLD**

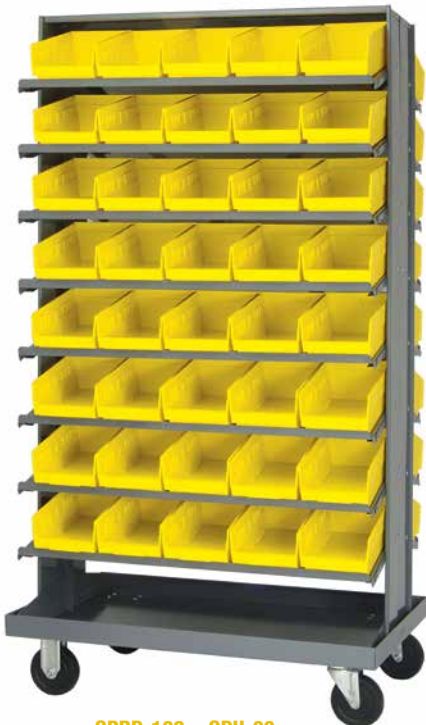

**QPRD-102 + QDU-00**  
Mobile, Double Sided Pick Rack  
Up to 1,200 lb. mobile load capacity. 2 rigid, 2 swivel with brake hard rubber casters.



**QPRD-107**  
Double Sided Pick Rack  
Up to 800 lb. capacity.



**QPRS-101**  
Single Sided Pick Rack  
Up to 400 lb. capacity.



WR12-101

## COMPLETE PACKAGES WITH BINS



AVAILABLE on pg. 26

**Up to 800 lb.**  
LOAD CAPACITY  
PER SHELF



### MOBILIZE YOUR WIRE SHELVING

#### DB - Donut Bumper

Non-marking donut bumper used to protect walls and help cushion impact.

#### WR-00H (Mobile Kit)\*

Set of four swivel thermoplastic resin 5" x 1-1/4" casters, two with brakes. Up to 1,200 lb. load capacity.

\*Mobile kits recommended only for shelves 18" and deeper.

### Economy 4" Shelf Bin Wire Shelving Systems - Complete Packages

Bins available in: ● Blue ● Green ● Ivory ● Red ● Yellow  
● Black ● Clear (One color per unit)

MODEL NO.	NO. OF BINS	BIN DIMENSIONS L" x W" x H"	SHIP WGT
<b>12"W x 36"L x 74"H - 12 Shelf Systems</b>			
WR12-101	88 QSB101	11-5/8" x 4-1/8" x 4"	120 lbs
WR12-102	55 QSB102	11-5/8" x 6-5/8" x 4"	116 lbs
WR12-107	44 QSB107	11-5/8" x 8-3/8" x 4"	117 lbs
WR12-109	33 QSB109	11-5/8" x 11-1/8" x 4"	119 lbs
<b>18"W x 36"L x 74"H - 12 Shelf Systems</b>			
WR12-103	88 QSB103	17-7/8" x 4-1/8" x 4"	176 lbs
WR12-104	55 QSB104	17-7/8" x 6-5/8" x 4"	165 lbs
WR12-108	44 QSB108	17-7/8" x 8-3/8" x 4"	170 lbs
WR12-110	33 QSB110	17-7/8" x 11-1/8" x 4"	168 lbs
<b>24"W x 36"L x 74"H - 12 Shelf Systems</b>			
WR12-105	88 QSB105	23-5/8" x 4-1/8" x 4"	228 lbs
WR12-106	55 QSB106	23-5/8" x 6-5/8" x 4"	218 lbs
WR12-114	44 QSB114	23-5/8" x 8-3/8" x 4"	222 lbs
WR12-116	33 QSB116	23-5/8" x 11-1/8" x 4"	206 lbs

### Economy 4" Complete Bin Center

Complete bin systems are available with 4 different size bin options on a 12"W x 36"L x 36"H unit. This all-purpose bin center is an economical high density storage system that provides easy visibility to stored contents.

- Easy boltless assembly
- Wire allows air to circulate as well as provides ideal product visibility
- Durable chrome finish ensures years of heavy-duty dependability and service

Bins available in: ● Blue ● Green ● Ivory ● Red ● Yellow  
● Black ● Clear (One color per unit)

MODEL NO.	NO. OF BINS	BIN DIMENSIONS L" x W" x H"	SHIP WGT
<b>12"W x 36"L x 36"H - 6 Shelf Systems</b>			
WR6-36-1236-101	40 QSB101	11-5/8" x 4-1/8" x 4"	63 lbs
WR6-36-1236-102	25 QSB102	11-5/8" x 6-5/8" x 4"	50 lbs
WR6-36-1236-107	20 QSB107	11-5/8" x 8-3/8" x 4"	62 lbs
WR6-36-1236-109	15 QSB109	11-5/8" x 11-1/8" x 4"	64 lbs



WR6-36-1236-102



WR12-102



WR12-107

High Density Wire Shelving Systems



- Wire Storage Systems with bins available in 48", 60" and 72" lengths
- All units in chart below utilize 74" posts and include 12 shelves
- Non-marring thermoplastic resin caster kit **WR-00H** (sold separately)



WR74-2448-66106



WR74-2448-66106 + WR-00H + DB (4)  
Shown with optional Mobile Kit



MOBILIZE YOUR WIRE SHELVING

**DB - Donut Bumper**

Non-marking donut bumper used to protect walls and help cushion impact.

**WR-00H (Mobile Kit)\***

Set of four swivel thermoplastic resin 5" x 1-1/4" casters, two with brakes. Up to 1,200 lb. load capacity.

\*Mobile kits recommended only for shelves 18" and deeper.

**Up to 600-800 lb.**  
**LOAD CAPACITY PER SHELF**

Bins available in: ● Blue ● Green ● Ivory ● Red ● Yellow ● Black ● Clear (One color per unit)

HIGH DENSITY WIRE SYSTEMS									
48"L SYSTEMS				60"L SYSTEMS			72"L SYSTEMS		
BIN DIMENSIONS L" x W" x H"	MODEL NO.	NO. OF BINS	SHIP WGT	MODEL NO.	NO. OF BINS	SHIP WGT	MODEL NO.	NO. OF BINS	SHIP WGT
<b>12"W x 48"L - Systems</b>									
11-5/8" x 4-1/8" x 4"	WR74-1248-110101	110 QSB101	152 lbs	<b>12"W x 60"L - Systems</b>			<b>12"W x 72"L - Systems</b>		
11-5/8" x 4-1/8" x 4"		55 QSB101	148 lbs	WR74-1260-143101	143 QSB101	208 lbs	WR74-1272-176101	176 QSB101	248 lbs
11-5/8" x 6-5/8" x 4"	WR74-1248-101102	36 QSB102	140 lbs	WR74-1260-101102	78 QSB101	213 lbs	WR74-1272-101102	80 QSB101	240 lbs
11-5/8" x 6-5/8" x 4"		66 QSB102	140 lbs	WR74-1260-88102	40 QSB102	193 lbs	WR74-1272-110102	60 QSB102	230 lbs
11-5/8" x 6-5/8" x 4"	WR74-1248-66102	66 QSB102	140 lbs		88 QSB102	193 lbs		110 QSB102	230 lbs
<b>18"W x 48"L - Systems</b>									
17-7/8" x 4-1/8" x 4"	WR74-1848-110103	110 QSB103	168 lbs	<b>18"W x 60"L - Systems</b>			<b>18"W x 72"L - Systems</b>		
17-7/8" x 4-1/8" x 4"		55 QSB103	164 lbs	WR74-1860-143103	143 QSB103	224 lbs	WR74-1872-176103	176 QSB103	264 lbs
17-7/8" x 4-1/8" x 4"	WR74-1848-103104	36 QSB104	156 lbs	WR74-1860-103104	78 QSB103	229 lbs	WR74-1872-103104	80 QSB103	256 lbs
17-7/8" x 6-5/8" x 4"	WR74-1848-66104	66 QSB104	156 lbs	WR74-1860-88104	40 QSB104	209 lbs	WR74-1872-110104	60 QSB104	246 lbs
17-7/8" x 6-5/8" x 4"		66 QSB104	156 lbs		88 QSB104	209 lbs		110 QSB104	246 lbs
<b>24"W x 48"L - Systems</b>									
23-5/8" x 4-1/8" x 4"	WR74-2448-110105	110 QSB105	180 lbs	<b>24"W x 60"L - Systems</b>			<b>24"W x 72"L - Systems</b>		
23-5/8" x 4-1/8" x 4"		55 QSB105	176 lbs	WR74-2460-143105	143 QSB105	256 lbs	WR74-2472-176105	176 QSB105	312 lbs
23-5/8" x 6-5/8" x 4"	WR74-2448-105106	36 QSB106	168 lbs	WR74-2460-105106	78 QSB105	261 lbs	WR74-2472-105106	80 QSB105	304 lbs
23-5/8" x 6-5/8" x 4"		66 QSB106	168 lbs	WR74-2460-88106	40 QSB106	241 lbs	WR74-2472-110106	60 QSB106	294 lbs
23-5/8" x 6-5/8" x 4"	WR74-2448-66106	66 QSB106	168 lbs		88 QSB106	241 lbs		110 QSB106	294 lbs

48"L - Up to 800 lb. Capacity/Shelf

60"L - Up to 600 lb. Capacity/Shelf

72"L - Up to 600 lb. Capacity/Shelf

**CLEARVIEW**

AVAILABLE on pg. 28

# 14 SIZES AND 4 COLORS AVAILABLE



## LOW COST, LONG LASTING, UNBREAKABLE, REUSABLE, 6" HIGH SHELF BINS

**QSB222**  
Shown with long and side to side dividers

**QSB218**



**NEW**  
**EVEN WIDER SIZES!**

with **68%** more storage capacity over standard 4" shelf bins, Quantum's **STORE-MORE 6"** Shelf Bins are an industry first and now an industry standard

### STORE-MORE 6" Shelf Bins



Maximize your storage space with durable, high density polypropylene bins. Quantum's STORE-MORE 6" Shelf Bins are the industry standard for quality. These bins feature a molded-in label holder, built-in rear hang-lock which allows bins to tilt out for complete access when on shelving. A wide hopper front allows complete access to the contents of the bin. Edges are reinforced for added strength. They are designed for 12", 18" and 24" deep shelf units, racks or standard shelving. Optional dividers are a perfect accessory to subdivide and keep parts separated as needed. Bins are waterproof and corrosion-free.

Available in: ● Blue ● Red ● Yellow ● Clear

MODEL NO.	OUTSIDE DIMENSIONS L" x W" x H"	INSIDE DIMENSIONS L" x W" x H"	CTN QTY	CTN WGT	DIVIDER	CTN QTY	NO. OF BIN CUPS PER BIN
							QBC111 QBC112
<b>QSB201</b>	11-5/8" x 4-1/8" x 6"	10-1/6" x 3" x 6"	36	19 lbs	<b>DSB201</b>	50	6 2
<b>QSB202</b>	11-5/8" x 6-5/8" x 6"	10-1/6" x 5-1/2" x 6"	30	20 lbs	<b>DSB202</b>	50	9 4
<b>QSB207</b>	11-5/8" x 8-3/8" x 6"	10-1/6" x 7-1/8" x 6"	20	15 lbs	<b>DSB207</b>	50	12 4
<b>QSB209</b>	11-5/8" x 11-1/8" x 6"	10-1/6" x 10" x 6"	8	8 lbs	<b>DSB209</b>	50	18 6
<b>QSB218</b> <b>NEW</b>	11-5/8" x 16-1/2" x 6"	10" x 15" x 6"	6	8 lbs	<b>DSB218/222</b> <b>LDSB218</b>	24 6	27 8
<b>QSB203</b>	17-7/8" x 4-1/8" x 6"	16-1/2" x 3" x 6"	20	18 lbs	<b>DSB203</b>	50	9 3
<b>QSB204</b>	17-7/8" x 6-5/8" x 6"	16-1/2" x 5-1/2" x 6"	20	22 lbs	<b>DSB204</b>	50	15 6
<b>QSB208</b>	17-7/8" x 8-3/8" x 6"	16-1/2" x 7-1/8" x 6"	10	13 lbs	<b>DSB208</b>	50	19 6
<b>QSB210</b>	17-7/8" x 11-1/8" x 6"	16-1/2" x 10" x 6"	8	12 lbs	<b>DSB210</b>	50	29 8
<b>QSB222</b> <b>NEW</b>	17-7/8" x 16-1/2" x 6"	16" x 15" x 6"	6	12 lbs	<b>DSB218/222</b> <b>LDSB222</b>	24 6	41 15
<b>QSB205</b>	23-5/8" x 4-1/8" x 6"	22-1/8" x 3" x 6"	16	19 lbs	<b>DSB205</b>	50	13 4
<b>QSB206</b>	23-5/8" x 6-5/8" x 6"	22-1/8" x 5-1/2" x 6"	8	12 lbs	<b>DSB206</b>	50	21 8
<b>QSB214</b>	23-5/8" x 8-3/8" x 6"	22-1/8" x 7-1/8" x 6"	6	10 lbs	<b>DSB214</b>	50	24 8
<b>QSB216</b>	23-5/8" x 11-1/8" x 6"	22-1/8" x 10" x 6"	6	13 lbs	<b>DSB216</b>	50	35 16

To order a full carton add **CS** suffix to Model No. QSB201**BLCS**. **Note:** Bins must be ordered in carton quantities only.

### Divider Label Tab

Divider Label Tabs attach to existing dividers enabling sections of bin to be labeled. Tabs improve the visibility of bin labels and scanning of barcodes. Package of 6.



**DLT-6**

**LTR-0813**  
**Clear Label Holder and Insert**  
Clear label holders and laser label inserts. Clear label holders fit all 6" Shelf Bins. Package of 25.



### Extended Label Holders - Simplify Identification

Optional extended label holders are designed for larger bar code scanning or just larger labels. Label holders fit all 6" Shelf Bins.

MODEL NO.	DESCRIPTION	DIMENSIONS W" x H"	CTN QTY
<b>ELH410</b>	10° Angle	4" x 2-1/4"	24
<b>ELH445</b>	45° Angle	4" x 2-1/4"	24

10° Angle

45° Angle



### Dividers and Bin Cups

Optional black dividers fit snugly, horizontally across bins to create compartments. Each bin accepts up to 8 dividers. Bins have a slot at the very front allowing the open hopper to be closed off creating even more storage.

Bin cups have a raised, slotted label holder for easy parts identification. The entire bin cup may be removed for easy part retrieval. Available in 2 sizes and 2 colors.

Available in: ● Blue ● Yellow

MODEL NO.	OUTSIDE DIMENSIONS L" x W" x H"	CTN QTY	CTN WGT
<b>QBC111</b>	3-1/4" x 1-3/4" x 3"	48	4 lbs
<b>QBC112</b>	5-1/8" x 2-3/4" x 3"	48	7 lbs

**STORE-MORE 6" Shelf Bin Steel Shelving Systems**  
- Complete Packages

- Economical small parts storage systems keep parts easily accessible
- Open hopper front bins with label area, provide fast access to stored items
- This all-in-one unit is easy to clean and is rust and corrosion resistant
- Heavy-duty, high grade shelving offers up to 400 lb. load capacity per shelf
- 36" wide shelving has a smooth powder coat finish

Bins available in: ● Blue ● Red ● Yellow ● Clear (One color per unit)

MODEL NO.	NO. OF BINS	BIN DIMENSIONS L" x W" x H"	SHIP WGT
<b>12"D x 36"W x 75"H - 10 Shelf Systems</b>			
1275-201	72 QSB201	11-5/8" x 4-1/8" x 6"	111 lbs
1275-202	45 QSB202	11-5/8" x 6-5/8" x 6"	103 lbs
1275-207	36 QSB207	11-5/8" x 8-3/8" x 6"	100 lbs
1275-209	27 QSB209	11-5/8" x 11-1/8" x 6"	98 lbs
<b>12"D x 36"W x 39"H - 5 Shelf Systems</b>			
1239-201	32 QSB201	11-5/8" x 4-1/8" x 6"	56 lbs
1239-202	20 QSB202	11-5/8" x 6-5/8" x 6"	52 lbs
1239-207	16 QSB207	11-5/8" x 8-3/8" x 6"	51 lbs
1239-209	12 QSB209	11-5/8" x 11-1/8" x 6"	50 lbs
<b>18"D x 36"W x 75"H - 10 Shelf Systems</b>			
1875-203	72 QSB203	17-7/8" x 4-1/8" x 6"	156 lbs
1875-204	45 QSB204	17-7/8" x 6-5/8" x 6"	141 lbs
1875-208	36 QSB208	17-7/8" x 8-3/8" x 6"	142 lbs
1875-210	27 QSB210	17-7/8" x 11-1/8" x 6"	139 lbs
<b>18"D x 36"W x 39"H - 5 Shelf Systems</b>			
1839-203	32 QSB203	17-7/8" x 4-1/8" x 6"	77 lbs
1839-204	20 QSB204	17-7/8" x 6-5/8" x 6"	70 lbs
1839-208	16 QSB208	17-7/8" x 8-3/8" x 6"	71 lbs
1839-210	12 QSB210	17-7/8" x 11-1/8" x 6"	69 lbs

**CLEAR VIEW**  
AVAILABLE on pg. 29



1839-208

**COMPLETE PACKAGES WITH BINS**



1275-201



1275-202



1875-210



**LOWEST PRICE GUARANTEE**



AVAILABLE on pg. 29

Bins available in: ● Blue ● Red ● Yellow ● Clear (One color per unit)

MODEL NO.	NO. OF BINS	BIN DIMENSIONS L" x W" x H"	SHIP WGT
<b>12"L x 36"W x 26-1/2"H - 3 Shelf Bench Rack Systems</b>			
QPRHA-201	24 QSB201	11-5/8" x 4-1/8" x 6"	40 lbs
QPRHA-202	15 QSB202	11-5/8" x 6-5/8" x 6"	37 lbs
QPRHA-207	12 QSB207	11-5/8" x 8-3/8" x 6"	36 lbs
QPRHA-209	9 QSB209	11-5/8" x 11-1/8" x 6"	35 lbs
QPRHA-6	12" Deep Bench Rack Only - No Bins		28 lbs
<b>12"L x 36"W x 63-1/2"H - Single Sided 8 Shelf Rack Systems</b>			
QPRS-201	64 QSB201	11-5/8" x 4-1/8" x 6"	89 lbs
QPRS-202	40 QSB202	11-5/8" x 6-5/8" x 6"	81 lbs
QPRS-207	32 QSB207	11-5/8" x 8-3/8" x 6"	79 lbs
QPRS-209	24 QSB209	11-5/8" x 11-1/8" x 6"	77 lbs
QPRS-6	12" Deep Single Sided Rack Only - No Bins		55 lbs
<b>24"L x 36"W x 63-1/2"H - Double Sided 16 Shelf Rack Systems</b>			
QPRD-201	128 QSB201	11-5/8" x 4-1/8" x 6"	178 lbs
QPRD-202	80 QSB202	11-5/8" x 6-5/8" x 6"	162 lbs
QPRD-207	64 QSB207	11-5/8" x 8-3/8" x 6"	158 lbs
QPRD-209	48 QSB209	11-5/8" x 11-1/8" x 6"	154 lbs
QPRD-6	24" (12" on each side) Deep Double Sided Rack Only - No Bins		110 lbs
QDU-00*	Mobile Kit - Mobilizes All 24" Deep Double Sided Units		25 lbs

\*Up to 1,200 lb. load capacity. 2 rigid, 2 swivel with brake hard rubber casters.

**STORE-MORE 6" Shelf Bin Sloped Shelving Systems - Complete Packages**

Pick Racks provide a convenient high density, easy access, sloped shelving system, available as bench units, single, and double sided free standing and mobile units. Units come complete with STORE-MORE 6" Shelf Bins. Sloped shelving unit keeps small and medium sized parts easily accessible. Open hopper front bins with label area, provide fast access to stored items. This all-in-one unit is easy to clean and is rust and corrosion resistant. See chart for configurations.



**QPRHA-209**  
Bench Pick Rack  
Up to 250 lb. capacity.

**SLOPED SHELVES, EASY ACCESS, MOST POPULAR AND VERSATILE STORAGE SYSTEMS SOLD**



**QPRD-202 + QDU-00**  
Mobile, Double Sided Pick Rack  
Up to 1,200 lb. mobile load capacity. 2 rigid, 2 swivel with brake hard rubber casters.



**QPRD-207**  
Double Sided Pick Rack  
Up to 800 lb. capacity.



**QPRS-201**  
Single Sided Pick Rack  
Up to 400 lb. capacity.

**STORE-MORE 6" Shelf Bin Wire Shelving Systems - Complete Packages**

- Easy boltless assembly
- Wire allows air to circulate as well as provides ideal product visibility
- Durable chrome finish ensures years of heavy-duty dependability and service
- All welded shelf construction is supported with super strong wire trusses to provide up to 800 lb. capacity per shelf

Bins available in: ● Blue ● Red ● Yellow ● Clear (One color per unit)

MODEL NO.	NO. OF BINS	BIN DIMENSIONS L" x W" x H"	SHIP WGT
<b>12"W x 36"L x 74"H - 9 Shelf Systems</b>			
WR9-201	64 QSB201	11-5/8" x 4-1/8" x 6"	108 lbs
WR9-202	40 QSB202	11-5/8" x 6-5/8" x 6"	100 lbs
WR9-207	32 QSB207	11-5/8" x 8-3/8" x 6"	98 lbs
WR9-209	24 QSB209	11-5/8" x 11-1/8" x 6"	96 lbs
<b>18"W x 36"L x 74"H - 9 Shelf Systems</b>			
WR9-203	64 QSB203	17-7/8" x 4-1/8" x 6"	156 lbs
WR9-204	40 QSB204	17-7/8" x 6-5/8" x 6"	142 lbs
WR9-208	32 QSB208	17-7/8" x 8-3/8" x 6"	143 lbs
WR9-210	24 QSB210	17-7/8" x 11-1/8" x 6"	140 lbs
<b>24"W x 36"L x 74"H - 9 Shelf Systems</b>			
WR9-205	64 QSB205	23-5/8" x 4-1/8" x 6"	182 lbs
WR9-206	40 QSB206	23-5/8" x 6-5/8" x 6"	171 lbs
WR9-214	32 QSB214	23-5/8" x 8-3/8" x 6"	165 lbs
WR9-216	24 QSB216	23-5/8" x 11-1/8" x 6"	154 lbs

**COMPLETE PACKAGES WITH BINS**



AVAILABLE on pg. 28

**Up to 800 lb. LOAD CAPACITY PER SHELF**



**MOBILIZE YOUR WIRE SHELVING**

**DB - Donut Bumper**  
Non-marking donut bumper used to protect walls and help cushion impact.

**WR-00H (Mobile Kit)\***  
Set of four swivel thermoplastic resin 5" x 1-1/4" casters, two with brakes. Up to 1,200 lb. load capacity.  
*\*Mobile kits recommended only for shelves 18" and deeper.*



WR9-202

**STORE-MORE 6" Complete Bin Center**

Complete bin systems are available with 4 different size bin options on a 12"W x 36"L x 39"H unit. This all-purpose bin center is an economical high density storage system that provides easy visibility to stored contents.

Bins available in: ● Blue ● Red ● Yellow ● Clear (One color per unit)

MODEL NO.	NO. OF BINS	BIN DIMENSIONS L" x W" x H"	SHIP WGT
<b>12"W x 36"L x 36"H - 5 Shelf Systems</b>			
WR5-39-1236-201	32 QSB201	11-5/8" x 4-3/8" x 6"	61 lbs
WR5-39-1236-202	20 QSB202	11-5/8" x 6-5/8" x 6"	57 lbs
WR5-39-1236-207	16 QSB207	11-5/8" x 8-3/8" x 6"	56 lbs
WR5-39-1236-209	12 QSB209	11-5/8" x 11-1/8" x 6"	55 lbs



WR5-39-1236-201



WR9-207



WR9-209

# 12 SIZES AND 4 COLORS AVAILABLE

**CLEAR** BINS  
**VIEW**  
AVAILABLE on pg. 30



**LOW COST, LONG LASTING,  
UNBREAKABLE, REUSABLE,  
8" HIGH BINS**



**LTR-1253**  
**Clear Label Holder and Insert**  
Clear label holders and laser label inserts. Clear label holders fit all 8" Shelf Bins. Package of 25.



**DLT-6**

### Divider Label Tab

Divider Label Tabs attach to existing dividers enabling sections of bin to be labeled. Tabs improve the visibility of bin labels and scanning of barcodes. Package of 6.

### STORE-MAX 8" Shelf Bins



Our 8" high bins offer 95% more storage capacity when compared to the standard 4" high bins and 65% more than the 6" high bins. The new STORE-MAX 8" Bins will truly maximize and organize your space. Manufactured from high density polypropylene, STORE-MAX 8" Shelf Bins are the industry standard for quality. These bins feature a molded-in label holder, built-in rear hang-lock which allows bins to tilt out for complete access when on shelving. A wide hopper front allows complete access to the contents of the bin. Edges are reinforced for added strength. They are designed for 12", 18" and 24" deep shelf units, racks, or standard shelving. Optional dividers are a perfect accessory to subdivide and keep parts separated as needed. See **pg. 30** to order Clear Bins.



### Dividers and Bin Cups

Optional black dividers fit snugly, horizontally across bins to create compartments. Each bin accepts up to 7 dividers.

Bin cups have a raised, slotted label holder for easy parts identification. The entire bin cup may be removed for easy part retrieval. Available in 2 sizes and 2 colors.

Available in: ● Blue ● Yellow

MODEL NO.	OUTSIDE DIMENSIONS L" x W" x H"	CTN QTY	CTN WGT
<b>QBC111</b>	3-1/4" x 1-3/4" x 3"	48	4 lbs
<b>QBC112</b>	5-1/8" x 2-3/4" x 3"	48	7 lbs

Available in: ● Blue ● Red ● Yellow ● Clear

MODEL NO.	OUTSIDE DIMENSIONS L" x W" x H"	INSIDE DIMENSIONS L" x W" x H"	CTN QTY	CTN WGT	DIVIDER	CTN QTY	NO. OF BIN CUPS PER BIN
<b>QSB801</b>	11-5/8" x 4-1/8" x 8"	10-1/6" x 3" x 8"	36	27 lbs	<b>DSB801</b>	50	6 2
<b>QSB802</b>	11-5/8" x 6-5/8" x 8"	10-1/6" x 5-1/2" x 8"	30	26 lbs	<b>DSB802</b>	50	9 4
<b>QSB807</b>	11-5/8" x 8-3/8" x 8"	10-1/6" x 7-1/8" x 8"	20	21 lbs	<b>DSB807</b>	50	12 4
<b>QSB809</b>	11-5/8" x 11-1/8" x 8"	10-1/6" x 10" x 8"	8	11 lbs	<b>DSB809</b>	50	18 6
<b>QSB803</b>	17-7/8" x 4-1/8" x 8"	16-1/2" x 3" x 8"	20	22 lbs	<b>DSB803</b>	50	9 3
<b>QSB804</b>	17-7/8" x 6-5/8" x 8"	16-1/2" x 5-1/2" x 8"	20	26 lbs	<b>DSB804</b>	50	15 6
<b>QSB808</b>	17-7/8" x 8-3/8" x 8"	16-1/2" x 7-1/8" x 8"	10	15 lbs	<b>DSB808</b>	50	19 6
<b>QSB810</b>	17-7/8" x 11-1/8" x 8"	16-1/2" x 10" x 8"	8	17 lbs	<b>DSB810</b>	50	29 8
<b>QSB805</b>	23-5/8" x 4-1/8" x 8"	22-1/8" x 3" x 8"	16	24 lbs	<b>DSB805</b>	50	13 4
<b>QSB806</b>	23-5/8" x 6-5/8" x 8"	22-1/8" x 5-1/2" x 8"	8	13 lbs	<b>DSB806</b>	50	21 8
<b>QSB814</b>	23-5/8" x 8-3/8" x 8"	22-1/8" x 7-1/8" x 8"	6	12 lbs	<b>DSB814</b>	50	24 8
<b>QSB816</b>	23-5/8" x 11-1/8" x 8"	22-1/8" x 10" x 8"	6	14 lbs	<b>DSB816</b>	50	35 16

**STORE-MAX 8" Shelf Bin Steel Shelving Systems - Complete Packages**

- Economical small parts storage systems keep parts easily accessible
- Open hopper front bins with label area, provide fast access to stored items
- This all-in-one unit is easy to clean and is rust and corrosion resistant
- Heavy-duty, high grade shelving offers up to 400 lb. load capacity per shelf
- 36" wide shelving has a smooth powder coat finish

Bins available in: ● Blue ● Red ● Yellow ● Clear *(One color per unit)*

MODEL NO.	NO. OF BINS	BIN DIMENSIONS L" x W" x H"	SHIP WGT
<b>12"D x 36"W x 75"H - 8 Shelf Systems</b>			
1275-SB801	56 QSB801	11-5/8" x 4-3/8" x 8"	111 lbs
1275-SB802	35 QSB802	11-5/8" x 6-5/8" x 8"	103 lbs
1275-SB807	28 QSB807	11-5/8" x 8-3/8" x 8"	100 lbs
1275-SB809	21 QSB809	11-5/8" x 11-1/8" x 8"	98 lbs
<b>12"D x 36"W x 39"H - 4 Shelf Systems</b>			
1239-SB801	24 QSB801	11-5/8" x 4-3/8" x 8"	56 lbs
1239-SB802	15 QSB802	11-5/8" x 6-5/8" x 8"	52 lbs
1239-SB807	12 QSB807	11-5/8" x 8-3/8" x 8"	51 lbs
1239-SB809	9 QSB809	11-5/8" x 11-1/8" x 8"	50 lbs
<b>18"D x 36"W x 75"H - 8 Shelf Systems</b>			
1875-SB803	56 QSB803	17-7/8" x 4-3/8" x 8"	156 lbs
1875-SB804	35 QSB804	17-7/8" x 6-5/8" x 8"	141 lbs
1875-SB808	28 QSB808	17-7/8" x 8-3/8" x 8"	142 lbs
1875-SB810	21 QSB810	17-7/8" x 11-1/8" x 8"	139 lbs
<b>18"D x 36"W x 39"H - 4 Shelf Systems</b>			
1839-SB803	24 QSB803	17-7/8" x 4-3/8" x 8"	77 lbs
1839-SB804	15 QSB804	17-7/8" x 6-5/8" x 8"	70 lbs
1839-SB808	12 QSB808	17-7/8" x 8-3/8" x 8"	71 lbs
1839-SB810	9 QSB810	17-7/8" x 11-1/8" x 8"	69 lbs

**COMPLETE PACKAGES WITH BINS**



AVAILABLE on pg. 31



1275-SB801

**Up to 400 lb.**  
LOAD CAPACITY  
PER SHELF



1239-SB807



1275-SB802



1275-SB809



WR8-801

## COMPLETE PACKAGES WITH BINS



AVAILABLE on pg. 31

**Up to 800 lb.**  
LOAD CAPACITY  
PER SHELF



### MOBILIZE YOUR WIRE SHELVING

#### DB - Donut Bumper

Non-marking donut bumper used to protect walls and help cushion impact.

#### WR-00H (Mobile Kit)\*

Set of four swivel thermoplastic resin 5" x 1-1/4" casters, two with brakes. Up to 1,200 lb. load capacity.

\*Mobile kits recommended only for shelves 18" and deeper.



WR8-802



WR8-809

### STORE-MAX 8" Shelf Bin Wire Shelving Systems - Complete Packages

- Easy boltless assembly
- Wire allows air to circulate as well as provides ideal product visibility
- Durable chrome finish ensures years of heavy-duty dependability and service
- All welded shelf construction is supported with super strong wire trusses to provide up to 800 lb. load capacity per shelf

Bins available in: ● Blue ● Red ● Yellow ● Clear (One color per unit)

MODEL NO.	NO. OF BINS	BIN DIMENSIONS L" x W" x H"	SHIP WGT
<b>12"W x 36"L x 74"H - 8 Shelf Systems</b>			
WR8-801	49 QSB801	11-5/8" x 4-3/8" x 8"	100 lbs
WR8-802	35 QSB802	11-5/8" x 6-5/8" x 8"	103 lbs
WR8-807	28 QSB807	11-5/8" x 8-3/8" x 8"	102 lbs
WR8-809	21 QSB809	11-5/8" x 11-1/8" x 8"	101 lbs
<b>18"W x 36"L x 74"H - 8 Shelf Systems</b>			
WR8-803	49 QSB803	17-7/8" x 4-3/8" x 8"	150 lbs
WR8-804	35 QSB804	17-7/8" x 6-5/8" x 8"	142 lbs
WR8-808	28 QSB808	17-7/8" x 8-3/8" x 8"	138 lbs
WR8-810	21 QSB810	17-7/8" x 11-1/8" x 8"	141 lbs
<b>24"W x 36"L x 74"H - 8 Shelf Systems</b>			
WR8-805	49 QSB805	23-5/8" x 4-3/8" x 8"	194 lbs
WR8-806	35 QSB806	23-5/8" x 6-5/8" x 8"	177 lbs
WR8-814	28 QSB814	23-5/8" x 8-3/8" x 8"	176 lbs
WR8-816	21 QSB816	23-5/8" x 11-1/8" x 8"	169 lbs

### STORE-MAX 8" Complete Bin Center

Complete bin systems are available with 4 different size bin options on a 12"W x 36"L x 39"H unit. This all-purpose bin center is an economical high density storage system that provides easy visibility to stored contents.

Bins available in: ● Blue ● Red ● Yellow ● Clear (One color per unit)

MODEL NO.	NO. OF BINS	BIN DIMENSIONS L" x W" x H"	SHIP WGT
<b>12"W x 36"L x 39"H - 4 Shelf Systems</b>			
WR4-39-1236-801	21 QSB801	11-5/8" x 4-3/8" x 8"	80 lbs
WR4-39-1236-802	15 QSB802	11-5/8" x 6-5/8" x 8"	78 lbs
WR4-39-1236-807	12 QSB807	11-5/8" x 8-3/8" x 8"	77 lbs
WR4-39-1236-809	9 QSB809	11-5/8" x 11-1/8" x 8"	77 lbs



WR4-39-1236-807

Super Tuff Euro Drawers



# 9 SIZES AND 4 COLORS AVAILABLE

Super Tuff Euro Drawers are available in nine sizes and four colors and are designed for efficient organization of heavy parts, supplies, tools or equipment. Super Tuff Euro Drawers are injection molded from virgin grade high impact polystyrene and are virtually unbreakable. These heavy-duty drawers can be used on Quantum's open and closed shelf units and pick racks.

Available in: ● Blue ● Red ● Yellow ● Gray

MODEL NO.	OUTSIDE DIMENSIONS L" x W" x H"*	INSIDE DIMENSIONS L" x W" x H"	CTN QTY	CTN WGT	NUMBER OF DIVIDER SLOTS	DIVIDER	DIV CTN QTY
QED401	11-5/8" x 5-9/16" x 2-1/8"	10-1/4" x 5-1/8" x 2"	24	17 lbs	8	DIV401	4
QED501	11-5/8" x 3-3/4" x 4-5/8"	10-1/4" x 3-1/4" x 4-3/8"	24	19 lbs	8	DIV501/604	4
QED601	11-7/8" x 5-9/16" x 4-5/8"	10-3/4" x 5-1/8" x 4-3/8"	24	24 lbs	8	DIV6123	4
QED701	11-5/8" x 8-3/8" x 4-5/8"	10-1/4" x 7-3/4" x 4-3/8"	24	31 lbs	8	DIV701/606	4
QED801	11-5/8" x 11-1/8" x 4-5/8"	10-1/4" x 10-5/8" x 4-3/8"	12	19 lbs	8	DIV801	4
QED604	17-5/8" x 3-3/4" x 4-5/8"	16-1/2" x 3-1/4" x 4-1/4"	24	29 lbs	15	DIV501/604	4
QED602	17-3/4" x 5-9/16" x 4-5/8"	16-1/2" x 5-1/8" x 4-3/8"	24	32 lbs	13	DIV6123	4
QED606	17-5/8" x 8-3/8" x 4-5/8"	16-1/4" x 7-7/8" x 4-3/8"	24	46 lbs	13	DIV701/606	4
QED603	24" x 5-9/16" x 4-5/8"	22-5/8" x 5-1/8" x 4-3/8"	12	25 lbs	18	DIV6123	4

\*Rear tab adds an additional 3/8" to rear height

## PERFORMANCE FEATURES:

- Available in 9 sizes
- Bins are injection molded from a virgin grade high impact polystyrene and are virtually unbreakable
- Drawers are completely waterproof
- Drawers are oil and chemical resistant
- Smooth front curved pull handle has ample room for adhesive labels or bar codes
- Front handle has 3/4" opening for convenient easy gripping
- Full width back ledge ensures spill free use
- Optional dividers are full height for subdividing bins and prevents mixing of parts
- Available in four colors ideal for color coding inventory: Blue, Yellow, Red and Gray

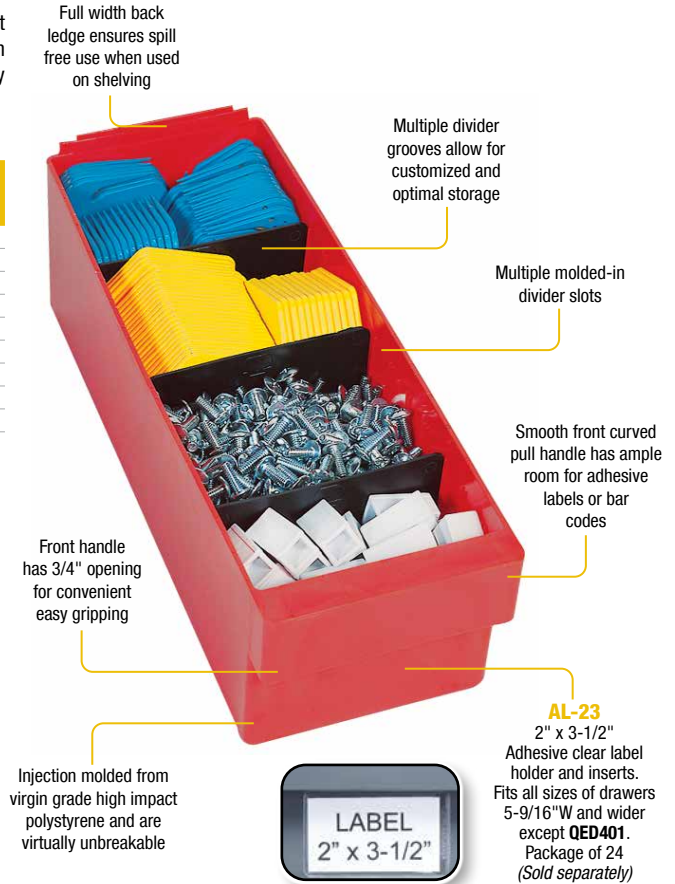

### 12" Deep Euro Drawers

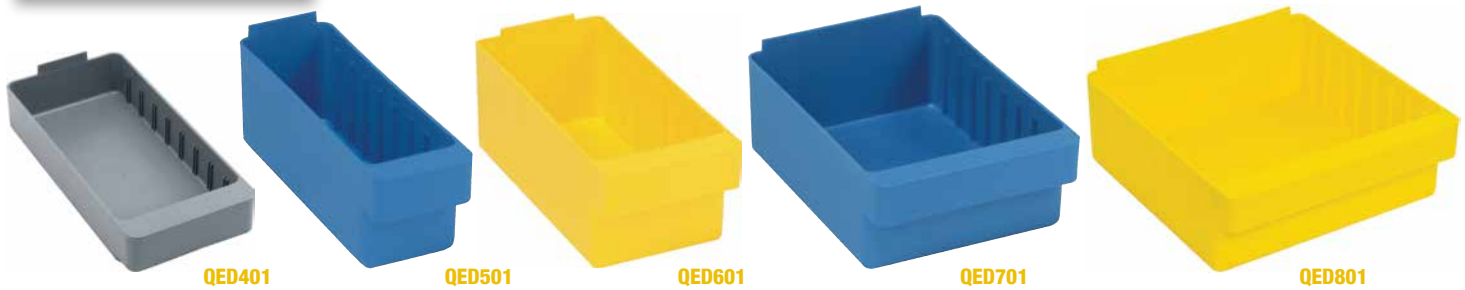

### 18" Deep Euro Drawers



### 24" Deep Euro Drawer



## HEAVY-DUTY DRAWERS VIRTUALLY UNBREAKABLE



**CL1875-624**  
Closed Unit  
(Complete with side and back panels)

**Closed and Open Shelving Systems with Super Tuff Drawers - Complete Packages**

Save time locating parts using our tough Euro Drawers with our sturdy open or closed steel shelving. 36" wide x 75" or 39" high units offer heavy-duty, high grade shelving with up to 400 lb. load capacity per shelf. Closed shelving provides a dust free environment for stored parts.



**1239-601**  
Open Unit  
(No side or back panels)

Drawers available in: ● Blue ● Yellow ● Red ● Gray (One color per unit)

CLOSED UNITS		OPEN UNITS		BIN DIMENSIONS L" x W" x H"	NO. OF BINS	SHIP WGT
MODEL NO.	MODEL NO.	MODEL NO.	MODEL NO.			
<b>12"D x 36"W x 75"H - 13 Shelf Systems</b>						
CL1275-401*	1275-401*	1275-401*	1275-401*	11-5/8" x 5-9/16" x 2-1/8"	108 QED401	231 lbs
CL1275-501	1275-501	1275-501	1275-501	11-5/8" x 3-3/4" x 4-5/8"	108 QED501	215 lbs
CL1275-601	1275-601	1275-601	1275-601	11-5/8" x 5-9/16" x 4-5/8"	72 QED601	192 lbs
CL1275-701	1275-701	1275-701	1275-701	11-5/8" x 8-3/8" x 4-5/8"	48 QED701	171 lbs
CL1275-801	1275-801	1275-801	1275-801	11-5/8" x 11-1/8" x 4-5/8"	36 QED801	189 lbs
CL1275-000	1275-000	1275-000	1275-000	12" Deep Steel Unit Only - No Bins		129 lbs
<b>18"D x 36"W x 75"H - 13 Shelf Systems</b>						
CL1875-602	1875-602	1875-602	1875-602	17-7/8" x 5-9/16" x 4-5/8"	72 QED602	266 lbs
CL1875-604	1875-604	1875-604	1875-604	17-7/8" x 3-3/4" x 4-5/8"	108 QED604	287 lbs
CL1875-624	1875-624	1875-624	1875-624	17-7/8" x 5-9/16" x 4-5/8"	36 QED602	276 lbs
CL1875-606	1875-606	1875-606	1875-606	17-7/8" x 3-3/4" x 4-5/8"	54 QED604	276 lbs
CL1875-606	1875-606	1875-606	1875-606	17-7/8" x 8-3/8" x 4-5/8"	48 QED606	237 lbs
CL1875-000	1875-000	1875-000	1875-000	18" Deep Steel Unit Only - No Bins		167 lbs
<b>24"D x 36"W x 75"H - 13 Shelf Systems</b>						
CL2475-603	2475-603	2475-603	2475-603	23-7/8" x 5-9/16" x 4-5/8"	72 QED603	360 lbs
<b>12"D x 36"W x 39"H - 7 Shelf Systems</b>						
CL1239-401**	1239-401**	1239-401**	1239-401**	11-5/8" x 5-9/16" x 2-1/8"	54 QED401	121 lbs
CL1239-601	1239-601	1239-601	1239-601	11-5/8" x 5-9/16" x 4-5/8"	36 QED601	99 lbs
CL1239-000	1239-000	1239-000	1239-000	12" Deep Steel Unit Only - No Bins		70 lbs
<b>18"D x 36"W x 39"H - 7 Shelf Systems</b>						
CL1839-602	1839-602	1839-602	1839-602	17-7/8" x 5-9/16" x 4-5/8"	36 QED602	139 lbs
CL1839-604	1839-604	1839-604	1839-604	17-7/8" x 3-3/4" x 4-5/8"	54 QED604	155 lbs
CL1839-624	1839-624	1839-624	1839-624	17-7/8" x 5-9/16" x 4-5/8"	18 QED602	147 lbs
CL1839-000	1839-000	1839-000	1839-000	3-3/4" x 4-5/8"	27 QED604	147 lbs
CL1839-000	1839-000	1839-000	1839-000	18" Deep Steel Unit Only - No Bins		89 lbs
<b>24"D x 36"W x 39"H - 7 Shelf Systems</b>						
CL2439-603	2439-603	2439-603	2439-603	23-7/8" x 5-9/16" x 4-5/8"	36 QED603	198 lbs

\*Unit includes 19 shelves \*\*Unit includes 10 shelves

**COMPLETE PACKAGES WITH BINS**

**Up to 400 lb.**  
LOAD CAPACITY  
PER SHELF

**HIGH DENSITY, HEAVY-DUTY,  
DUST FREE AND SECURE STORAGE**

**MORE ECONOMICAL  
SOLUTION COMPARED TO  
HIGHER COST STEEL  
DRAWER UNITS**

**Euro Drawer Sloped Shelving Systems - Complete Packages**

**COMPLETE PACKAGES WITH BINS**

Sturdy steel racks with Super Tuff Euro Drawers create an efficient flow system. Sloped shelving provides easy access to stored items. Drawers can be removed from racks easily. These gray colored baked enamel, free standing racks assemble easily. Mobile unit has up to 1,200 lb. load capacity and is equipped with 2 swivel, 2 rigid casters. One drawer color per system.



**QPRHA-601**  
Bench Pick Rack  
Up to 250 lb. capacity.

Drawers available in: ● Blue ● Yellow ● Red ● Gray

(One color per unit)

MODEL NO.	NO. OF BINS	BIN DIMENSIONS L" x W" x H"	SHIP WGT
<b>12-1/2"L x 36"W x 23"H - 3 Shelf Bench Rack Systems</b>			
<b>QPRHA-501</b>	27 QED501	11-5/8" x 3-3/4" x 4-5/8"	48 lbs
<b>QPRHA-601</b>	18 QED601	11-5/8" x 5-9/16" x 4-5/8"	42 lbs
<b>QPRHA-701</b>	12 QED701	11-5/8" x 8-3/8" x 4-5/8"	42 lbs
<b>QPRHA-567</b>	9 QED501 6 QED601 4 QED701	11-5/8" x 3-3/4" x 4-5/8" 11-5/8" x 5-9/16" x 4-5/8" 11-5/8" x 8-3/8" x 4-5/8"	44 lbs
<b>QPRHA-000</b>	12-1/2" Deep Bench Rack Only - No Bins		26 lbs
<b>12"L x 36"W x 60"H - Single Sided 8 Shelf Rack Systems</b>			
<b>QPRS-501</b>	72 QED501	11-5/8" x 3-3/4" x 4-5/8"	110 lbs
<b>QPRS-601</b>	48 QED601	11-5/8" x 5-9/16" x 4-5/8"	91 lbs
<b>QPRS-701</b>	32 QED701	11-5/8" x 8-3/8" x 4-5/8"	95 lbs
<b>QPRS-801</b>	24 QED801	11-5/8" x 11-1/8" x 4-5/8"	93 lbs
<b>QPRS-5678</b>	18 QED501 12 QED601 8 QED701 6 QED801	11-5/8" x 3-3/4" x 4-5/8" 11-5/8" x 5-9/16" x 4-5/8" 11-5/8" x 8-3/8" x 4-5/8" 11-5/8" x 11-1/8" x 4-5/8"	99 lbs
<b>QPRS-000</b>	12" Deep Single Sided Rack Only - No Bins		53 lbs
<b>24"L x 36"W x 60"H - Double Sided 16 Shelf Rack Systems</b>			
<b>QPRD-501</b>	144 QED501	11-5/8" x 3-3/4" x 4-5/8"	220 lbs
<b>QPRD-601</b>	96 QED601	11-5/8" x 5-9/16" x 4-5/8"	190 lbs
<b>QPRD-701</b>	64 QED701	11-5/8" x 8-3/8" x 4-5/8"	189 lbs
<b>QPRD-801</b>	48 QED801	11-5/8" x 11-1/8" x 4-5/8"	186 lbs
<b>QPRD-5678</b>	36 QED501 24 QED601 16 QED701 12 QED801	11-5/8" x 3-3/4" x 4-5/8" 11-5/8" x 5-9/16" x 4-5/8" 11-5/8" x 8-3/8" x 4-5/8" 11-5/8" x 11-1/8" x 4-5/8"	197 lbs
<b>QPRD-000</b>	24" (12" on each side) Deep Double Sided Rack Only - No Bins		106 lbs
<b>QDU-00*</b>	Mobile Kit - Mobilizes All 24" Deep Double Sided Units		25 lbs

\*Up to 1,200 lb. load capacity. 2 rigid, 2 swivel with brake hard rubber casters.

**SLOPED SHELVES, EASY ACCESS, MOST POPULAR AND VERSATILE STORAGE SYSTEMS SOLD**



**QPRS-601**  
Single Sided Pick Rack  
Up to 400 lb. capacity.

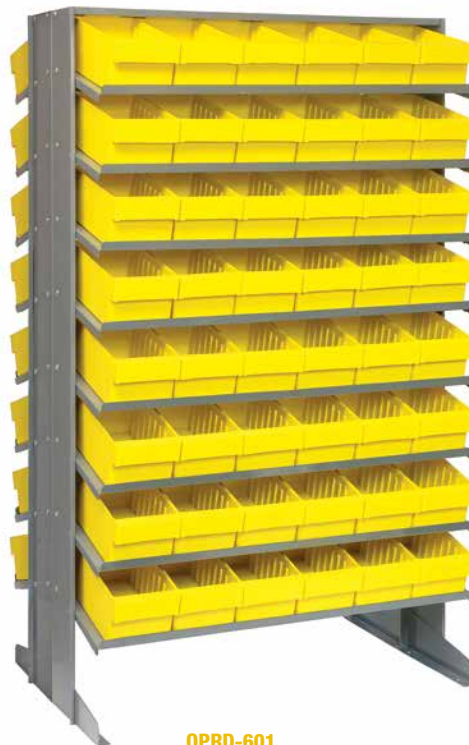

**QPRD-601**  
Double Sided Pick Rack  
Up to 800 lb. capacity.



**QPRD-601 + QDU-00**  
Mobile, Double Sided Pick Rack  
Up to 1,200 lb. mobile load capacity. 2 rigid, 2 swivel with brake hard rubber casters.



Double reinforced sides add strength and prevent bins from spreading when stacked

**STACK 'EM**

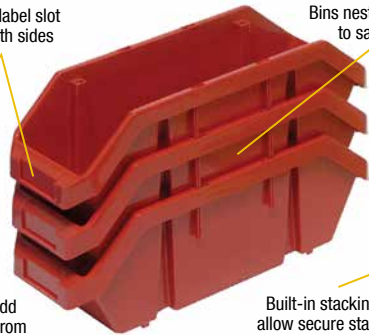

Large label slot on both sides

Bins nest when empty to save space

**NEST 'EM**



Built-in stacking ledges allow secure stacking and cross stacking

**CROSS STACK 'EM**

Create up to 4 Compartments



**QP1265**  
Shown with optional Dividers **CD1265/LD1265**

QuickPick Bin



**6 SIZES AND 3 COLORS AVAILABLE**

**Dividers**

These heavy-duty, polypropylene storage bins provide an open hopper front and back, allowing double sided access to stored parts. Bins stack one on top of the other, both vertically and cross-wise, and nest when empty for space efficiency. Optional dividers may be used front to back, side to side, or both at the same time, dividing the bin into four sections. A molded in label holder on both the front and back of the bin allows for easy parts identification. Bins can be used on standard metal or wire shelving as well as on desks, bench tops or work stations.

Available in: ● Blue ● Red ● Yellow

MODEL NO.	OUTSIDE DIMENSIONS L" x W" x H"	INSIDE DIMENSIONS L" x W" x H"	X**	CTN QTY	CTN WGT	CROSS DIVIDER	CTN QTY	LENGTH DIVIDER	CTN QTY	CLEAR LABEL HOLDER & INSERT
QP965	9-1/2" x 6-5/8" x 5"	8-1/2" x 4-3/4" x 4-3/4"	6"	20	15 lbs	CD965	10	LD965	10	LTR-1253
QP1265	12-1/2" x 6-5/8" x 5"	11-1/2" x 4-3/4" x 4-3/4"	9"	20	19 lbs	CD1265	10	LD1265	10	LTR-1253
QP1285	12-1/2" x 8-3/8" x 5"	11-1/2" x 6-1/2" x 4-3/4"	9"	20	22 lbs	CD1285	10	LD1285	10	LTR-1253
QP1496	14" x 9-1/4" x 6-1/2"	13" x 7" x 6-1/4"	8-1/8"	20	26 lbs	CD1496	10	LD1496	10	LTR-1253
QP1867	18-1/2" x 6-5/8" x 7"	16-7/8" x 4-3/4" x 6-3/4"	13-1/8"	10	16 lbs	CD1867	10	LD1867	10	LTR-1253
QP1887	18-1/2" x 8-3/8" x 7"	16-3/4" x 6-1/2" x 6-3/4"	13-1/8"	10	18 lbs	CD1887	10	LD1887	10	LTR-1253

\*X" dimensions is inside flat bottom length

**LTR-1253 Clear Label Holder & Insert**  
Clear label holders and laser label inserts. Fits all QuickPick Bins. Package of 25.

Optional dividers may be used front to back, side to side or both at the same time, dividing the bin into four sections.



**THE MOST VERSATILE BIN IN THE INDUSTRY WITH DOUBLE SIDED ACCESS**

**Heavy-Duty Wire Shelving with QuickPick Bins - Complete Packages**

These unique shelving packages provide double sided access to stored parts. QuickPick Bins allow two users to access stored product at the same time. This ergonomic, space efficient work station is the ultimate space saver. Shelving systems measure 18"W x 36"L x 74"H and may be ordered with or without a mobile kit. These heavy-duty systems offer up to 800 lb. capacity per shelf. Optional dividers may be used front to back, side to side or both at the same time, dividing the bin into four sections. A molded in label holder on both the front and back of the bin allows for easy part identification.

Bins available in: ● Blue ● Red ● Yellow (One color per unit)

MODEL NO.	NO. OF BINS	DIMENSIONS L" x W" x H"	SHIP WGT
<b>W7-12-30</b>	30 QP1265	12-1/2" x 6-5/8" x 5"	110 lbs
<b>W7-12-26</b>	10 QP1265	12-1/2" x 6-5/8" x 5"	107 lbs
	16 QP1285	12-1/2" x 8-3/8" x 5"	
<b>W7-12-28</b>	20 QP1265	12-1/2" x 6-5/8" x 5"	109 lbs
	8 QP1285	12-1/2" x 8-3/8" x 5"	
<b>W7-12-24</b>	24 QP1285	12-1/2" x 8-3/8" x 5"	106 lbs
<b>W7-14-18</b>	18 QP1496	14" x 9-1/4" x 6-1/2"	105 lbs
<b>W7-18-30</b>	30 QP1867	18-1/2" x 6-5/8" x 7"	128 lbs
<b>W7-18-26</b>	10 QP1867	18-1/2" x 6-5/8" x 7"	125 lbs
	16 QP1887	18-1/2" x 8-3/8" x 7"	
<b>W7-18-28</b>	20 QP1867	18-1/2" x 6-5/8" x 7"	127 lbs
	8 QP1887	18-1/2" x 8-3/8" x 7"	
<b>W7-18-24</b>	24 QP1887	18-1/2" x 8-3/8" x 7"	124 lbs

**Mobile Kit**

**WR-00H\*** Mobilizes Wire Shelving Unit 14 lbs

\*Set of four swivel thermoplastic resin 5" x 1-1/4" casters, two with brakes. Up to 1,200 lb. load capacity. Mobile kits recommended only for shelves 18" and deeper.

**Up to 800 lb. LOAD CAPACITY PER SHELF**



W7-12-26



WRC3-1836-1867

**QuickPick Bin Mobile Wire Cart**

Carts are available in a 2 or 3 shelf configuration complete with four casters (all swivel, two with brakes). Overall dimensions: 18"W x 36"L x 37-1/2"H. Mobile cart is easy to assemble. One color per cart.

Bins available in: ● Blue ● Red ● Yellow (One color per unit)

MODEL NO.	NO. OF BINS	DIMENSIONS L" x W" x H"	CTN WGT
<b>WRC2-1836-1265</b>	10 QP1265	12-1/2" x 6-5/8" x 5"	49 lbs
<b>WRC3-1836-1265</b>	15 QP1265	12-1/2" x 6-5/8" x 5"	64 lbs
<b>WRC2-1836-1285</b>	8 QP1285	12-1/2" x 8-3/8" x 5"	48 lbs
<b>WRC3-1836-1285</b>	12 QP1285	12-1/2" x 8-3/8" x 5"	63 lbs
<b>WRC2-1836-1867</b>	10 QP1867	18-1/2" x 6-5/8" x 7"	55 lbs
<b>WRC3-1836-1867</b>	15 QP1867	18-1/2" x 6-5/8" x 7"	73 lbs
<b>WRC2-1836-1887</b>	8 QP1887	18-1/2" x 8-3/8" x 7"	54 lbs
<b>WRC3-1836-1887</b>	12 QP1887	18-1/2" x 8-3/8" x 7"	72 lbs

Smooth Wall Storage Boxes



Quantum's Smooth Wall Storage Boxes are built to optimize storage space. Made from heavy-duty polypropylene, these boxes are lightweight, durable, and break resistant. Precision engineering and design ensures a space-efficient and secure stacked configuration. The boxes withstand temperatures ranging from -40°F to 160°F. **Colors:** White and Gray. Custom colors are also available, please call for details.



**FSB-PT26183**  
 Shown with LID **FSB-PL2618**



**FSB-DL1813 (LID)**



**FSB-DT18133**



**FSB-PL2618 (LID)**



**FSB-PT26183**



**FSB-PT26186**

**IDEAL FOR STORING AND TRANSPORTING INDUSTRIAL AND HEAVY-DUTY PARTS**

**Up to 800 lb. MOBILE LOAD CAPACITY**

Unit consists of:

- 6 - Box Lid - **FSB-DL1813**
- 6 - Box - **FSB-DT18133**
- 6 - Box - **FSB-PT26183**
- 6 - Box Lid - **FSB-PL2618**
- 1 - Dolly - **FSB-PTDLY**



**FSB-PTDLY**  
 25-5/8" L X 18" W X 7" H  
 Includes four 5" x 1-1/4" poly casters, two rigid, two swivel, one with brake. Available in Black.



**FSB-MD3LP3L**

**ADD SUFFIX TO END OF EACH MODEL NO. WHEN SELECTING COLOR**

• WHITE WT • GRAY GY

- Freezer and Microwaveable safe

MODEL NO.	OUTSIDE DIMENSIONS L" x W" x H"	INSIDE DIMENSIONS L" x W" x H"	CAP CU FT	CTN QTY	CTN WGT
<b>FSB-PT26183</b>	25-5/8" x 18" x 3-3/8"	23-7/8" x 16" x 3"	0.66	6	25 lbs
<b>FSB-PT26186</b>	25-5/8" x 18" x 6-3/8"	23-7/8" x 16" x 6"	1.33	6	31 lbs
<b>FSB-PL2618</b>	25-5/8" x 18" x 1-3/4"	23-7/8" x 16" x 1"	0.22	6	16 lbs
<b>FSB-DT18133</b>	17-3/4" x 12-3/4" x 3-3/8"	15-7/8" x 11-1/8" x 3"	0.31	6	11 lbs
<b>FSB-DL1813</b>	17-3/4" x 12-3/4" x 3/4"	15-7/8" x 11-1/8" x 3/4"	0.08	6	6 lbs

To order a full case add **CS** suffix to Model No. **FSB-PT26183GYCS**



All Purpose Tubs & Utility Bins



Quantum's heavy-duty all-purpose nesting tubs and utility boxes are built to last! Manufactured from Polypropylene, these containers are engineered for rigorous and continuous usage. All tubs are super easy to clean and dishwasher safe. Virgin grade materials afford lifetime protection against bacteria, mold, mildew, and product degradation. **Colors:** Black, Brown or Gray. Custom colors are also available, please call for details.

**3 COLORS AVAILABLE**  
**BUILT TO LAST!**



**FSB-21155**



**FSB-21155R**  
(Ribbed bottom)



**FSB-22175**



**FSB-22177R**  
"AIRPORT SECURITY BIN"  
(Ribbed bottom) Available in Blue(BL)



**NEST WHEN EMPTY TO SAVE SPACE**

• Bulk, no carton packaging available, call for details

MODEL NO.	OUTSIDE DIMENSIONS L" x W" x H"	INSIDE DIMENSIONS L" x W" x H"	CAP CU FT	CTN QTY	CTN WGT	LID MODEL NO.
<b>FSB-1295</b>	12-1/16" x 9-1/16" x 5-1/8"	11-1/4" x 8-1/4" x 5"	0.325	12	11 lbs	-
<b>FSB-1544</b>	14-3/16" x 4-7/16" x 4-1/8"	13-1/2" x 16" x 4"	0.150	12	5 lbs	-
<b>FSB-20113</b>	20-7/16" x 11-3/8" x 3-3/4"	19-7/8" x 16" x 3-5/8"	0.496	12	20 lbs	-
<b>FSB-20155</b>	20" x 15" x 5"	19-1/4" x 14-1/4" x 4-7/8"	0.868	12	20 lbs	<b>FSB-L2016</b>
<b>FSB-20155R*</b>	20" x 15" x 5"	19-1/4" x 14-1/4" x 4-7/8"	0.868	12	19 lbs	<b>FSB-L2216</b>
<b>FSB-21155</b>	21" x 15" x 5"	20-1/4" x 14-1/4" x 4-7/8"	0.911	12	24 lbs	<b>FSB-L2115</b>
<b>FSB-21155R</b>	21" x 15" x 5"	20-1/4" x 14-1/4" x 4-7/8"	0.911	12	26 lbs	<b>FSB-L2115R</b>
<b>FSB-21157</b>	21" x 15" x 7"	20-1/4" x 14-1/4" x 6-7/8"	1.276	12	26 lbs	<b>FSB-L2115</b>
<b>FSB-21157R</b>	21" x 15" x 7"	20-1/4" x 14-1/4" x 6-7/8"	1.276	12	27 lbs	<b>FSB-L2115R</b>
<b>FSB-21165</b>	20" x 15" x 5"	19-1/2" x 14-1/4" x 4-7/8"	0.868	12	32 lbs	-
<b>FSB-22175</b>	22" x 17" x 5"	21-1/4" x 16-1/4" x 4-7/8"	1.082	12	27 lbs	<b>FSB-L2217</b>
<b>FSB-22177R*</b>	21-1/2" x 17" x 7"	21-1/4" x 16-1/4" x 6-7/8"	1.057	12	32 lbs	-

To order a full carton add **CS** suffix to Model No. FSB-20155BKCS. \*Available in Blue as a fourth standard color.  
**Note:** Bins must be ordered in carton quantities only.



**FSB-1295**



**FSB-1544**



**FSB-20113**



**FSB-21165**



**FSB-20155**



**FSB-20155R**  
"AIRPORT SECURITY BIN"  
(Ribbed bottom) Also available in Blue(BL)



**FSB-21157**



**FSB-21157R**  
(Ribbed bottom)

All-purpose tubs provide a storage, cleaning, and transportation solution for multiple applications. Built in handles are ergonomically designed for comfortable and easy-grip and handling. All tubs nest when empty saving valuable workspace.

**ADD SUFFIX TO END OF EACH MODEL NO. WHEN SELECTING COLOR**

• GRAY GY • BROWN BN • BLACK BK • BLUE BL **Ex. FSB-20155BK**

**SUPER EASY TO CLEAN**



**Latch Containers & Wire Shelving System - Complete Packages**



Quantum's new Latch Containers feature heavy-duty latches on each end that snap lock providing a tight and secure fit. Once latch is engaged parts inside are fully protected from dirt or getting wet. These durable and ultra-strong containers can hold up to 75 lbs. Injection molded from durable, high impact polypropylene. Lids feature reinforced ribs that allow totes to safely and securely stack on top of each other.

Available in: ● Black ● Clear

MODEL NO.	OUTSIDE DIMENSIONS L" x W" x H"	INSIDE TOP DIMENSIONS L" x W" x H"	INSIDE BOTTOM DIMENSIONS L" x W"	CAP GAL	CTN QTY	CTN WGT	LID	CTN QTY
LC191507	21" x 15-7/8" x 7-3/4"	18-3/8" x 14-5/8" x 7-1/4"	15-7/8" x 12-7/8"	7.03	6	12 lbs	LID1915	6
LC191507CL	21" x 15-7/8" x 7-3/4"	18-3/8" x 14-5/8" x 7-1/4"	15-7/8" x 12-7/8"	7.03	6	12 lbs	LID1915CL	6



LC191507CL and LID1915CL



LID1915 and LID1915CL Latch Container Lid

**CONTAINERS HOLD Up to 75 lbs.**



LC191507 and LID1915



LC191507CL Containers Nesting



LC191507CL and LID1915CL Containers Stacked with Lid



WR6-191507CL 21"W x 36"L x 74"H 6 shelves with 12 LC191507CL and 12 LID1915CL



WR6-191507 21"W x 36"L x 74"H 6 shelves with 12 LC191507 and 12 LID1915



**MOBILIZE YOUR WIRE SHELVING**

**DB - Donut Bumper**  
Non-marking donut bumper used to protect walls and help cushion impact.

**WR-00H (Mobile Kit)\***  
Set of four swivel thermoplastic resin 5" x 1-1/4" casters, two with brakes. Can be used with all units shown. Up to 1,200 lb. load capacity. \*Mobile kits recommended only for shelves 18" and deeper.

# 11 SIZES AND 4 COLORS AVAILABLE



### DIVIDERS

Containers can be divided by length and/or width allowing a subdivision down to a 1-1/8" square compartment size. Available in Gray.



### SNAP ON COVERS

Snap on covers protect contents from damage or dust during shipping and storage.



### CLEAR LABEL HOLDER

Fits any size container. Three sizes to choose from. Attach via Velcro fastening.



AVAILABLE on pg. 33



### DG92060

Shown with optional Clear Dust Cover Acrylic Inlay

## Clear Dust Cover Acrylic Inlays

Clear Acrylic Dust Cover Inlays keep stored items visible while protecting against airborne dust and other contaminants. Cover lays inside on recessed rim of container.

MODEL NO.	FITS BIN MODEL NO.	CTN QTY
<b>DDC91000CL</b>	DG91025, DG91035, DG91050	10
<b>DDC92000CL</b>	DG92035, DG92050, DG92060, DG92080	4
<b>DDC93000CL</b>	DG93030, DG93060, DG93080, DG93120	3



### DG92060 and DG93060

Shown with optional Dividers and Clear Covers



## Dividable Grid Containers



Shown with optional Clear Label Holder



Heavy-duty Dividable Grid Containers can be used in industrial, commercial, electronic and health care industries for storage, assembly, fabrication and distribution applications. These containers offer the safest and most efficient method for compartmentalizing and protecting small to medium sized parts. Dividers allow you to customize the container's interior to meet your exact needs. Containers and covers are available in 4 colors.

Available in: ● Blue ● Gray ● Red ● Clear

MODEL NO.	OUTSIDE DIMENSIONS L" x W" x H"	INSIDE DIMENSIONS L" x W" x H"	CTN QTY	CTN WGT	SHORT DIVIDER	CTN LONG DIVIDER	CTN QTY COVER	CTN QTY
<b>Number of Dividers on Short Side: 5 / Long Side: 7</b>								
<b>DG91025</b>	10-7/8" x 8-1/4" x 2-1/2"	9-3/16" x 6-9/16" x 2"	20	16 lbs	<b>DS91025</b>	6 <b>DL91025</b>	6 <b>COV91000</b>	10
<b>DG91035</b>	10-7/8" x 8-1/4" x 3-1/2"	9-3/16" x 6-9/16" x 3"	20	24 lbs	<b>DS91035</b>	6 <b>DL91035</b>	6 <b>COV91000</b>	10
<b>DG91050</b>	10-7/8" x 8-1/4" x 5"	9-3/16" x 6-9/16" x 4-1/2"	20	32 lbs	<b>DS91050</b>	6 <b>DL91050</b>	6 <b>COV91000</b>	10
<b>Number of Dividers on Short Side: 7 / Long Side: 11</b>								
<b>DG92035</b>	16-1/2" x 10-7/8" x 3-1/2"	14-7/8" x 9-1/4" x 3"	12	23 lbs	<b>DS92035</b>	6 <b>DL92035</b>	6 <b>COV92000</b>	4
<b>DG92050</b>	16-1/2" x 10-7/8" x 5"	14-7/8" x 9-1/4" x 4-1/2"	12	25 lbs	<b>DS92050</b>	6 <b>DL92050</b>	6 <b>COV92000</b>	4
<b>DG92060</b>	16-1/2" x 10-7/8" x 6"	14-7/8" x 9-1/4" x 5-1/2"	8	20 lbs	<b>DS92060</b>	6 <b>DL92060</b>	6 <b>COV92000</b>	4
<b>DG92080</b>	16-1/2" x 10-7/8" x 8"	14-7/8" x 9-1/4" x 7-1/2"	8	27 lbs	<b>DS92080</b>	6 <b>DL92080</b>	6 <b>COV92000</b>	4
<b>Number of Dividers on Short Side: 11 / Long Side: 15</b>								
<b>DG93030</b>	22-1/2" x 17-1/2" x 3"	20-5/8" x 15-5/8" x 2-1/2"	6	20 lbs	<b>DS93030</b>	6 <b>DL93030</b>	6 <b>COV93000</b>	3
<b>DG93060</b>	22-1/2" x 17-1/2" x 6"	20-5/8" x 15-5/8" x 5-1/2"	3	16 lbs	<b>DS93060</b>	6 <b>DL93060</b>	6 <b>COV93000</b>	3
<b>DG93080</b>	22-1/2" x 17-1/2" x 8"	20-5/8" x 15-5/8" x 7-1/2"	3	19 lbs	<b>DS93080</b>	6 <b>DL93080</b>	6 <b>COV93000</b>	3
<b>DG93120</b>	22-1/2" x 17-1/2" x 12"	20-5/8" x 15-5/8" x 11-1/2"	3	23 lbs	<b>DS93120</b>	6 <b>DL93120</b>	6 <b>COV93000</b>	3

## Clear Label Holders

MODEL NO.	DIMENSIONS H" x W"	FITS BIN MODEL NO.	CTN QTY
<b>LBL2X8</b>	2" x 8"	DG91025, DG91035, DG92035, DG93030	6
<b>LBL3X5</b>	3" x 5"	DG91050, DG92050, DG92060, DG93060	6
<b>LBL5X8</b>	5" x 8"	DG92080, DG93080, DG93120	6

## Clear Covers

MODEL NO.	FITS BIN MODEL NO.	CTN QTY
<b>COV91000CL</b>	DG91025, DG91035, DG91050	10
<b>COV92000CL</b>	DG92035, DG92050, DG92060, DG92080	4
<b>COV93000CL</b>	DG93030, DG93060, DG93080, DG93120	3



AVAILABLE on pg. 32

# 9 SIZES AND 4 COLORS AVAILABLE



snh010

All nine sizes of totes have ability to use our optional 3" x 5" clear label holder. It securely attaches to tote with or without lid for easy part identification.



AL-35

3" x 5" Clear Adhesive Label Holder and Inserts attaches securely to container for easy part identification. Package of 24.



Optional lid snaps on tightly and securely to protect container contents. As pictured, lids can be fastened and locked for added security.

## Genuine stack and nest totes



These heavy-duty, tough, and dependable stack and nest totes are the ultimate reusable container for storing and transporting your valuable items in any application. These proven containers are available in nine sizes and four colors for efficiency and inventory control.

Available in: ● Blue ● Gray ● Red ● Clear

MODEL NO.	OUTSIDE DIMENSIONS L" x W" x H"	A	B	INSIDE DIMENSIONS			CAP CU FT	CAP GAL	CTN QTY	CTN WGT	LID	CTN QTY
				C	D	E						
snt180	18" x 11" x 6"	10"	16"	15-1/4"	9-3/8"	5-7/8"	0.50	3.70	6	12 lbs	LID181	6
snt185	18" x 11" x 9"	10"	16"	15-1/8"	9-1/8"	8-7/8"	0.76	5.69	6	15 lbs	LID181	6
snt190	19-1/2" x 15-1/2" x 10"	14-1/2"	17"	16"	13-1/4"	9-7/8"	1.20	9.00	6	23 lbs	LID191	6
snt195	19-1/2" x 15-1/2" x 13"	14-1/2"	17"	15-7/8"	13-3/8"	12-7/8"	1.70	12.93	6	26 lbs	LID191	6
snt200	19-1/2" x 13-1/2" x 8"	12-3/8"	17-7/8"	16-3/8"	11-1/2"	7-7/8"	0.80	6.10	6	19 lbs	LID201	6
snt225	23-1/2" x 19-1/2" x 10"	18-1/4"	20-7/8"	19-3/8"	16-7/8"	9-7/8"	2.00	14.98	3	18 lbs	LID231	3
snt230	23-1/2" x 19-1/2" x 13"	18-1/8"	20-7/8"	19-1/2"	16-7/8"	12-7/8"	2.60	19.40	3	22 lbs	LID231	3
snt240	23-1/2" x 15-1/2" x 12"	14-1/4"	20-7/8"	19-5/8"	13"	11-7/8"	1.70	12.90	3	18 lbs	LID241	3
snt300	29-1/2" x 19-1/2" x 15"	18-1/4"	26-5/8"	25-1/8"	16-5/8"	14-7/8"	3.70	27.40	3	31 lbs	LID301	3
snh010	Clear Label Holder - 3" x 5" (Fits all tote sizes)								6	1 lb	-	-

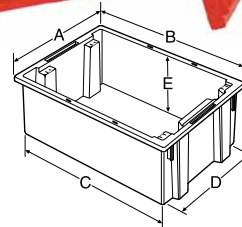

Bin Inside Dimensions Guide  
A (top width) B (top length) E (height)  
C (bottom length) D (bottom width)

## stack and nest totes PERFORMANCE FEATURES:

- Available in 9 sizes
- Standard colors: Blue, Gray, Red and Clear
- Totes are injection molded from high-density polypropylene material and are manufactured from FDA and USDA approved materials
- stack and nest totes will not corrode, bend out of shape, are unaffected by chemicals and are waterproof
- Reusable container will stack with or without lids for maximum storage and shipping
- snt's have the unique ability to stack or they can be turned 180° to nest when empty saving valuable space
- Optional lids for totes can be secured with nylon ties
- Textured bottoms ensure safe and easy, non-slip grip in transit on conveyors

## LIGHTWEIGHT, HEAVY-DUTY HDPE SIMPLE SNAP-TOGETHER DESIGN

Up to 500-2,700 lb. LOAD CAPACITY

### Polymer Dunnage Rack

MODEL NO.	DIMENSIONS W" x L" x H"	SHIP WGT
<b>Ventilated Top</b>		
362412DPP	24" x 36" x 12"	13 lbs
363612DPP	36" x 36" x 12"	22 lbs
482412DPP	24" x 48" x 12"	19 lbs
662412DPP	24" x 66" x 12"	23 lbs
663612DPP	36" x 66" x 12"	37 lbs
962412DPP	24" x 96" x 12"	34 lbs
963612DPP	36" x 96" x 12"	53 lbs
<b>Solid Top</b>		
362412DPS	24" x 36" x 12"	17 lbs
363612DPS	36" x 36" x 12"	26 lbs
482412DPS	24" x 48" x 12"	21 lbs
662412DPS	24" x 66" x 12"	28 lbs
663612DPS	36" x 66" x 12"	49 lbs
962412DPS	24" x 96" x 12"	41 lbs
963612DPS	36" x 96" x 12"	64 lbs



For more detailed info See pg. 159



Polymer Dunnage Rack



**Chrome Wire Shelving System with Genuine stack and nest totes**

Offering up to 600-800 lb. load capacity per shelf, this chrome wire shelving system with totes is a must have for archival storage, heavy-duty parts organization or inventory control applications. With three packages to choose from offering three colors choices for the bins, this system can be used just about anywhere. System may be made mobile with the addition of the **WR-00H** mobile kit. See *pg. 70* for additional information and to order optional accessories.

**Up to 600-800 lb. LOAD CAPACITY PER SHELF**

MODEL NO.	NO. OF SHELVES	NO. OF BINS	BIN DIMENSIONS L" x W" x H"	SHIP WGT
<b>18"W x 48"L x 74"H - Wire Shelving Systems with stack and nest totes - Totes are available in Gray, Blue, Red and Clear</b>				
WR9-36180	9	36 snt180	18" x 11" x 6"	178 lbs
WR6-24185	6	24 snt185	18" x 11" x 9"	136 lbs
<b>24"W x 66"L x 63"H - Wire Shelving System with stack and nest totes - Totes are available in Gray, Blue, Red and Clear</b>				
WR4-12225	4	12 snt225	23-1/2" x 19-1/2" x 10"	170 lbs



AVAILABLE on *pg. 32*

**WR9-36180**  
Shown with optional lid and label holders (Sold separately)



**MOBILIZE YOUR WIRE SHELVING**

**DB - Donut Bumper**  
Non-marking donut bumper used to protect walls and help cushion impact.

**WR-00H (Mobile Kit)**  
Set of four swivel thermoplastic resin 5" x 1-1/4" casters, two with brakes. Can be used with all units shown. Up to 1,200 lb. load capacity.

**Chrome Mobile Wire Shelving Systems with Cross Stack Tubs & Quantub Nesting Tote**

These unique packages provide a storage solution for large, bulky items. These heavy-duty tubs provide easy access to stored parts for assembly areas, picking stations or inventory control. With three packages to choose from, these strong durable totes provide a durable solution for most applications. See *pg. 72* for more information.

MODEL NO.	NO. OF SHELVES	NO. OF BINS	BIN DIMENSIONS L" x W" x H"	SHIP WGT
<b>24"W x 60"L x 69"H - Mobile, Wire Shelving System with QuanTub Totes - Totes are available in Gray and Blue</b>				
MWR4-2419-9	4	12 TUB2419-9	24-1/2" x 19" x 9-1/2"	175 lbs
<b>18"W x 36"L x 69"H - Mobile, Wire Shelving System with Cross Stack Tubs - Tubs are available in Gray, Blue and White</b>				
MWR7-1711-8	7	24 TUB1711-8	17-1/4" x 11" x 8"	151 lbs
MWR5-1711-12	5	15 TUB1711-12	17-1/4" x 11" x 12"	118 lbs



**MWR4-2419-9**  
These heavy-duty tubs provide easy access to stored parts for assembly areas

**COMPLETE PACKAGES WITH BINS**

**WR7-92080**  
Allow for multiple compartment configurations within each bin



**Chrome Wire Shelving System with Dividable Grid Containers**

Same durable chrome wire shelving combined with Quantum's Dividable Grid Containers. These containers allow for multiple compartment configurations within each bin. Offering four different packages, these systems are ideal for small and medium parts storage. System may be made mobile with the addition of the **WR-00H** mobile kit. See *pg. 69* for additional container information and to order optional container accessories.

**Up to 600-800 lb. LOAD CAPACITY PER SHELF**

MODEL NO.	NO. OF SHELVES	NO. OF BINS	BIN DIMENSIONS L" x W" x H"	SHIP WGT
<b>18"W x 48"L x 74"H - Wire Shelving Systems with Dividable Grid Containers - Containers are available in Gray, Blue, Red and Clear</b>				
WR9-92060	9	36 DG92060	16-1/2" x 10-7/8" x 6"	210 lbs
WR7-92080	7	24 DG92080	16-1/2" x 10-7/8" x 8"	174 lbs
<b>24"W x 60"L x 63"H - Wire Shelving System with Dividable Grid Containers - Containers are available in Gray, Blue, Red and Clear</b>				
WR12-93030	12	36 DG93030	22-1/2" x 17-1/2" x 3"	274 lbs
WR9-93060	9	24 DG93060	22-1/2" x 17-1/2" x 6"	254 lbs



AVAILABLE on *pg. 33*

Cross Stack Tub



# 5 SIZES AND 5 COLORS AVAILABLE

Manufactured from approved USDA/FDA materials, totes nest when empty or can be turned 90° to cross stack. Easy access to items when stacked. Injection molded from durable, high impact polypropylene. Easy to clean. Built in handle grips and bottom grooves makes handling easy. Holds up to 100 lbs. per bin 1/4" drill hole pattern on bottom of bin allows for easy hole insertion for optional drainage and air flow.

Available in: ● Blue ● Gray ○ White **TUB2516-8/LID2516-8** also available in: ● Red ● Yellow

MODEL NO.	OUTSIDE DIMENSIONS L" x W" x H"	INSIDE BOTTOM DIMENSIONS L" x W"	CAP GAL	CTN QTY	CTN WGT LID	CTN QTY
TUB1711-8	17-1/4" x 11" x 8"	13" x 7-1/2"	3.85	6	14 lbs	LID1711 6
TUB1711-12	17-1/4" x 11" x 12"	12-5/8" x 7"	5.51	6	17 lbs	LID1711 6
TUB2417-8	23-3/4" x 17-1/4" x 8"	19-5/8" x 13-3/4"	9.81	6	25 lbs	LID2417 6
TUB2417-12	23-3/4" x 17-1/4" x 12"	18-7/8" x 13-1/4"	14.38	6	30 lbs	LID2417 6
TUB2516-8	25-1/8" x 16" x 8-1/2"	20-1/2" x 13-3/8"	9.75	6	20 lbs	LID2516-8 6
SNH010	Six Clear Label Holders - 3" x 5"		6	1 lb	-	-



**TUB2516-8**  
Nesting and Cross Stack



**LID2516-8**

Optional lid keeps stored items dust free. Tubs can still stack or cross stack with lids in place.

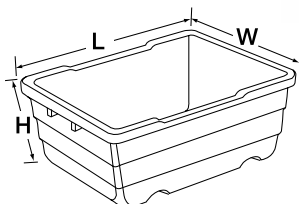

**Bin Dimensions Guide**  
L (length) W (width) H (height)

QuanTub Nesting Tote



Manufactured of approved USDA/FDA materials, this tote is ideal in food service and storage and general product handling. Strong and durable tote is injection molded from high-density polypropylene. Each tote can hold up to 100 lbs. Tote is easy to clean. Rolled top rim for comfortable grip. Rounded corners add strength to stress points. Totes nest when empty and prevent jamming with rib top. 1/4" drill hole pattern on bottom of bin allows for easy hole insertion for optional air flow and drainage.

Available in: ● Blue ● Gray

MODEL NO.	OUTSIDE DIMENSIONS L" x W" x H"	INSIDE BOTTOM DIMENSIONS A" x B"	CAP GAL	CTN QTY	CTN WGT
TUB2419-9	24-1/2" x 19" x 9-1/2"	20-1/4" x 15-1/4"	14.6	6	33 lbs



**TUB2419-9**  
Nesting

Polymer Dolly

DLY-3018 is 30"L x 18"W with padded rubber trim, available in Blue. Set of four 4" x 1-1/4" non-marking swivel poly casters. Up to 1,000 lb. load capacity.

MODEL NO.	DESCRIPTION	CTN WGT
DLY-3018	Dolly with Padded Rubber Trim	19 lbs
HANDLE-DLY	32" Dolly Pull Rod with Handle	2 lbs



**ATTACHED PULL RING**  
allows dolly to be pulled with ease



6-1/2" overall height

**HANDLE-DLY**  
Dolly Pull Rod

**Tub Racks - Complete Packages**

All-welded aluminum Tub Rack transports and stores all types of product. Cart comes with four swivel 5" x 1" Polyolefin casters. Runners allow bins to slide in and out from both sides. Rack comes complete with tubs.

Tubs available in: ● Blue ● Gray ○ White ● Red ● Yellow

MODEL NO.	RACK DIMENSIONS L" x W" x H"	NO. OF BINS	SHIP WGT
<b>Tub Rack with Cross Stack Tubs</b>			
<b>Tub Dimensions 25-1/8"L x 16"W x 8-1/2"H</b>			
TR1-2516-8	27" x 16-3/4" x 19"	1	13 lbs
TR2-2516-8	29-1/4" x 19" x 33"	2	25 lbs
TR3-2516-8	27" x 19" x 41"	3	33 lbs
TR4-2516-8	27" x 19" x 51"	4	46 lbs
TR5-2516-8	27" x 19" x 61"	5	54 lbs
TR6-2516-8	27" x 19" x 71"	6	58 lbs
TR12-2516-8	27" x 37" x 71"	12	114 lbs



**TR12-2516-8**  
Comes with 12 TUB2516-8

**EACH BIN LEVEL WILL SUPPORT**  
**Up to 60 lbs.**  
*(One Tub extended at a time)*

**Up to 400 lb.**  
**MOBILE LOAD CAPACITY**

**COMPLETE PACKAGES WITH BINS**



**TR1-2516-8**  
Comes with 1 TUB2516-8

**TR2-2516-8**  
Comes with 2 TUB2516-8

**TR3-2516-8**  
Comes with 3 TUB2516-8

**TR4-2516-8**  
Comes with 4 TUB2516-8

**TR5-2516-8**  
Comes with 5 TUB2516-8

**TR6-2516-8**  
Comes with 6 TUB2516-8

**Stackers - Heavy-Duty Straight Wall Stacking Container**

Heavy-duty, straight wall containers maximize your space when used for shipping, storage or work-in progress. Greater strength and durability provided by reinforced corners allowing this strong container to hold the heaviest of parts. Containers are injection molded from high-density polyethylene. Straight wall design allows for modular stacking of all sizes on standard pallets. Hand grips on two sides make the container easy to handle and carry. Up to 175 lb. stack capacity.

Available in: ● Gray

MODEL NO.	OUTSIDE DIMENSIONS L" x W" x H"	INSIDE DIMENSIONS L" x W" x H"	CTN QTY	VOLUME CU FT	SHIP WGT	LID
<b>RS01207-5</b>	12" x 7-3/8" x 5"	9-1/2" x 5-3/4" x 4-3/4"	1	0.10	2 lbs	-
<b>RS01215-5</b>	12" x 15" x 5"	9-3/8" x 13-3/8" x 4-7/8"	1	0.30	2 lbs	<b>LID1215</b>
<b>RS01215-7</b>	12" x 15" x 7-7/16"	9-3/8" x 13-3/8" x 7"	1	0.50	3 lbs	<b>LID1215</b>
<b>RS02415-5</b>	24" x 15" x 5"	21-1/2" x 13" x 4-7/8"	1	0.70	4 lbs	<b>LID2415</b>
<b>RS02415-7</b>	24" x 15" x 7-1/2"	21-1/2" x 13" x 7"	1	1.10	5 lbs	<b>LID2415</b>
<b>RS02415-9</b>	24" x 15" x 9-1/2"	21-1/2" x 13" x 9"	1	1.40	5 lbs	<b>LID2415</b>
<b>RS02422-11*</b>	24" x 22-1/2" x 10-7/8"	21-1/2" x 20-1/2" x 10-5/8"	1	3.50	8 lbs	-

\*Cannot be used on **DLY-2415**. Use with **DLY-3018** Dolly.

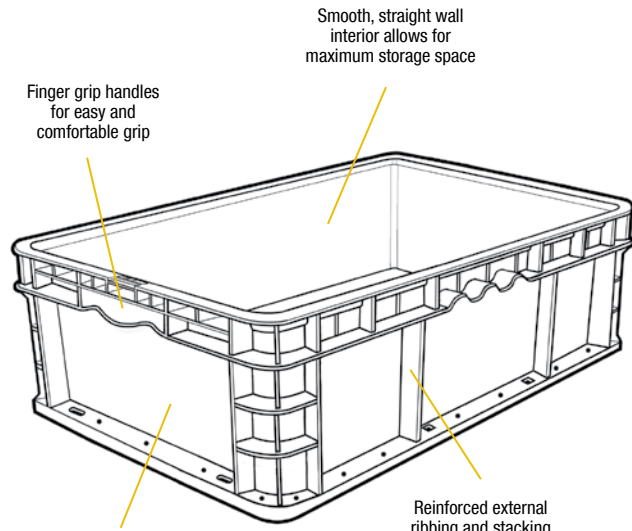

Flat surface ideal for labeling or bar coding parts. Optional 3" x 5" adhesive clear label holder and inserts attaches securely for easy part identification. **AL-35** package of 24

**MOBILIZE YOUR BINS**

**Polymer Dollies**

**DLY-2415** is 24"L x 15"W with 1" Ledge, available in Black.

**DLY-3018** is 30"L x 18"W with padded rubber trim, available in Blue.

Set of four 4" x 1-1/4" non-marking swivel poly casters.

Both dollies have up to 1,000 lb. load capacity.

MODEL NO.	DESCRIPTION	CTN WGT
<b>DLY-2415</b>	Dolly with 1" Ledge	14 lbs
<b>DLY-3018</b>	Dolly with Padded Rubber Trim	19 lbs

Bins sold separately

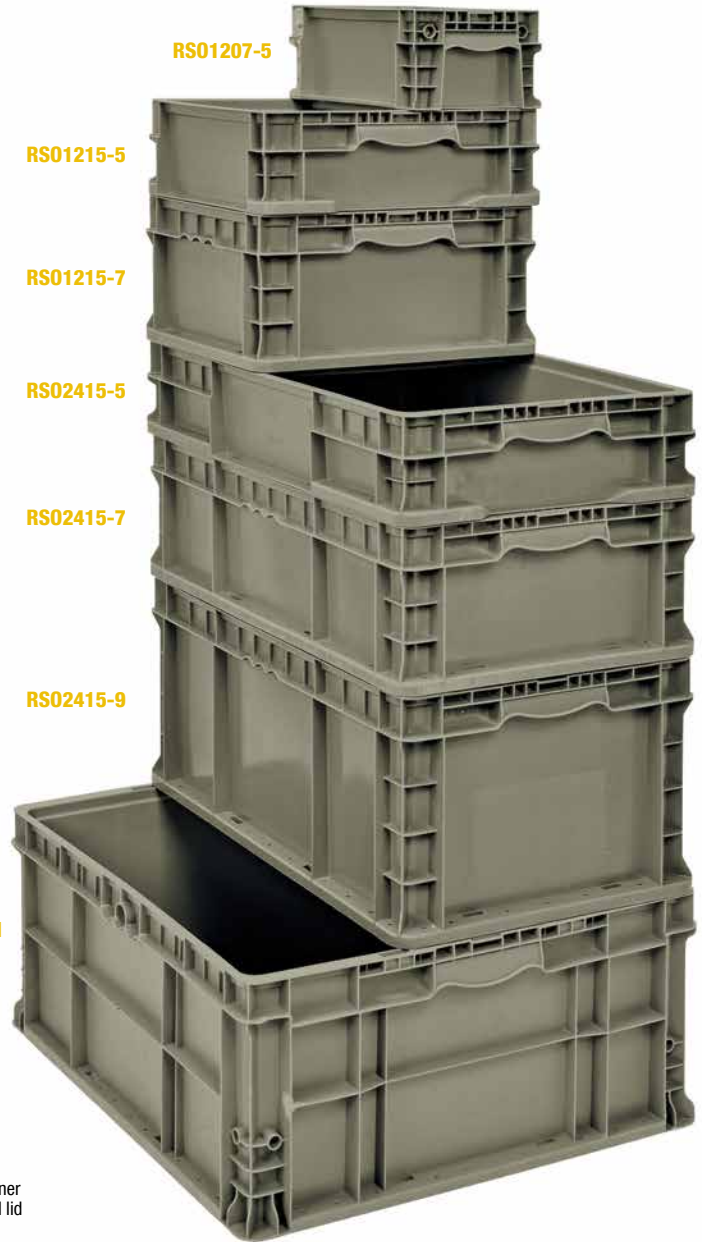

Straight Wall container shown with optional lid **LID2415** (Sold separately)



**DLY-2415**  
Interior Dimensions 24"L x 15"W  
Exterior Dimensions 28"L x 18-1/2"W



**LOWEST PRICE GUARANTEE**

Stronger corner design means increased durability which translates to fewer damaged containers

Secure plastic hinges make containers safer to handle and easier to recycle at end-of-life

# 9 SIZES AVAILABLE

QDC2115-12



**PLASTIC HINGE**  
generation plastic hinge



QDC2115-9

## Polymer Dolly

**DLY-2415** Dolly with 1" Ledge, available in Black. Up to 1,000 lb. load capacity. Interior Dimensions 24"L x 15"W Exterior Dimensions 28"L x 18-1/2"W

MODEL NO.	DESCRIPTION	CTN WGT
<b>DLY-2415</b>	Dolly with 1" Ledge	14 lbs

Bins sold separately

Enhanced nesting lug increases strength when stacking nested containers

Redesigned lid features additional ribbing in critical impact areas

QDC2115-17

## STRONG, RELIABLE, REUSABLE TOTES

QDC2012-7

QDC2213-12

QDC2420-12

QDC2820-15



QDC2515-14

QDC2717-12



QDL-2115

Distribution container has an optional 3" x 5" adhesive clear label holder and insert which attaches securely for easy part identification. Package of 24.

### Heavy-Duty Attached Top Containers - Perfect for distribution and supply centers



Strong, reliable and reusable totes are ideal for storage, distribution and order picking. Tops are permanently attached with hinges that interlock for stacking strength and security. Stack for maximized storage and nest when empty. Textured, non-slip bottom ensures smooth conveying. Ergonomically designed handles allow for easy lifting. Recessed lids ensure maximum load stability. Padlock eye provides security option allowing lids to be fastened and/or locked. Molded from high density, FDA approved polyethylene. Lids close securely to protect parts from dust or damage.



## CUSTOM COLORS AVAILABLE

call for details



## HOT STAMPING AVAILABLE

call for details

Available in: ● Gray ● Custom

MODEL NO.	OUTSIDE DIMENSIONS		INSIDE DIMENSIONS		OVERALL		CAP GAL	STACK CAP/ QTY STACKED	SHIP WGT
	TOP L" x W"	BOTTOM L" x W"	TOP L" x W"	BOTTOM L" x W"	CONTAINER HEIGHT	VOLUME CU FT			
<b>QDC2012-7</b>	19-5/8" x 11-9/16"	17" x 9-1/4"	17-9/16" x 9-13/16"	16-1/4" x 8-5/8"	7-1/2"	0.50	8.75	45 lbs/7	4 lbs
<b>QDC2115-9</b>	21-3/4" x 14-7/8"	18-15/16" x 13-1/8"	19-5/8" x 14"	18-3/8" x 12-9/16"	9-5/8"	1.27	9.50	65 lbs/5	6 lbs
<b>QDC2115-12</b>	21-3/4" x 15"	18-9/16" x 12-5/8"	19-3/4" x 14"	18" x 12-1/4"	12-3/4"	1.67	12.50	75 lbs/5	7 lbs
<b>QDC2115-17</b>	21-7/8" x 15-1/8"	18-3/8" x 12-7/8"	20" x 14-1/2"	17-7/8" x 12-1/2"	17-1/4"	2.31	17.25	100 lbs/3	8 lbs
<b>QDC2213-12</b>	22-1/8" x 12-5/8"	18-7/8" x 10-7/8"	19-7/8" x 12"	18-1/2" x 10-1/8"	11-7/8"	1.42	12.25	75 lbs/5	6 lbs
<b>QDC2420-12**</b>	23-7/8" x 19-3/8"	21-1/4" x 17-5/16"	22-1/4" x 18"	20-5/8" x 16-5/8"	12-1/2"	2.44	18.25	85 lbs/5	8 lbs
<b>QDC2717-12</b>	27-5/16" x 16-9/16"	24-1/4" x 14-1/2"	25-1/8" x 15-3/8"	23-3/8" x 13-3/4"	12-1/2"	2.50	18.75	100 lbs/4	8 lbs
<b>QDC2515-14</b>	25-3/8" x 16-1/4"	22-1/4" x 13-1/4"	23-1/8" x 14-1/4"	21-5/8" x 12-5/8"	14-1/8"	2.20	16.50	100 lbs/4	8 lbs
<b>QDC2820-15*</b>	28-1/8" x 20-5/8"	25-3/8" x 18-3/4"	25-7/8" x 19-3/4"	25-1/8" x 18"	15-5/8"	4.00	29.92	100 lbs/4	13 lbs

\*Cannot be used on DLY-2415, use with DLY-3018 Dolly \*\*Manufactured with metal hinge

Collapsible Bulk Box



Quantum's Collapsible Bulk Box provides an efficient approach to large volume or large part material handling, storage and transport. Used for heavy loads, components and even food products, these reusable and returnable containers allow you to ship, handle, pick, store and distribute your products while increasing productivity and profitability. Quantum's Collapsible Bulk Box comes in a standard pallet size footprint measuring 48"L x 45"W. It can be collapsed down to a fraction of its full height in seconds. Bulk containers stack perfectly loaded or when folded down to minimize storage space. They are designed to make the shipping of your products faster, safer and less costly while providing greater protection. Two access drop doors are able to lie flush against the container allowing easy loading and unloading. Manufactured from High Density Polyethylene, this tough container provides superior protection for products while being stored or in transit. Welded base provides greater strength while the reinforced fork openings provide easy lifting. Can withstand temperatures between -20° and 250°F. Optional lid available to cover contents inside (Model No: LID-4845).

HANDLE, SHIP, DISTRIBUTE, REUSE



Fully expanded Bulk Box measures 48"L x 45"W x 34"H (Lid LID-4845 Sold separately)



Two access drop doors allows easy loading and unloading



Easy opening and collapsing of Bulk Box's side walls



Collapses to 12-3/4"; a fraction of its full height



QBB-4845-34

PERFORMANCE FEATURES:

- Plastic, ergonomic latches for opening and collapsing
- Superior strength with low tare weight
- High return ratio: return 3 collapsed boxes for each bulk box distributed
- Up to 1,800 lb. load capacity for standard usage
- Large, flat labeling area on all four sides

Available in: ● Black

MODEL NO.	L (INCH/MM)	W (INCH/MM)	H (INCH/MM)
QBB-4845-34			
External	48.00/1219.2	45.00/1143.0	33.9/861.1
Internal	44.50/1130.3	41.50/1054.1	28.2/716.0
Usable Interior Height (Fill line)	-	-	27.10/688.3
Access Drop Door - Cut Out	-	30.00/762.0	15.95/405.1
Collapsed Height	-	-	12.76/324.0
Nested Height	-	-	11.77/299.0
Stack of 9/Collapsed (Trailer)	-	-	106.93/2716.1
Fork Tunnel - 48" Side	-	11.00/279.4	3.40/86.4
Fork Tunnel - 45" Side	-	11.38/288.9	3.40/86.4
Ship wgt. - 118 lbs			



**Mobile Frames**

MODEL NO.	DIMENSIONS D" x W" x H"	SHIP WGT
<b>Single Sided Mobile Frame</b>		
TTS-18	18" x 38" x 67"	170 lbs
TTS-24	24" x 38" x 67"	174 lbs
<b>Double Sided Mobile Frame</b>		
TTD-30	30" x 38" x 67"	178 lbs
TTD-40	40" x 38" x 67"	184 lbs



**Single and Double Sided Removable Tray Trucks**

All welded construction with 1-1/2" square tubular frame. Slotted 12 gauge channel uprights (slots on 3-1/2" centers). Bolt on casters, 2 swivel and 2 rigid, for ease of replacement and superior cart tracking. Open and closed front trays and tray dividers sold separately.

**Up to 2,000 lb.**  
LOAD CAPACITY

**Removable Trays**

MODEL NO.	DIMENSIONS D" x W" x H"	SHIP WGT	TRAY DIVIDER MODEL NO.	QUANTITY OF TRAYS TO FIT MOBILE FRAMES			
				FRAME TTS-18	FRAME TTS-24	FRAME TTD-30	FRAME TTD-40
<b>Open Front Trays</b>							
TT-OT9	9" x 36" x 3"	16 lbs	TT-DIV3	14	14	28	28
TT-OT15	15" x 36" x 6"	28 lbs	TT-DIV6	-	-	-	14
<b>Closed Front Trays</b>							
TT-CT9	9" x 36" x 3"	16 lbs	TT-DIV3	14	14	28	28
TT-CT15	15" x 36" x 6"	28 lbs	TT-DIV6	-	-	-	14



**TT-OT15**  
Open Tray



**TT-CT15**  
Closed Tray

**12 GAUGE**  
**SUPREME HEAVY-DUTY**  
**SUPER STRONG**



Order this exact unit

**TTD-OT15-240**

Unit consists of:

**1** - double sided frame **TTD-40**

**10** - open front trays **TT-OT15**

**40** - bins **QUS240** available in Blue, Green, Ivory, Red, Yellow, Black or Clear

**MAGNUM Bin Transport Trucks**



All welded construction with 1-1/2" x 3/16" thick angle frame construction. Twin 1-1/4" tubular handles with smooth radius bend. Bolt on polyurethane casters, 2 swivel and 2 rigid, for easy push and pull and superior tracking.

Bins available in: ● Blue ● Green ● Red ● Yellow ● Black (One color per unit)

MODEL NO.	DIMENSIONS D" x W" x H"	NO. OF BINS	BIN DIMENSIONS L" x W" x H"	SHIP WGT
<b>5" x 1-1/4" - Polyurethane Casters - Up To 1,200 lb. Load Capacity</b>				
MTT-1842-543	18" x 42" x 47"	6	19-3/4" x 18-3/8" x 11-7/8"	204 lbs
MTT-3042-743	30" x 42" x 47"	6	29" x 18-3/8" x 11-7/8"	238 lbs
<b>5" x 2" - Polyurethane Casters - Up To 3,000 lb. Load Capacity</b>				
MTT-1860-543	18" x 60" x 47"	9	19-3/4" x 18-3/8" x 11-7/8"	256 lbs
MTT-3060-743	30" x 60" x 47"	9	29" x 18-3/8" x 11-7/8"	290 lbs
MTT-1878-543	18" x 78" x 47"	12	19-3/4" x 18-3/8" x 11-7/8"	332 lbs
MTT-3078-743	30" x 78" x 47"	12	29" x 18-3/8" x 11-7/8"	380 lbs

**CART OFFERS Up to 1,200 lb. LOAD CAPACITY**



**MTT-1842-543**  
18"D x 42"W x 47"H  
6 bins QMS543  
19-3/4"L x 18-3/8"W x 11-7/8"H bins



**MTT-3060-743**  
30"D x 60"W x 47"H  
9 bins QMS743  
29"L x 18-3/8"W x 11-7/8"H bins

**MAGNUM**

AVAILABLE on pg. 47

**CART OFFERS Up to 3,000 lb. LOAD CAPACITY**



**MTT-1878-543**  
30"D x 78"W x 47"H  
12 bins QMS543  
19-3/4"L x 18-3/8"W x 11-7/8"H bins



**PC4026-33**  
40"L x 26"W x 32-1/2"H

**CART OFFERS**  
**Up to 500 lb.**  
**LOAD CAPACITY**



**PFTC4026-33-3**  
40"L x 26"W x 32-1/2"H



**PFTC4026-33-2**  
40"L x 26"W x 32-1/2"H



**PC4026-33-3**  
40"L x 26"W x 32-1/2"H



**PC3518-33-3**  
34-1/4"L x 17-1/2"W x 32-1/2"H

**Polymer Utility Carts**

Industrial strength cart is ideal for many industrial and commercial material handling applications. Set of 2 swivel and 2 rigid 5" x 1-1/4" heavy-duty casters allow for up to 550 lb. load capacity. Available in two sizes with a 2 or 3 shelf combination.

**RUGGED, HEAVY-DUTY, DURABLE**

Available in: ● Gray

MODEL NO.	OUTSIDE DIMENSIONS L" x W" x H"	INSIDE SHELF DIMENSIONS L" x W" x H"	NO. OF SHELVES	SHIP WGT
<b>PC3518-33</b>	34-1/4" x 17-1/2" x 32-1/2"	29-1/4" x 15-1/4" x 2-5/8"	2	38 lbs
<b>PC3518-33-3</b>	34-1/4" x 17-1/2" x 32-1/2"	29-1/4" x 15-1/4" x 2-5/8"	3	51 lbs
<b>PC4026-33</b>	40" x 26" x 32-1/2"	35" x 23" x 2-5/8"	2	54 lbs
<b>PC4026-33-3</b>	40" x 26" x 32-1/2"	35" x 23" x 2-5/8"	3	74 lbs

**Polymer Flat Top Shelf Cart**

<b>PFTC4026-33-2</b>	40" x 26" x 32-1/2"	35" x 23"*	2	51 lbs
<b>PFTC4026-33-3</b>	40" x 26" x 32-1/2"	35" x 23"*	3	71 lbs

**Additional Shelves**

<b>PC3518SHELF</b>	34-1/4" x 17-1/2" x 4-3/16"	29-1/4" x 15-1/4" x 2-5/8"	1	13 lbs
<b>PC4026SHELF</b>	40" x 26" x 4-3/16"	35" x 23" x 2-5/8"	1	20 lbs

**Replacement Casters**

<b>PC-CAS-SW</b>	One Replacement Swivel Caster	2 lbs
<b>PC-CAS-RG</b>	One Replacement Rigid Caster	2 lbs

\*Inside dimension for middle and bottom shelf 35" x 23" x 2-5/8"

Shown with optional Tool Holder Attachment



**PC3518-33 + PCTH**  
34-1/4"L x 17-1/2"W x 32-1/2"H  
Shown with optional Tool Holder  
(Tools not included)

**Plastic Cart Tool Holder Attachment**

Available in: ● Red and Gray

MODEL NO.	DESCRIPTION	SHIP WGT
<b>PCTH</b>	96 Piece Tool Holder and Cart Attachment	3 lbs

Patent Pending

**Tool Rack**

Space saving Tool Rack is manufactured from durable polypropylene. Get organized with this tough rack that will not warp or bend even when it is loaded to capacity. Holds up to 96 items. Mounting hardware is not included.

Available in: ● Red

MODEL NO.	OUTSIDE DIMENSIONS L" x W" x H"	CTN QTY	CTN WGT
<b>TR-96</b>	6" x 24-1/8" x 2-3/4"	12	9 lbs



**TR-96**

**Tool Caddy**



Industrial strength, hand-held caddy ideal for tools and supplies. This portable, high density polypropylene caddy has extra strength ribs for support. Deep compartments make transporting tools, supplies and loose parts super easy.

Available in: ● Blue ● Gray

MODEL NO.	OUTSIDE DIMENSIONS L" x W" x H"	CTN QTY	CTN WGT
<b>TC-500</b>	13-3/8" x 18-1/4" x 5-1/2"	6	14 lbs

\*Overall height including handle is 9-1/8"



TC-500



Industrial-strength polypropylene

Deep compartments are ideal for automotive parts, hardware or cleaning supplies. Inside pockets measures 16-3/4"L x 4-1/2"W

Perfect for tools, parts and janitorial supplies



Comfortable grip handle even when carrying heavy loads 9-1/8"H

**Tool Box**



This tough Tool Box will not warp or bend even when it is loaded to capacity. Ideal for carrying hand tools, hardware or small to medium sized items. Handle provides comfortable smooth grip. Flush top surface for convenient stacking and storing. Manufactured from heavy-duty polypropylene.

Available in: ● Red ● Clear

MODEL NO.	OUTSIDE DIMENSIONS L" x W" x H"	CTN QTY	CTN WGT
<b>TB12</b>	5-1/2" x 12" x 4-1/8"	12	9 lbs
<b>TB12CL</b>	5-1/2" x 12" x 4-1/8"	12	9 lbs



TB12CL

**IDEAL FOR CARRYING HAND TOOLS**



TB12

**TOUGH, DURABLE, LOW COST**



NPB1076



**Economy All-Purpose Nesting Parts Bin**



Organize your small to medium parts with our tough, durable, high density Nesting Parts Bins. Bins save space and nest when empty. Manufactured from heavy-duty polypropylene.

Available in: ○ White ● Black

MODEL NO.	OUTSIDE DIMENSIONS L" x W" x H"	INSIDE BOTTOM DIMENSIONS L" x W" x H"	CTN QTY	CTN WGT
<b>NPB1076</b>	10-1/4" x 7-1/2" x 6"	8" x 5-1/2" x 5-3/4"	20	10 lbs

Inside top width: 6-1/2" Inside height to open hopper front: 3-3/4"

**HEAVY-DUTY INDUSTRIAL-STRENGTH PLASTIC**

**Wrench Holder**



Versatile Wrench Holder can be mounted on any wall surface. Manufactured from high impact polystyrene and can hold up to 15 wrenches of different sizes. Mounting hardware is not included.

Available in: ● Black

MODEL NO.	OUTSIDE DIMENSIONS L" x W" x H"	CTN QTY	CTN WGT
<b>WH-15</b>	1" x 7-1/8" x 11-5/8"	12	5 lbs



**WH-15**  
(Wrenches not included)

**Bin, Tote and Container Labels**



Labels facilitate parts identification and bar coding of the bin contents. Label sizes and availability vary per product. Correct labeling option(s) are specified alongside products details shown throughout the catalog.

**INSERTS INCLUDED**

**Clear Label Holders and Inserts**

Clear Label Holders easily slide into molded-in label slot on bin to protect label. Laser and inkjet compatible inserts come in 8-1/2" x 11" perforated sheets. Each package includes 25 clear holders and corresponding printer friendly sheet labels.

**6 MODELS AVAILABLE**

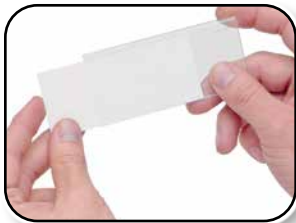

LTR-700, LTR-0813, LTR-1253, LTR-1300, LTR-1754, LTR-2400

**Adhesive Label Holders and Inserts**

Adhesive Label Holders are designed to work with bins without molded-in label slots. These label holders will attach securely to a flat surface. Laser and inkjet compatible inserts come in 8-1/2" x 11" perforated sheets. Each package includes 24 adhesive holders and corresponding printer friendly sheet labels.



AL-23



AL-35

**Bin Rear Label Holder**

New Rear Bin Label Holder clips to the back portion of any plastic bin. Creates a vertical extension for a 1" x 3" label or barcode making it easy to identify the contents of that bin. Each package includes 12 clear holders and corresponding printer friendly sheet labels.



RLH1X3C

**INSERTS NOT INCLUDED**

**Label Holders for Dividable Grid Containers**

Label Holders are available for standard and conductive dividable grid containers. Three sizes to choose from (2" x 8", 3" x 5" and 5" x 8"). Package of 6.



CLEAR LABEL HOLDER



CONDUCTIVE LABEL HOLDER

**Clear Hanging Label Holder**

3" x 5" Clear Hanging Label Holder securely attaches to all sizes of stack and nest totes and cross stack tubs. Label holder can be used on totes and tubs with or without lids for easy part identification. Package of 6.



FITS ALL CROSS STACK TUBS



snh010

FITS ALL stack and nest TOTES

**Extended Label Holders**

Extended Label Holders are designed to slide into the molded label slot of bins to allow for larger bar code scanning or just larger labels. Label holders fit all 4", 6" and 8" Shelf Bins. Provides a 4" x 2-1/4" flat angled surface. Package of 24.

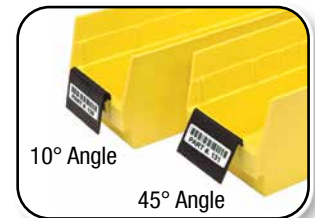

ELH410 and ELH445

**Divider Label Tab**

Divider Label Tabs attach directly to existing dividers enabling sections of bin to be labeled. Multiple tabs improve the visibility of bin labels and scanning of barcodes. Package of 6.



DLT-6

**Plastic Drawer Cabinets**

- Heavy-duty reinforced construction.
- Each see through drawer includes a divider.
- Stable stacking and easy wall mounting with pre-configured holes on rear side.
- Drawer stops on each drawer prevents spills.
- Textured drawer pull surface.
- Durable high impact polypropylene frame with clear polypropylene drawers and bins.

Available in: ● Black and Gray

MODEL NO.	OUTSIDE DIMENSIONS L" x W" x H"	DRAWER QTY	DRAWER DIMENSIONS L" x W" x H"	PKG QTY	PKG WGT
<b>PDC-12BK</b>	6-1/4" x 10-1/2" x 10-1/4"	8 Drawers 4 Drawers	5-1/2" x 2" x 1-1/4" 5-1/2" x 4-1/4" x 2"	1	3 lbs
<b>PDC-18BK</b>	6-1/4" x 15" x 18-3/4"	18 Drawers	5-1/2" x 4-1/4" x 2"	1	5 lbs
<b>PDC-22BK</b>	6-1/4" x 19-1/2" x 10"	14 Drawers 8 Drawers	5-1/2" x 2" x 1-1/4" 5-1/2" x 4-1/4" x 2"	1	5 lbs
<b>PDC-39BK</b>	6-1/4" x 15" x 18-3/4"	30 Drawers 9 Drawers	5-1/2" x 2" x 1-1/4" 5-1/2" x 4-1/4" x 2"	1	6 lbs
<b>PDC-60BK</b>	6-1/4" x 15" x 18-3/4"	60 Drawers	5-1/2" x 2" x 1-1/4"	1	7 lbs
<b>PDC-930BK</b>	6-1/4" x 15" x 18-3/4"	30 Drawers 9 Bins	5-1/2" x 2" x 1-1/4" 5-1/2" x 4-1/4" x 2-3/4"	1	6 lbs



**PDC-12BK**



**PDC-18BK**

**EASY TO IDENTIFY ITEMS INSIDE**



**PDC-22BK**



**PDC-39BK**



**PDC-60BK**



**PDC-930BK**



**SINGLE SIDED**

**ORG80032**  
Single Sided Organizer

- Offers up to 17 storage compartments.
- Includes 12 dividers allowing you to customize the size of the desired compartments inside.

**Mobile Organizers**

Clear lid design allows quick identification of parts inside. Unique latch design enables lid to close and latch tight and secure. Dividers prevent parts from migrating between various compartments. Organizers manufactured from industrial grade polypropylene.

Available in: ● Black, Red and Clear

MODEL NO.	OUTSIDE DIMENSIONS L" x W" x H"	CTN QTY	CTN WGT
<b>Single Sided</b>			
<b>ORG80032</b>	12-1/2" x 10" x 2-1/4"	6	7 lbs
<b>ORG81532</b>	15" x 12-1/4" x 2-3/4"	6	11 lbs
<b>ORG81832</b>	18" x 14" x 3"	4	12 lbs
<b>Double Sided</b>			
<b>ORG80322</b>	12-1/4" x 10-1/4" x 3"	5	9 lbs



**SINGLE SIDED**

**ORG81532**  
Single Sided Organizer

- Offers up to 23 storage compartments.
- Includes 18 dividers allowing you to customize the size of the desired compartments inside.



**SINGLE SIDED**

**ORG81832**  
Single Sided Organizer

- Offers up to 26 storage compartments.
- Includes 21 dividers allowing you to customize the size of the desired compartments inside.



**DOUBLE SIDED**

**ORG80322**  
Double Sided Organizer

- Offers up to 32 storage compartments.
- Includes 24 dividers allowing you to customize the size of the desired compartments inside.



**DIVIDERS INCLUDED**

**Clear Compartment Storage Boxes**

Utility boxes offer compartments for small and medium parts storage. Manufactured of clear, see-through polypropylene.

Available in: ● Clear

MODEL NO.	OUTSIDE DIMENSIONS L" x W" x H"	CTN QTY	CTN WGT
<b>Removable Dividers</b>			
<b>QB200</b>	5-1/2" x 2-3/4" x 1-1/4"	12	2 lbs
<b>QB300</b>	6-3/4" x 4-3/4" x 2-1/4"	12	4 lbs
<b>QB400</b>	7-3/4" x 5-1/2" x 1-3/4"	12	5 lbs
<b>QB600</b>	9-1/4" x 6-1/4" x 2-1/5"	6	4 lbs
<b>QB800</b>	11-3/4" x 7-3/4" x 2-1/5"	6	5 lbs
<b>Fixed Dividers</b>			
<b>QB900</b>	10-1/4" x 13" x 2-3/8"	12	8 lbs



**QB900**  
● Organizer has 10 fixed compartments.



**QB200**  
● Includes 2 fixed and 6 removable dividers creating 3-8 compartments.



**QB300**  
● Includes 5 removable dividers creating 1-6 compartments.

**COMPARTMENTS FOR SMALL AND MEDIUM SIZED PARTS**



**QB800**



**QB400**  
● Includes 1 fixed and 6 removable dividers creating 2-8 compartments.



**QB600**  
● Includes removable tray and 3 removable dividers creating 1-8 compartments.



**QB800**  
● Includes 6 removable dividers creating 1-10 compartments.

**Environmentally Friendly Recycled Bins**



Manufactured from recycled, 100% post consumer, high density polypropylene, these bins come in a complete range of sizes and have all the features of Quantum's standard bins at a more economical price. Available in Black only.



**Recycled Ultra Hang & Stack Bins**

See pg. 5 for additional information on Ultra Hang & Stack Bins and to order window fronts, clear lids or dividers.



Available in: ●Black

MODEL NO.	OUTSIDE DIMENSIONS L" x W" x H"	CTN QTY	CTN WGT
QUS210BR	5-3/8" x 4-1/8" x 3"	24	6 lbs
QUS220BR	7-3/8" x 4-1/8" x 3"	24	8 lbs
QUS221BR	9-1/4" x 6" x 5"	12	6 lbs
QUS224BR	10-7/8" x 4-1/8" x 4"	12	8 lbs
QUS230BR	10-7/8" x 5-1/2" x 5"	12	10 lbs
QUS232BR	5-3/8" x 11" x 3"	8	5 lbs
QUS234BR	14-3/4" x 5-1/2" x 5"	12	14 lbs
QUS235BR	10-7/8" x 11" x 5"	6	10 lbs
QUS236BR	7-3/8" x 11" x 3"	8	9 lbs
QUS238BR	18" x 5-1/2" x 5"	12	16 lbs
QUS239BR	10-3/4" x 8-1/4" x 7"	6	10 lbs
QUS240BR	14-3/4" x 8-1/4" x 7"	12	24 lbs
QUS241BR	13-5/8" x 8-1/4" x 6"	12	22 lbs
QUS242BR	13-5/8" x 8-1/4" x 8"	12	25 lbs
QUS245BR	10-7/8" x 16-1/2" x 5"	6	13 lbs
QUS248BR	18" x 8-1/4" x 7"	6	19 lbs
QUS250BR	14-3/4" x 16-1/2" x 7"	6	21 lbs
QUS255BR	16" x 11" x 8"	4	14 lbs
QUS260BR	18" x 11" x 10"	4	17 lbs
QUS265BR	18" x 8-1/4" x 9"	6	17 lbs
QUS270BR	18" x 16-1/2" x 11"	3	16 lbs
QUS275MOBRR	18" x 16-1/2" x 11"	3	25 lbs
QGH700BR	15-1/4" x 19-7/8" x 12-7/16"	3	13 lbs

**Recycled Shelf Bins**

See pg. 50 for additional information on Shelf Bins and to order dividers and bin cups.



Available in: ●Black

MODEL NO.	OUTSIDE DIMENSIONS L" x W" x H"	CTN QTY	CTN WGT
QSB100BR	11-5/8" x 2-3/4" x 4"	36	10 lbs
QSB101BR	11-5/8" x 4-1/8" x 4"	36	13 lbs
QSB102BR	11-5/8" x 6-5/8" x 4"	30	15 lbs
QSB107BR	11-5/8" x 8-3/8" x 4"	20	12 lbs
QSB109BR	11-5/8" x 11-1/8" x 4"	8	7 lbs
QSB118BR <b>NEW</b>	11-5/8" x 16-1/2" x 4"	6	7 lbs
QSB103BR	17-7/8" x 4-1/8" x 4"	20	11 lbs
QSB104BR	17-7/8" x 6-5/8" x 4"	20	15 lbs
QSB108BR	17-7/8" x 8-3/8" x 4"	10	11 lbs
QSB110BR	17-7/8" x 11-1/8" x 4"	8	10 lbs
QSB122BR <b>NEW</b>	17-7/8" x 16-1/2" x 4"	6	10 lbs
QSB105BR	23-5/8" x 4-1/8" x 4"	16	13 lbs
QSB106BR	23-5/8" x 6-5/8" x 4"	8	9 lbs
QSB114BR	23-5/8" x 8-3/8" x 4"	6	8 lbs
QSB116BR	23-5/8" x 11-1/8" x 4"	6	9 lbs

**Recycled MAGNUM Bins**

See pg. 47 for additional information on MAGNUM Bins and to order windows, dividers or a mobile option.



Available in: ●Black

MODEL NO.	OUTSIDE DIMENSIONS L" x W" x H"	CTN QTY	CTN WGT
QMS531BR	19-3/4" x 12-3/8" x 5-7/8"	6	19 lbs
QMS532BR	19-3/4" x 12-3/8" x 7-7/8"	6	23 lbs
QMS533BR	19-3/4" x 12-3/8" x 11-7/8"	3	15 lbs
QMS543BR	19-3/4" x 18-3/8" x 11-7/8"	1	8 lbs
QMS743BR	29" x 18-3/8" x 11-7/8"	1	10 lbs

**MANUFACTURED FROM RECYCLED, 100% POST CONSUMER, HIGH DENSITY POLYPROPYLENE**

**Conductive Ultra Stack Bins & Dividers**



Protect your electronic components from typical electromagnetic interference (EMI), electrostatic or induced fields with these conductive polypropylene bins. The conductive material provides a barrier which these fields cannot penetrate and prevents the build-up of an electrostatic charge. Bins are permanently conductive and are unaffected by washing with normal cleaners. Molded from a carbon filled copolymer polypropylene material with an electrostatic decay rate at less than 0.1 second that meets conductivity standards as tested with ASTM-D257 methods. Its surface resistivity is less than 10<sup>9</sup> Ohms-per square. Easy access to stored items with hopper front bin and label holder provides fast identification. Reinforced side walls and wide ledge allow high stacking on benches or shelving. Be sure all bins are properly grounded according to your use.

Available in: ● Black

MODEL NO.	OUTSIDE DIMENSIONS L" x W" x H"	CTN QTY	CTN WGT	DIVIDER	CTN QTY
<b>QUS210CO</b>	5-3/8" x 4-1/8" x 3"	24	6 lbs	<b>DUS210CO</b>	6
<b>QUS220CO</b>	7-3/8" x 4-1/8" x 3"	24	8 lbs	<b>DUS220CO</b>	6
<b>QUS230CO</b>	10-7/8" x 5-1/2" x 5"	12	12 lbs	<b>DUS230CO</b>	6
<b>QUS235CO</b>	10-7/8" x 11" x 5"	6	10 lbs	<b>DUS235CO</b>	6
<b>QUS239CO</b>	10-3/4" x 8-1/4" x 7"	6	10 lbs	<b>DUS239CO</b>	6
<b>QUS240CO</b>	14-3/4" x 8-1/4" x 7"	12	24 lbs	<b>DUS240CO</b>	6
<b>QUS250CO</b>	14-3/4" x 16-1/2" x 7"	6	21 lbs	<b>DUS250CO</b>	6
<b>QUS255CO</b>	16" x 11" x 8"	4	14 lbs	<b>DUS255CO</b>	6
<b>QUS260CO</b>	18" x 11" x 10"	4	17 lbs	<b>DUS260CO</b>	6
<b>QUS270CO</b>	18" x 16-1/2" x 11"	3	16 lbs	<b>DUS270CO</b>	6

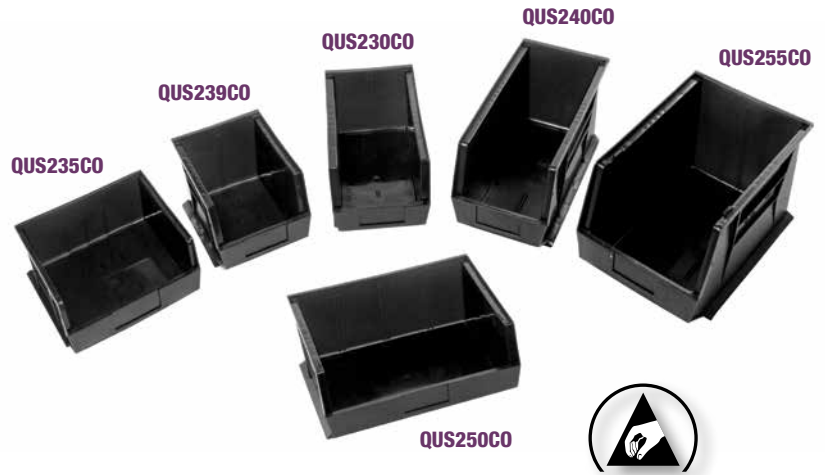

**LARGEST CONDUCTIVE SELECTION AVAILABLE ANYWHERE**

**CUSTOMIZE YOUR OWN UNIT**

1. Select the hanging unit of your choice.
2. Use the chart across and choose the bin that best fits your need.
3. Go to the chart at the bottom of this page and determine how many bins fit on the unit you selected.
4. Place your order for both unit and bins.

**Wire Louvered Panels**

**WALL MOUNT YOUR CONDUCTIVE BINS**

Quantum's new chrome Wire Louvered Panels offer a perfect mounting solution for all plastic hanging and new wire mesh hanging bins. Quantum's exclusive offering of wire panels, available in three sizes, completely resist any buildup of dust or dirt. Included direct mounting clips enable fastening to any surface (wall, wood, concrete, drywall, etc.) a snap. Manufactured of heavy-duty chrome wire, Quantum's wire panels will offer years of dependable and heavy-duty service.

**GROUND WIRE ALLOWS STATIC CHARGE TO BE DISSIPATED KEEPING BIN CONTENTS SAFE**

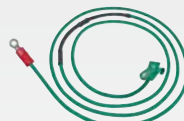

**GRD-WR**  
Ground Wire  
(Sold separately)

**SIMPLE TO MOUNT  
EASY TO CLEAN  
ALL WELDED**



**WLP-1836C**

36"L x 18"H Includes 8 direct mount clips. Up to 175 lb. load capacity.

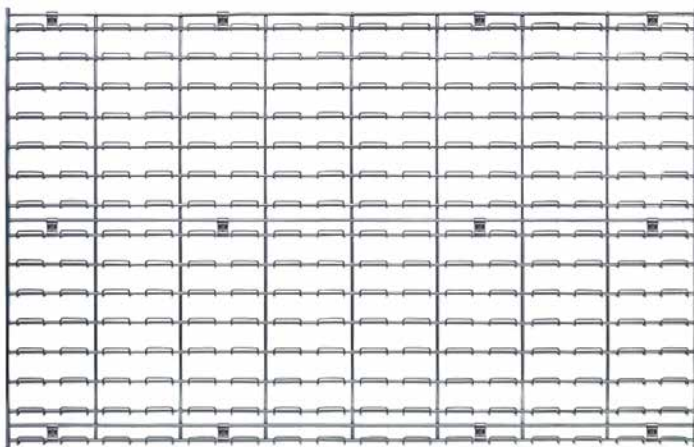

**WLP-3048C**

48"L x 30"H Includes 12 direct mount clips. Up to 250 lb. load capacity.

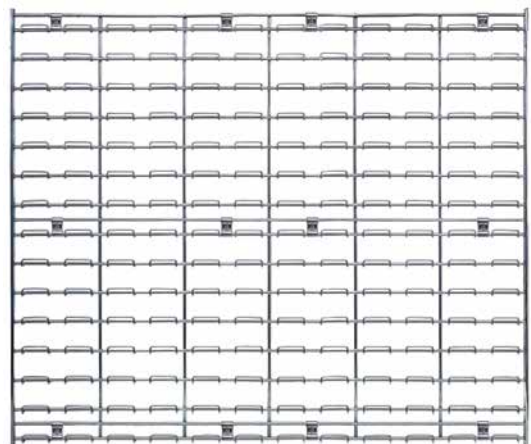

**WLP-3036C**

36"L x 30"H Includes 12 direct mount clips. Up to 175 lb. load capacity.

MODEL NO.	QUANTITY OF ULTRA BINS TO FIT LOUVERED PANELS									
	QUS 210CO	QUS 220CO	QUS 230CO	QUS 235CO	QUS 239CO	QUS 240CO	QUS 250CO	QUS 255CO	QUS 260CO	QUS 270CO
<b>WLP-1836C</b>	32	32	18	9	8	8	4	6	3	2
<b>WLP-3036C</b>	56	56	30	15	16	16	6	9	6	6
<b>WLP-3048C</b>	77	77	40	20	20	20	8	12	12	6

See chart above for bin dimensions

**Conductive Shelf Bins**



Protect your electronic components from typical electro-magnetic interference (EMI), electrostatic or induced fields with these molded, carbon-filled, copolymer polypropylene bins. Surface resistivity is less than 10<sup>5</sup> Ohms-per square. Easy access to stored items with hopper front bin and label holder provides fast identification. The conductive material provides a barrier which these fields cannot penetrate and prevents the build-up of electrostatic charge. Bins are permanently conductive and are unaffected by washing with normal cleaners. Be sure all bins are properly grounded according to your application.

Available in: ● Black

MODEL NO.	OUTSIDE DIMENSIONS L" x W" x H"	CTN QTY	CTN WGT	DIVIDER	CTN QTY
QSB100CO	11-5/8" x 2-3/4" x 4"	36	13 lbs	-	-
QSB101CO	11-5/8" x 4-1/8" x 4"	36	17 lbs	DSB101CO	50
QSB102CO	11-5/8" x 6-5/8" x 4"	30	18 lbs	DSB102CO	50
QSB107CO	11-5/8" x 8-3/8" x 4"	20	15 lbs	DSB107CO	50
QSB109CO	11-5/8" x 11-1/8" x 4"	8	7 lbs	DSB109CO	50
QSB103CO	17-7/8" x 4-1/8" x 4"	20	13 lbs	DSB103CO	50
QSB104CO	17-7/8" x 6-5/8" x 4"	20	16 lbs	DSB104CO	50
QSB108CO	17-7/8" x 8-3/8" x 4"	10	11 lbs	DSB108CO	50
QSB110CO	17-7/8" x 11-1/8" x 4"	8	11 lbs	DSB110CO	50
QSB105CO	23-5/8" x 4-1/8" x 4"	16	13 lbs	DSB105CO	50
QSB106CO	23-5/8" x 6-5/8" x 4"	8	9 lbs	DSB106CO	50
QSB114CO	23-5/8" x 8-3/8" x 4"	6	9 lbs	DSB114CO	50
QSB116CO	23-5/8" x 11-1/8" x 4"	6	10 lbs	DSB116CO	50

**13 SIZES AVAILABLE**



**12", 18" AND 24" DEPTHS**

**Conductive Complete Bin Center**

Complete bin systems are available with 4 different size bins on a 12"W x 36"L x 36"H unit. This all-purpose bin center is an economical high density storage system that provides easy visibility to stored contents.

MODEL NO.	NO. OF BINS	BIN DIMENSIONS L" x W" x H"	SHIP WGT
<b>12"W x 36"L x 36"H - 6 Shelf Systems</b>			
WR6-36-1236-101CO	40 QSB101CO	11-5/8" x 4-1/8" x 4"	63 lbs
WR6-36-1236-102CO	25 QSB102CO	11-5/8" x 6-5/8" x 4"	50 lbs
WR6-36-1236-107CO	20 QSB107CO	11-5/8" x 8-3/8" x 4"	62 lbs
WR6-36-1236-109CO	15 QSB109CO	11-5/8" x 11-1/8" x 4"	64 lbs

**Conductive Shelf Bin Wire Shelving Systems - Complete Packages**

MODEL NO.	NO. OF BINS	BIN DIMENSIONS L" x W" x H"	SHIP WGT
<b>12"W x 36"L x 74"H - 12 Shelf Systems</b>			
WR12-101CO	88 QSB101CO	11-5/8" x 4-1/8" x 4"	120 lbs
WR12-102CO	55 QSB102CO	11-5/8" x 6-5/8" x 4"	116 lbs
WR12-107CO	44 QSB107CO	11-5/8" x 8-3/8" x 4"	117 lbs
WR12-109CO	33 QSB109CO	11-5/8" x 11-1/8" x 4"	119 lbs
<b>18"W x 36"L x 74"H - 12 Shelf Systems</b>			
WR12-103CO	88 QSB103CO	17-7/8" x 4-1/8" x 4"	176 lbs
WR12-104CO	55 QSB104CO	17-7/8" x 6-5/8" x 4"	165 lbs
WR12-108CO	44 QSB108CO	17-7/8" x 8-3/8" x 4"	170 lbs
WR12-110CO	33 QSB110CO	17-7/8" x 11-1/8" x 4"	168 lbs
<b>24"W x 36"L x 74"H - 12 Shelf Systems</b>			
WR12-105CO	88 QSB105CO	23-5/8" x 4-1/8" x 4"	228 lbs
WR12-106CO	55 QSB106CO	23-5/8" x 6-5/8" x 4"	218 lbs
WR12-114CO	44 QSB114CO	23-5/8" x 8-3/8" x 4"	222 lbs
WR12-116CO	33 QSB116CO	23-5/8" x 11-1/8" x 4"	206 lbs

**CONVERT STANDARD WIRE SHELVING INTO CONDUCTIVE SHELVING WITH THESE ACCESSORIES THAT ARE INCLUDED WITH THESE PACKAGES**



ESD-DC Drag Chain



WR-SSCO Plastic Conductive Split Sleeve



**Up to 800 lb. LOAD CAPACITY PER SHELF**

**MOBILIZE YOUR WIRE SHELVING**

**DB - Donut Bumper**  
Non-marking donut bumper used to protect walls and help cushion impact.

**WR-00CO (Mobile Kit)\***  
Set of four swivel ESD/Conductive 5" x 1-1/4" casters, two with brakes. Can be used with all units shown. Up to 1,200 lb. load capacity. \*Mobile kits recommended only for shelves 18" and deeper.



WR6-36-1236-102CO



WR12-108CO



# 11 SIZES AVAILABLE



## Conductive Dividable Grid Containers



Protect your electronic components from typical electromagnetic interference (EMI), electrostatic or induced fields with these molded, carbon-filled, copolymer polypropylene dividable grid containers. Surface resistivity is less than 10<sup>5</sup> Ohms-per square. The conductive material provides a barrier which these fields cannot penetrate and prevents the build-up of electrostatic charge. Containers, dividers and covers are permanently conductive and are unaffected by washing with normal cleaners. Containers have a load capacity of up to 100 lb. Dividers available to customize your box into compartments at 1-1/8" intervals and snap covers protect contents from dust or damage. Be sure all bins are properly grounded according to your use.

## Conductive Label Holders

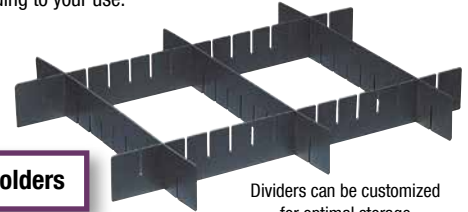

Dividers can be customized for optimal storage (Sold separately)

Available in: ● Black

MODEL NO.	DIMENSIONS H" x W"	FITS BIN MODEL NO.	CTN QTY
<b>LBL2X8CO</b>	2" x 8"	DG91025CO, DG91035CO, DG92035CO, DG93030CO	6
<b>LBL3X5CO</b>	3" x 5"	DG91050CO, DG92050CO, DG92060CO, DG93060CO	6
<b>LBL5X8CO</b>	5" x 8"	DG92080CO, DG93080CO, DG93120CO	6

Available in: ● Black

MODEL NO.	OUTSIDE DIMENSIONS L" x W" x H"	INSIDE DIMENSIONS L" x W" x H"	CTN QTY	CTN WGT	SHORT DIVIDER	CTN LONG DIVIDER	CTN LONG DIVIDER	CTN QTY COVER	CTN QTY
<b>Number of Dividers on Short Side: 5 / Long Side: 7</b>									
<b>DG91025CO</b>	10-7/8" x 8-1/4" x 2-1/2"	9-3/16" x 6-9/16" x 2"	20	16 lbs	<b>DS91025CO</b>	6	<b>DL91025CO</b>	6	<b>COV91000CO</b> 10
<b>DG91035CO</b>	10-7/8" x 8-1/4" x 3-1/2"	9-3/16" x 6-9/16" x 3"	20	24 lbs	<b>DS91035CO</b>	6	<b>DL91035CO</b>	6	<b>COV91000CO</b> 10
<b>DG91050CO</b>	10-7/8" x 8-1/4" x 5"	9-3/16" x 6-9/16" x 4-1/2"	20	32 lbs	<b>DS91050CO</b>	6	<b>DL91050CO</b>	6	<b>COV91000CO</b> 10
<b>Number of Dividers on Short Side: 7 / Long Side: 11</b>									
<b>DG92035CO</b>	16-1/2" x 10-7/8" x 3-1/2"	14-7/8" x 9-1/4" x 3"	12	23 lbs	<b>DS92035CO</b>	6	<b>DL92035CO</b>	6	<b>COV92000CO</b> 4
<b>DG92050CO</b>	16-1/2" x 10-7/8" x 5"	14-7/8" x 9-1/4" x 4-1/2"	12	25 lbs	<b>DS92050CO</b>	6	<b>DL92050CO</b>	6	<b>COV92000CO</b> 4
<b>DG92060CO</b>	16-1/2" x 10-7/8" x 6"	14-7/8" x 9-1/4" x 5-1/2"	8	20 lbs	<b>DS92060CO</b>	6	<b>DL92060CO</b>	6	<b>COV92000CO</b> 4
<b>DG92080CO</b>	16-1/2" x 10-7/8" x 8"	14-7/8" x 9-1/4" x 7-1/2"	8	27 lbs	<b>DS92080CO</b>	6	<b>DL92080CO</b>	6	<b>COV92000CO</b> 4
<b>Number of Dividers on Short Side: 11 / Long Side: 15</b>									
<b>DG93030CO</b>	22-1/2" x 17-1/2" x 3"	20-5/8" x 15-5/8" x 2-1/2"	6	20 lbs	<b>DS93030CO</b>	6	<b>DL93030CO</b>	6	<b>COV93000CO</b> 3
<b>DG93060CO</b>	22-1/2" x 17-1/2" x 6"	20-5/8" x 15-5/8" x 5-1/2"	3	16 lbs	<b>DS93060CO</b>	6	<b>DL93060CO</b>	6	<b>COV93000CO</b> 3
<b>DG93080CO</b>	22-1/2" x 17-1/2" x 8"	20-5/8" x 15-5/8" x 7-1/2"	3	19 lbs	<b>DS93080CO</b>	6	<b>DL93080CO</b>	6	<b>COV93000CO</b> 3
<b>DG93120CO</b>	22-1/2" x 17-1/2" x 12"	20-5/8" x 15-5/8" x 11-1/2"	3	23 lbs	<b>DS93120CO</b>	6	<b>DL93120CO</b>	6	<b>COV93000CO</b> 3



### DIVIDERS

Containers can be divided by length and/or width allowing a subdivision down to a 1-1/8" square compartment size. Available in Black.



### SNAP ON COVERS

Snap on covers protect contents from damage or dust during shipping and storage.



### LABEL HOLDERS

Fits any size container. Three sizes to choose from. Attach via metal grommets on label holder and bins.



BC212434M1CO

## COMPLETE PACKAGES WITH BINS

### Conductive Bin Carts

Offering two heights and four bin quantity designs, these modular carts are the ultimate work-in-process and transport carts. Dividable grids slide easily in and out and with their ability to be divided into multiple compartments with long and short dividers, truly any type of storage is possible. Dividable grids are available in Black. **Cart Finish:** Chrome

MODEL NO.	NO. OF BINS	BIN DIMENSIONS L" x W" x H"	SHIP WGT
<b>21"W x 24"L x 45"H - Bin Cart with Dividable Grid Containers</b>			
<b>BC212434M1CO</b>	4 DG93060CO	22-1/2" x 17-1/2" x 6"	58 lbs
<b>BC212439M2CO</b>	7 DG93030CO	22-1/2" x 17-1/2" x 3"	79 lbs
<b>21"W x 24"L x 69"H - Bin Cart with Dividable Grid Containers</b>			
<b>BC212469M1CO</b>	7 DG93060CO	22-1/2" x 17-1/2" x 6"	107 lbs
<b>BC212469M2CO</b>	11 DG93030CO	22-1/2" x 17-1/2" x 3"	111 lbs
<b>21"W x 24"L x 45"H - Bin Cart with No Dividable Grid Containers</b>			
<b>BC212439M4CO</b>	No Containers (Includes Slides for 4 Bin Levels)		46 lbs
<b>BC212439M7CO</b>	No Containers (Includes Slides for 7 Bin Levels)		55 lbs
<b>21"W x 24"L x 69"H - Bin Cart with No Dividable Grid Containers</b>			
<b>BC212469MCO</b>	No Containers (Includes Slides for 7 Bin Levels)		63 lbs
<b>BC212469M11CO</b>	No Containers (Includes Slides for 11 Bin Levels)		75 lbs



**LOWEST PRICE GUARANTEE**

### Conductive Wire Utility Carts

Carts consists of 2 u-handles, 4 donut bumpers, 4 conductive swivel casters (2 with brakes), drag chain and 2 or 3 wire shelves.

MODEL NO.	DIMENSIONS W" x L" x H"	SHIP WGT
<b>2 Wire Shelf Mobile Utility Carts</b>		
WRC-1836-2CO	18" x 36" x 37-1/2"	30 lbs
WRC-1842-2CO	18" x 42" x 37-1/2"	32 lbs
WRC-1848-2CO	18" x 48" x 37-1/2"	37 lbs
WRC-2436-2CO	24" x 36" x 37-1/2"	36 lbs
WRC-2442-2CO	24" x 42" x 37-1/2"	40 lbs
WRC-2448-2CO	24" x 48" x 37-1/2"	44 lbs
<b>3 Wire Shelf Mobile Utility Carts</b>		
WRC-1836-3CO	18" x 36" x 37-1/2"	37 lbs
WRC-1842-3CO	18" x 42" x 37-1/2"	42 lbs
WRC-1848-3CO	18" x 48" x 37-1/2"	48 lbs
WRC-2436-3CO	24" x 36" x 37-1/2"	49 lbs
WRC-2442-3CO	24" x 42" x 37-1/2"	55 lbs
WRC-2448-3CO	24" x 48" x 37-1/2"	60 lbs



WRC-1836-2CO

### ESD Modular Trays



18" x 26" and 20" x 26" trays are ESD and comply with ANSI/ESD standards for the use in PC board assembly and handling. All trays are manufactured of fiberglass reinforced theroset material, allowing up to 200 lb. weight capacity when evenly distributed. Quantum's modular trays will withstand temperatures of -40°F to +350°F. Trays are resistant to abrasion and chemicals. Trays are permanently conductive, properties are unaffected by washing in steam or water.

Available in: ● Black

MODEL NO.	DIMENSIONS W" x L" x H"	SHIP WGT
1826ESD	18" x 26" x 1-1/8"	4 lbs
2026ESD	20" x 26" x 1-1/2"	5 lbs

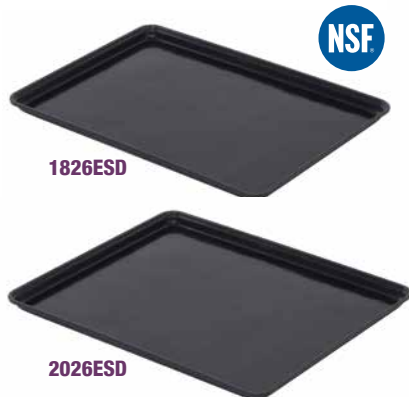

1826ESD

2026ESD

**Up to 200 lb. LOAD CAPACITY PER TRAY**

### Conductive Modular Tray Carts

Tray carts are offered in half size and full size units, designed to handle work in process. ESD trays can be used on tray cart for conductive applications with the addition of aluminum split sleeves (**ESD-SS**) or conductive plastic split sleeves (**WR-SSCO**) and a drag chain (**ESD-DC**). Optional Tray Stop prevents trays from falling out. **Cart finish:** Chrome



MODEL NO.	DIMENSIONS W" x L" x H"	SHIP WGT	NO. OF TRAYS	TRAY STOP MODEL NO.
<b>39" H - Side Load Tray Cart</b>				
TC-19CO	18" x 30" x 39"	45 lbs	19	TS32C
<b>69" H - Side Load Tray Carts</b>				
TC-20CO <b>NEW</b>	18" x 30" x 69"	72 lbs	20	TS62C
TC-39CO	18" x 30" x 69"	74 lbs	39	TS62C
TC-31CO	21" x 30" x 69"	68 lbs	31	TS62C
<b>69" H - End Load Tray Cart</b>				
TC-EL38CO	21-3/4" x 27" x 69"	74 lbs	38	TS62C

Trays are sold separately

**CONVERT STANDARD WIRE SHELVING INTO CONDUCTIVE SHELVING WITH THESE ACCESSORIES THAT ARE INCLUDED WITH THESE PACKAGES**



ESD-DC Drag Chain



WR-SSCO Plastic Conductive Split Sleeve

**TC-39CO + 1826ESD**  
Tray Stops **TS62C** can be used on back as shown here or one in the back and one in the front. (Trays sold separately)

**Portable Computer/LAN Work Center**

Portable Computer Center and mini LAN (*Local Area Network*) Work Center offers flexibility in any operation. The modular characteristics allow the unit to be adaptable to all your equipment requirements such as servers, PCs, printers, keyboards, and monitors. This system features adjustable shelves on 1" increments, quick field assembly without the use of tools, excellent strength, durable chrome finish and easy to roll locking 3" polyurethane casters. **Finish:** Chrome

- Unit consists of:*
- 4 - 34" posts
  - 3 - 24" x 30" wire shelves
  - 1 - keyboard tray
  - 1 - document holder basket
  - 4 - 3" poly stem casters



**M2430CLAN**  
(computer, monitor, keyboard, printer, folder not included)

**Conductive Accessories**



**WR-SSCO**  
Conductive Plastic  
Split Sleeves



**ESD-DC**  
Drag Chain

**Reel Shelving Units**



Quantum Reel Shelving offers a safe and efficient method of transporting and storing standard size component reels. New reel shelves are chrome plated and can be used in conjunction with same size standard flat wire shelves. Units are available with conductive accessories providing a static safe storage system to address reel handling and providing stationary or mobile complete storage systems for PCB manufacturers. **Finish:** Chrome



**WRC-R264C**  
(see pg. 121 for additional sizes)

**Up to 400 lb.**  
LOAD CAPACITY  
PER SHELF



**Up to 800 lb.**  
LOAD CAPACITY  
PER SHELF



**MOBILIZE YOUR SHELVING**

**DB - Donut Bumper**  
Non-marking donut bumper used to protect walls and help cushion impact.

**WR-00CO (Mobile Kit)\***  
Set of four swivel ESD/Conductive 5" x 1-1/4" casters, two with brakes. Can be used with all units shown. Up to 1,200 lb. load capacity. \*Mobile kits recommended only for shelves 18" and deeper.

**Stencil Unit**



Quantum's new stencil storage racks efficiently and safely store and transport dry stencils. Adjustable shelves and dividers accommodate all frames from 20" to 29" deep. Optional performance cushion ride conductive casters allow built in ESD/conductive protection. Optional side panels available. **Finish:** Chrome



**WR74-2436C-22D**  
24"W x 36"L x 74"H  
3 shelves and 22 DIV24 dividers

Clear Tip Out Bins



**THE ORIGINAL AND INDUSTRY STANDARD**

Space saving bin units keep small and medium sized parts organized, sorted and easy to find. These clear, break resistant injection molded plastic containers tip open smoothly to a 45° angle and are completely removable for easy access and refilling. Molded handle with slots for labels provided. Bins are easily cleaned with soap and water. Polystyrene cabinet can be stacked or wall mounted. Exterior available in 3 colors. Cups are clear. Optional dividers, locking rod and louvered panel bracket also available.

Available in: ● Ivory ● Gray ○ White

MODEL NO.	OUTSIDE DIMENSIONS L" x W" x H"	CUP DIMENSIONS L" x W" x H"	CTN QTY	CTN WGT
QTB301	11-3/4" x 11-13/16" x 13-7/8"	8-7/8" x 11-1/16" x 13-5/8"	1	7 lbs
QTB302	11-3/4" x 23-5/8" x 13-7/8"	8-7/8" x 11-1/16" x 13-5/8"	1	14 lbs
QTB303	7-3/4" x 23-5/8" x 9-1/2"	5-7/8" x 7-3/8" x 8-5/8"	1	9 lbs
QTB304	6-5/8" x 23-5/8" x 8-1/8"	5" x 5-5/8" x 7-1/2"	1	7 lbs
QTB305	5-1/4" x 23-5/8" x 6-1/2"	3-3/4" x 4-1/4" x 5-3/4"	1	5 lbs
QTB306	3-5/8" x 23-5/8" x 4-1/2"	2-5/8" x 3-1/2" x 3-3/4"	1	2 lbs
QTB309	2-1/2" x 23-5/8" x 3-1/8"	1-3/4" x 2-3/16" x 2-1/2"	1	2 lbs
DIV303	3 Dividers for QTB303		3	2 lbs
DIV304	4 Dividers for QTB304		4	1 lb
QLR500	Locking Rod for 23-5/8"W Tip Out Bins		1	1 lb
QTB-LP-BKT	Louvered Panel Bracket Pair for Tip Out Bins (Sold as a pair)		2	1 lb

**TIP OUT BIN CLEAR COMPARTMENTS KEEP SMALL ITEMS SORTED AND EASY TO FIND**



QTB309

QTB306

QTB305

QTB304

QTB303

QTB302



**QTB-LP-BKT**  
Louvered Panel Bracket  
Hang 23-5/8"W bin on louvered panel using bracket pair. Available in Beige or Gray. Panels available on [pg. 8](#).



**DIV303 and DIV304**  
QTB303 and QTB304 cup can use optional divider, as shown.



**QLR500**  
Locking Rod  
Keeps bins from tilting open. Can be used with 23-5/8"W bins.



QTB309



QTB306



QTB305



QTB304



QTB303



QTB302

**TIP OUT BIN**



QTB301

# CLEAR TIP OUT BIN SYSTEMS CAN BE USED IN ANY APPLICATION



## INDUSTRIAL, MECHANICAL AND PLUMBING SUPPLIES

Very handy for the garage, tool shed, service vehicle, factory, hardware and home center facilities.



## MEDICAL

Very efficient when it comes to organizing and keeping an effective inventory in hospitals, pharmacies, labs or clinics.



## PLAYROOM

The smartest organizer after a hard day's play. It will help keep your child's room in order.

### Individual Tip Out Bins



These unique bins have the ability to interlock horizontally or vertically. Available in three popular sizes, these bins allow you to create your own customized Tip Out Bin storage system perfect for color coding.

QTB405 and QTB406 available in: ● Ivory ● Gray ○ White  
QTB409 available in: ● Blue ● Red ● Yellow ○ White

MODEL NO.	OUTSIDE DIMENSIONS L" x W" x H"	CTN QTY	CTN WGT
QTB405	5-1/4" x 4-3/4" x 6-1/4"	5	6 lbs
QTB406	3-5/8" x 4-1/16" x 4-1/4"	6	4 lbs
QTB409	2-3/8" x 2-13/16" x 3"	9	3 lbs

To order a full carton add **CS** suffix to Model No. QTB405BLC**S**. **Note:** Bins must be ordered in carton quantities only.

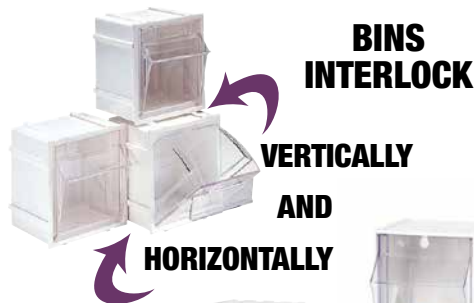

### BINS INTERLOCK

VERTICALLY

AND

HORIZONTALLY



QTB409



QTB406



QTB405

### Dividable Tip Out Bins



These bins feature removable and adjustable dividers so that the clear bin can be partitioned into smaller compartments. Ideal for larger or longer items, these clear Tip Out Bins are molded from the same strong and flexible material as our standard bins. The flexibility of bins allow the user to determine the size and volume of each storage compartment. Exterior available in 3 colors. Cups are clear.

Available in: ● Ivory ● Gray ○ White

MODEL NO.	OUTSIDE DIMENSIONS L" x W" x H"	CTN QTY	CTN WGT
QTB410	5-1/4" x 11-7/8" x 5-15/16"	1	3 lbs
DIV400	Divider for Dividable Tip Out Bins	4	1 lb

### PERFORMANCE FEATURES:

- Bins can be stacked as modular units or used individually
- Exterior housing is injection molded from high impact Polystyrene
- Clear bin cups are injection molded from a custom blend of Phillips K Resin and Crystal Styrene for clarity and durability
- Compartments tip open smoothly to a 45° angle and provide comfortable and complete access to stored items
- The flexibility of the system allows you to customize your own system to meet your specific needs



**QTB410**  
QTB410 is a one bin design, 12" wide  
Each QTB410 comes with 3 DIV400 clear dividers\*

\*Note: Dividers shown in white color for clarity

### 21 Compartment Tip Out Bin Set



TIP OUT BIN

- 21 clear cups inside one unit
- Clear cups with blue handles

Available in: ● Gray

MODEL NO.	OUTSIDE DIMENSIONS L" x W" x H"	CUP DIMENSIONS L" x W" x H"	CUP QTY	PKG QTY	PKG WGT
QTB669	3-5/8" x 23-5/8" x 11-1/6"	2-5/8" x 3-1/2" x 3-3/4" 1-3/4" x 2-3/16" x 2-1/2"	12 9	4	24 lbs



QTB669

### Clear Tip Out Bin Rails

Provide an easy and efficient way to build a high density expandable storage system. U-channel shaped rails allow Tip Out Bins to slide easily to any height. Each Tip Out Bin needs 2 disks and 2 screws (**QDS300**) in order to affix to all rails and frames. (Bins are sold separately). Powder coat finish.

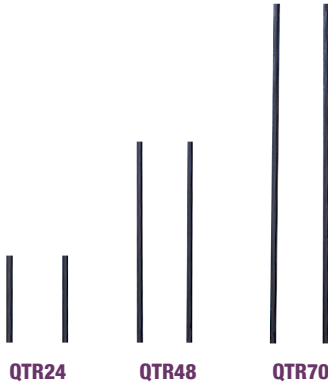

Utilize rails when base of the first bin will sit on the floor

**TIP OUT**  
TIP OUT  
TIP OUT  
TIP OUT  
TIP OUT

Available in: ● Black

MODEL NO.	DESCRIPTION	CTN QTY	CTN WGT	NO. OF BINS TO FIT EACH FRAME					
				QTB 302	QTB 303	QTB 304	QTB 305	QTB 306	QTB 309
<b>QTR24</b>	Two 24"H Rails	1 Set	2 lbs	1	2	3	3	5	8
<b>QTR48</b>	Two 48"H Rails	1 Set	4 lbs	3	5	6	7	10	16
<b>QTR70</b>	Two 70"H Rails	1 Set	5 lbs	5	7	8	10	15	23

### Clear Tip Out Bin Frames

Frames are manufactured with preset parallel distance allowing Tip Out Bins to be stacked and removed easily and efficiently. All frames have a ledge at the bottom allowing Tip Out Bins to be secured above ground level. Each Tip Out Bin needs 2 disks and 2 screws (**QDS300**) in order to affix to all rails and frames. (Bins are sold separately). Powder coat finish.

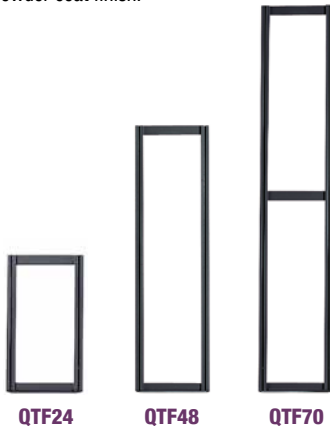

Utilize frame when bins will be mounted above floor level



Available in: ● Black

MODEL NO.	DESCRIPTION	CTN QTY	CTN WGT	NO. OF BINS TO FIT EACH FRAME					
				QTB 302	QTB 303	QTB 304	QTB 305	QTB 306	QTB 309
<b>QTF24</b>	24"H Frame	1	3 lbs	1	2	3	3	5	8
<b>QTF48</b>	48"H Frame	1	5 lbs	3	5	6	7	10	16
<b>QTF70</b>	70"H Frame	1	7 lbs	5	7	8	10	15	23

## HOW TIP OUT BINS AFFIX TO RAILS AND FRAMES

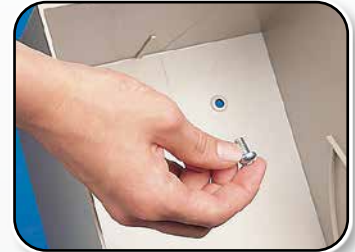

**1** Having removed transparent clear cups, insert screw corresponding to screw holes in Tip Out Bin housing.



**2** Insert screws and screw into disk on back of Tip Out Bin housing.



**3** Insert disk into frame rails.



**4** Once in place, tighten screws to affix Tip Out Bin to frame rails.

**Clear Tip Out Bin Floor Stands - Single, Double and Mobile**  
Clearly your best storage solution

Nine pre-configured systems available as pictured allowing you to purchase your Tip Out system exactly as shown here. The flexibility of the system also allows you to customize and create your own configurations (see chart for all possibilities). All steel systems are formed from heavy-duty 14 gauge steel and have a powder coat finish ensuring years of use. Three different heights to choose from: 24", 48" or 70". Systems are single sided, double sided or double sided mobile. Tip Out Bins are available in 3 exterior colors. See pg. 91 for bin dimensions.

**SINGLE SIDED**  
**Up to 300 lb.**  
**LOAD CAPACITY**



**QFS124-31**  
1 QTB304  
3 QTB306  
1 QTB309

**QFS148-38**  
1 QTB302  
1 QTB303  
1 QTB304  
1 QTB305  
1 QTB306  
2 QTB309



**QFS170-36**  
4 QTB303  
2 QTB304  
2 QTB305  
1 QTB306



**TIP OUT**  
**OUT**  
**OUT**  
**OUT**  
**BIN**

**COMPLETE PACKAGES**  
**WITH BINS**

**DOUBLE SIDED**  
**Up to 600 lb.**  
**LOAD CAPACITY**



**QFS224-24**  
2 QTB303  
2 QTB304  
2 QTB305

**QFS248-76**  
2 QTB302  
2 QTB303  
2 QTB304  
2 QTB305  
2 QTB306  
4 QTB309



**QFS270-72**  
8 QTB303  
4 QTB304  
4 QTB305  
2 QTB306



**CREATE YOUR OWN  
CUSTOM CONFIGURATION**

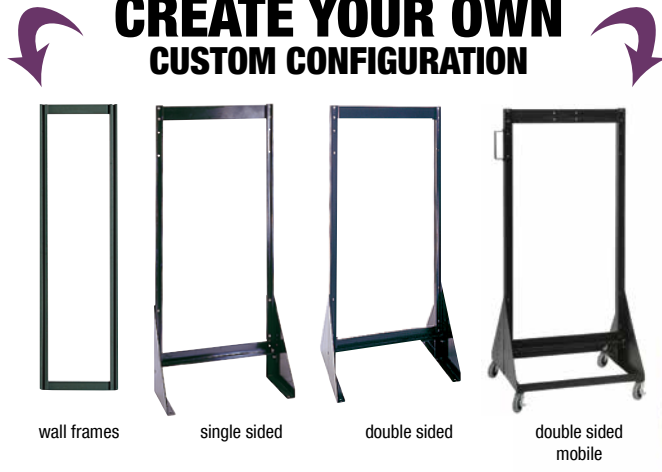

Mobile Clear Tip Out Bin Floor Stands

**COMPLETE PACKAGES  
WITH BINS**

**QFS224-24  
+ QFS400**  
2 QTB303  
2 QTB304  
2 QTB305



**TIP OUT  
TIP OUT  
TIP OUT  
BIN**

**QFS270-72  
+ QFS400**  
8 QTB303  
4 QTB304  
4 QTB305  
2 QTB306



**QFS248-76  
+ QFS400**  
2 QTB302  
2 QTB303  
2 QTB304  
2 QTB305  
2 QTB306  
4 QTB309

**MOBILE  
Up to 500 lb.  
LOAD CAPACITY**

Bins available in: ● Ivory ● Gray ○ White

MODEL NO.	DESCRIPTION	DIMENSIONS D" x W" x H"	CTN WGT	QTY. OF BINS TO FIT SYSTEM									
				QTB 302	QTB 303	QTB 304	QTB 305	QTB 306	QTB 309				
<b>Floor Stands - Single Sided (Disks and Screws Required)</b>													
QFS124	24"H Single Sided (Workstation)	10" x 23-5/8" x 28"	11 lbs	1	2	3	3	5	8				
QFS148	48"H Single Sided	10" x 23-5/8" x 52"	19 lbs	3	5	6	7	11	16				
QFS170	70"H Single Sided	10" x 23-5/8" x 75"	20 lbs	5	7	8	10	15	23				
<b>Floor Stands - Double Sided (Disks and Screws Required)</b>													
QFS224	24"H Double Sided (Workstation)	20-1/4" x 23-5/8" x 28"	21 lbs	2	4	6	6	10	16				
QFS248	48"H Double Sided	20-1/4" x 23-5/8" x 52"	36 lbs	6	10	12	14	22	32				
QFS270	70"H Double Sided	20-1/4" x 23-5/8" x 75"	42 lbs	10	14	16	20	30	46				
<b>Mobile Kit (Includes four casters and one handle)</b>													
QFS400*	Mobile Kit for Double Sided Systems		9 lbs	-	-	-	-	-	-				
<b>Disks and Screws</b>													
QDS300	2 Disks and 2 Screws (1 set)		1 lb	-	-	-	-	-	-				

(Tip Out Bins sold separately) 1 set of disks and screws are required per Tip Out Bin system \*All mobile units come with four 3" polyurethane casters(all with brakes)

**Free Standing Slider Systems**  
 - Complete Packages

Sliders feature four individual panels filled with tip out bins. Two are fixed to the back side of the system and two slide easily from left to right allowing free access to all four panels. Manufactured of tough 14 gauge steel with a baked enamel finish, the overall unit measures 18"D x 48"W x 77"H or 26"D x 51"W x 77"H. Heavy-duty up to 2,000 lb. capacity. Bins are available in 3 exterior colors.

Bins available in: ● Ivory ● Gray ● White

MODEL NO.	NO. OF BINS	NO. OF BIN CUPS
QS-304-28	28 QTB304	112
QS-305-36	36 QTB305	180
QS-306-56	56 QTB306	336
QS-309-80	80 QTB309	720
QS-305306-52	9 QTB305, 43 QTB306	303
QS-569-56	8 QTB305, 36 QTB306, 12 QTB309	364
QS-BIG-101	3 QTB302, 8 QTB303, 14 QTB304, 3 QTB305	101
QS-000	Free Standing Slider Only - NO BINS	-

\*All necessary hardware included with all systems

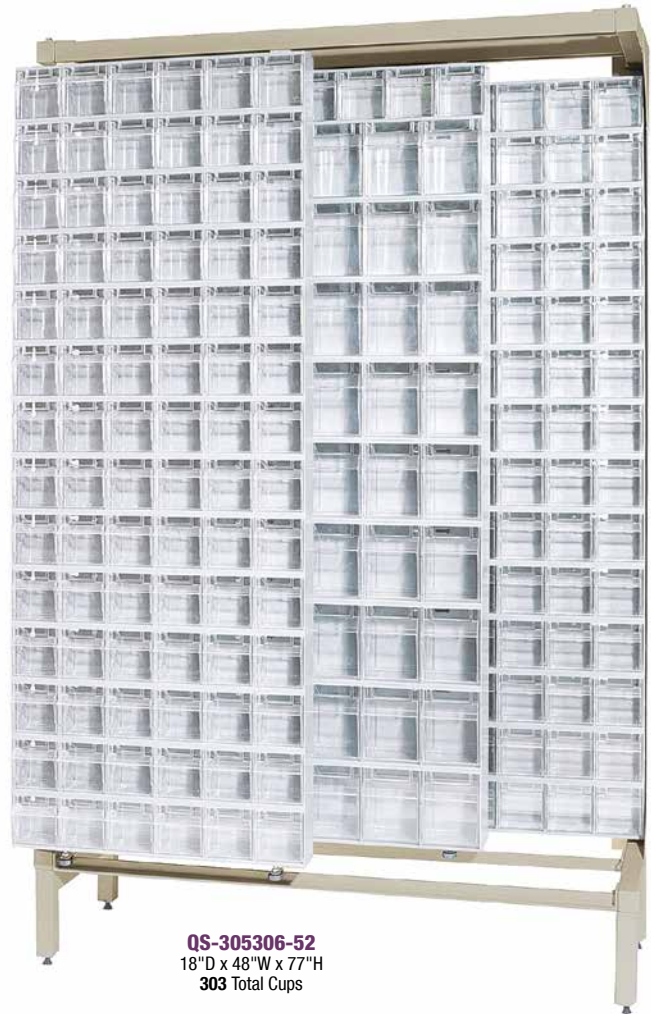

**QS-305306-52**  
 18"D x 48"W x 77"H  
 303 Total Cups

**CONVERT 8' OF STORAGE SPACE INTO JUST 4'**

**TIP OUT BIN**

**Up to 2,000 lb. LOAD CAPACITY**



**QS-569-56**  
 18"D x 48"W x 77"H  
 364 Total Cups



**QS-BIG-101**  
 26"D x 51-1/4"W x 77"H  
 To be used with QTB302 and QTB303  
 101 Total Cups

**Gondola Slider Systems  
- Complete Packages**

Gondola systems provide the same versatility for orderly and efficient storage solutions in merchandising, inventory control and storing of small to medium sized parts. Metal slider systems affix heavy-duty up to 2,000 lb. capacity to most standard gondolas.

Units available for purchase in the following three ways:

- Slider Frame Only (*designed for fast installation on your existing 72"H Gondola*). **QS-725**
- Slider Frame with Gondola (*no Tip Out Bins*) Overall Dimensions 19"D x 48"W x 75"H. **G-725**
- Slider Frame filled with Tip Out Bins with Gondola - *Complete Package* (five available combinations, see chart below).

Bins available in: ● Ivory ● Gray ○ White

MODEL NO.	NO. OF BINS	NO. OF BIN CUPS
<b>QS-725</b>	Slider Frame Only	-
<b>G-725</b>	Gondola with Slider Frame	-
<b>G-725304-28</b>	28 QTB304	112
<b>G-725305-36</b>	36 QTB305	180
<b>G-725306-56</b>	56 QTB306	336
<b>G-725309-80</b>	80 QTB309	720
<b>G-725569-56</b>	8 QTB305, 36 QTB306, 12 QTB309	364

\*All necessary hardware included with all systems

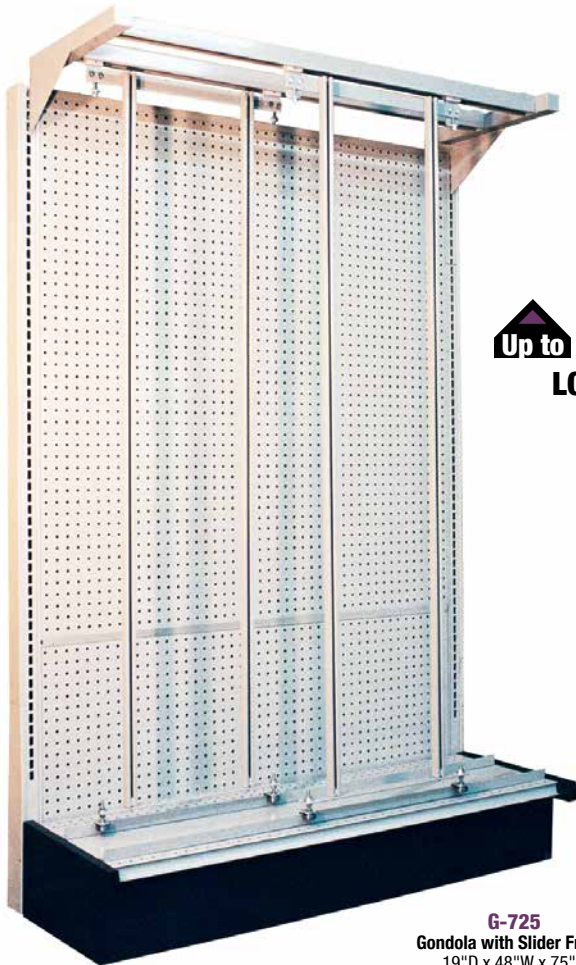

**G-725**  
Gondola with Slider Frame  
19"D x 48"W x 75"H

**Up to 2,000 lb.**  
LOAD CAPACITY

**TIP OUT BIN**

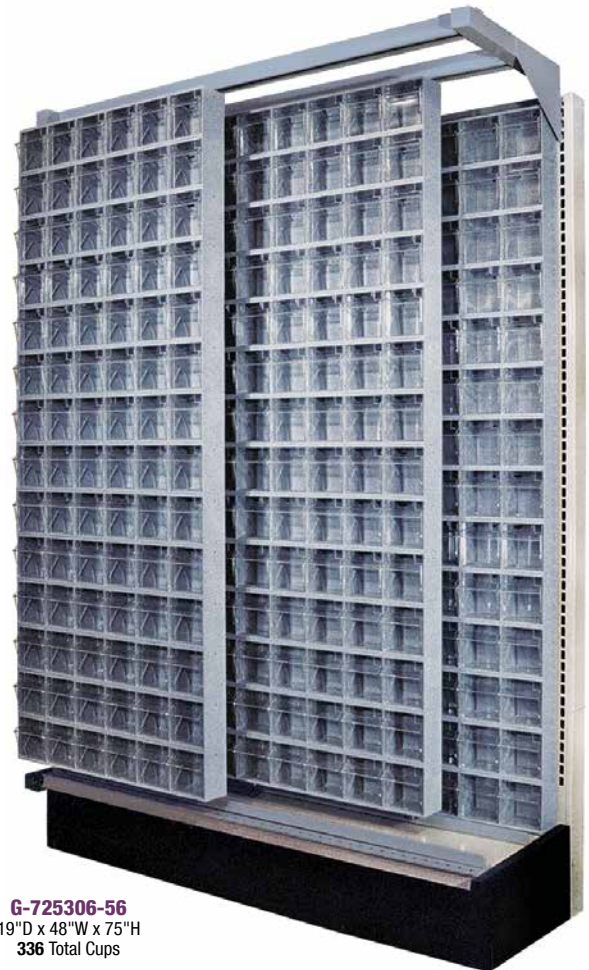

**G-725306-56**  
19"D x 48"W x 75"H  
336 Total Cups

**Interlocking Storage Cabinets**



Organize and store your small parts with these modular storage cabinets. Quantum's interlocking storage cabinets have the unique ability to interlock horizontally and vertically allowing you to customize your storage needs and maximize your storage space. Pre-drilled holes on the rear of cabinet allow for wall mounting. Cabinets are made from high impact polystyrene. Drawers are removable and will not rust or corrode. Drawers have a recessed handle and come with a slotted label holder. Drawers have seven divider slots molded-in so that they may be divided into multiple compartments. Clear window allows easy identification of parts. Nine pre-configured interlocking storage cabinet systems come complete with drawers, clear windows and two dividers per drawer. Additional dividers may be purchased separately. Exterior cabinets are available in Gray only.

Cabinets have the unique ability to interlock horizontally and vertically allowing you to customize your storage needs and maximize your storage space.



Cabinets available in: ● Gray  
 Drawers available in: ● Blue ● Red ● Ivory ● Gray

MODEL NO.	DRAWERS PER CABINET	CTN QTY	CTN WGT
<b>QIC-161</b>	16 IDR201	1	10 lbs
<b>QIC-122</b>	12 IDR202	1	10 lbs
<b>QIC-83</b>	8 IDR203	1	9 lbs
<b>QIC-64</b>	6 IDR204	1	9 lbs
<b>QIC-8143</b>	8 IDR201, 4 IDR203	1	10 lbs
<b>QIC-12123</b>	12 IDR201, 2 IDR203	1	10 lbs
<b>QIC-4163</b>	4 IDR201, 6 IDR203	1	10 lbs
<b>QIC-8224</b>	8 IDR202, 2 IDR204	1	10 lbs
<b>QIC-4244</b>	4 IDR202, 4 IDR204	1	10 lbs



**CABINET SYSTEMS COME COMPLETE WITH DRAWERS, CLEAR WINDOWS AND TWO DIVIDERS PER DRAWER**

**QIC-161**  
 All units measure overall 11-3/8"D x 11-3/4"W x 11"H  
 System comes with **16 IDR201**.  
 Available with Gray Cabinet and your choice of Gray, Blue, Red and Ivory for drawers.



**QIC-122**



**QIC-83**



**QIC-64**



**QIC-8143**



**QIC-12123**



**QIC-4163**



**QIC-8224**



**QIC-4244**

**COLOR CODE YOUR SMALL PARTS**

**Cabinet Drawers**

Additional drawers may be purchased separately. All drawers come complete with a clear window and two dividers. Additional dividers may be purchased separately.

Available in: ● Blue ● Red ● Ivory ● Gray



MODEL NO.	DIMENSIONS L" x W" x H"	CTN QTY	CTN WGT	DIVIDER	CTN QTY	CTN WGT
<b>IDR201</b>	11" x 2-3/4" x 2-1/2"	24	9 lbs	<b>DIV201</b>	25	1 lb
<b>IDR202</b>	11" x 2-3/4" x 3-5/16"	24	12 lbs	<b>DIV202</b>	25	1 lb
<b>IDR203</b>	11" x 5-5/8" x 2-1/2"	24	14 lbs	<b>DIV203</b>	25	1 lb
<b>IDR204</b>	11" x 5-5/8" x 3-5/16"	24	22 lbs	<b>DIV204</b>	25	2 lbs

# COMPLETE PACKAGES WITH BINS

## Interlocking Storage Cabinet Floor Stands - Single, Double and Mobile

24 pre-configured systems provide an assortment of storage solutions to meet every need. All steel systems are formed from heavy-duty 14 gauge steel and have a smooth powder coat finish ensuring years of use. Three different heights to choose from: 24", 48" or 70". Units are single sided or double sided. Double-sided systems can be made mobile with the addition of the **QFS-400 (mobile kit)** four 3" polyurethane casters all with brakes and up to 500 lb. capacity. All single sided and double sided systems must be securely fastened to the floor to ensure stability. Interlocking storage cabinet systems come complete with drawers, clear windows and two dividers per drawer. Exterior cabinets are available in Gray only.



**QIC-270-161**



**QIC-124-83**



**QIC-248-122 + QFS-400**

All mobile units come with four 3" polyurethane casters, all with brakes and up to 500 lb. capacity

**384**  
drawers

**192**  
drawers

**32**  
drawers

### HIGH DENSITY STORAGE

Cabinets available in: ● Gray    Drawers available in: ● Blue ● Red ● Ivory ● Gray

#### COMPLETE STORAGE CABINET FLOOR STANDS

SINGLE SIDED - UP TO 300 LB. LOAD CAPACITY				DOUBLE SIDED - UP TO 750 LB. LOAD CAPACITY			
MODEL NO.	CABINET PER FLOOR STAND	NO. OF DRAWERS	SHIP WGT	MODEL NO.	CABINET PER FLOOR STAND	NO. OF DRAWERS	SHIP WGT
<b>24"H - Single Sided Floor Stands</b>				<b>24"H - Double Sided Floor Stands</b>			
<b>QIC-124-161</b>	4 QIC-161	64	52 lbs	<b>QIC-224-161</b>	8 QIC-161	128	102 lbs
<b>QIC-124-122</b>	4 QIC-122	48	52 lbs	<b>QIC-224-122</b>	8 QIC-122	96	102 lbs
<b>QIC-124-83</b>	4 QIC-83	32	48 lbs	<b>QIC-224-83</b>	8 QIC-83	64	94 lbs
<b>QIC-124-64</b>	4 QIC-64	24	48 lbs	<b>QIC-224-64</b>	8 QIC-64	48	94 lbs
<b>48"H - Single Sided Floor Stands</b>				<b>48"H - Double Sided Floor Stands</b>			
<b>QIC-148-161</b>	8 QIC-161	128	100 lbs	<b>QIC-248-161</b>	16 QIC-161	256	196 lbs
<b>QIC-148-122</b>	8 QIC-122	96	100 lbs	<b>QIC-248-122</b>	16 QIC-122	192	196 lbs
<b>QIC-148-83</b>	8 QIC-83	64	92 lbs	<b>QIC-248-83</b>	16 QIC-83	128	180 lbs
<b>QIC-148-64</b>	8 QIC-64	48	92 lbs	<b>QIC-248-64</b>	16 QIC-64	96	180 lbs
<b>70"H - Single Sided Floor Stands</b>				<b>70"H - Double Sided Floor Stands</b>			
<b>QIC-170-161</b>	12 QIC-161	192	140 lbs	<b>QIC-270-161</b>	24 QIC-161	384	282 lbs
<b>QIC-170-122</b>	12 QIC-122	144	140 lbs	<b>QIC-270-122</b>	24 QIC-122	288	282 lbs
<b>QIC-170-83</b>	12 QIC-83	96	129 lbs	<b>QIC-270-83</b>	24 QIC-83	192	258 lbs
<b>QIC-170-64</b>	12 QIC-64	72	129 lbs	<b>QIC-270-64</b>	24 QIC-64	144	258 lbs

**QFS-400** Kit for mobilizing double sided systems. Includes casters and handle. Up to 500 lb. mobile load capacity.

AVAILABLE IN 8 FINISHES AND 3 LIMITED WARRANTIES



**Chrome** - is a plating process which deposits hard chrome over a copper, nickel surface. This process is very durable and allows product to be used in any application in a dry storage environment. **1 year limited warranty to not rust or corrode when used in dry and non-humid environments.**

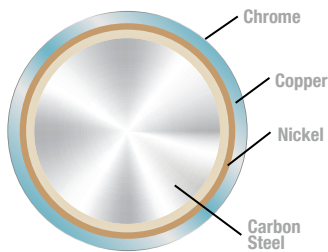

**Galvanized Steel** - is a manufacturing process where a coating of zinc is applied to steel to offer protection and prevent rusting. The zinc protects the base metal by acting as a barrier to corrosive elements. **1 year limited warranty to not rust or corrode when used in dry and non-humid environments.**

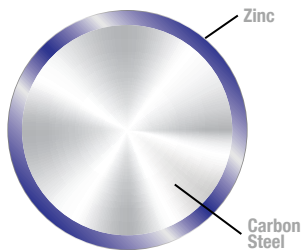

**Proform Green, Gray and Black Epoxy** - are an ideal solution for high humidity, wet, or walk-in-cooler applications. The carbon steel is treated with an iron phosphate and the powder coated epoxy is electrostatically applied, baked and cured to a hard surface. All three colors are antimicrobial. **15 year limited warranty for antimicrobial finish to not rust or corrode.**

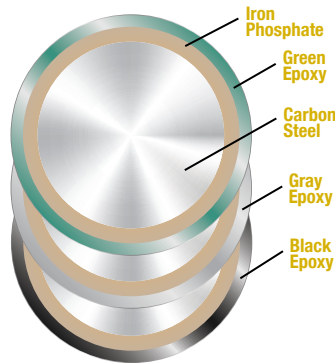

**Proform Green Polymer** - is an ideal solution for high humidity, wet, or walk-in-cooler applications. The carbon steel is treated with an iron phosphate and the powder coated epoxy is electrostatically applied, baked and cured to a hard surface. All three colors are antimicrobial. Plastic mats are virgin grade Polypropylene. **15 year limited warranty for antimicrobial finish to not rust or corrode. Limited lifetime on polymer shelf mats.**

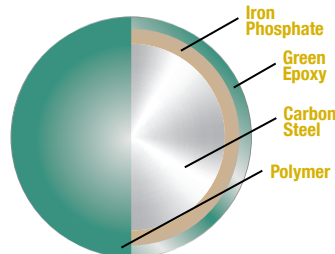

**Stainless Steel** - 304 Stainless with an electro-polish finish represents the highest industry standard in the prevention of corrosion. This finish is highly effective for corrosive, high humidity or clean room environments. **Lifetime limited warranty for 304 stainless steel electro-polish finish to not rust or corrode.**

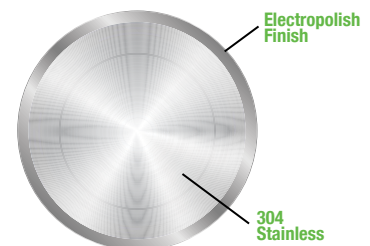

**Millenia Polymer** - all polymer, the best industry standard in the prevention of corrosion. This finish is highly effective for corrosive, high humidity or clean room environments. **Lifetime limited warranty to not rust or corrode.**

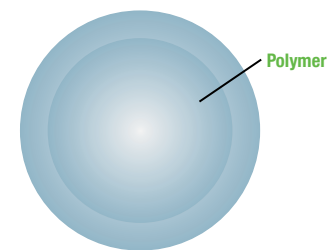

APPLICATION	CHROME & GALVANIZED FINISH	PROFORM GREEN, GRAY & BLACK EPOXY FINISH	PROFORM GREEN POLYMER FINISH	STAINLESS STEEL FINISH	ALL POLYMER FINISH
DRY STORAGE	YES	YES	YES	YES	YES
WET STORAGE	NO	YES	YES	YES	YES
COOLER STORAGE	NO	YES	YES	YES	YES
FREEZER STORAGE	NO	YES	YES	YES	YES
WARRANTY*	1 YEAR DRY	15 YEAR	15 YEAR WIRE/LIFETIME MATS	LIFETIME	LIFETIME

\*Limited against rust and corrosion

## MILLENNIA

Most innovative, all polymer shelving system

▶ Vented Shelf

▶ Solid Shelf



## PREMIUM

Exceptional hybrid shelving

▶ Vented Polymer

▶ Solid Polymer

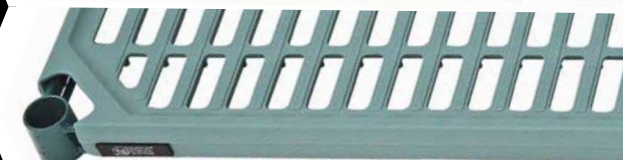

## CLASSICS PLUS

Most economical, corrosion resistant shelving

▶ Green Epoxy

▶ Gray Epoxy

▶ Black Epoxy



## CLASSICS

Original wire and solid storage shelving

▶ Stainless

▶ Solid Stainless

▶ Chrome

▶ Solid Galvanized

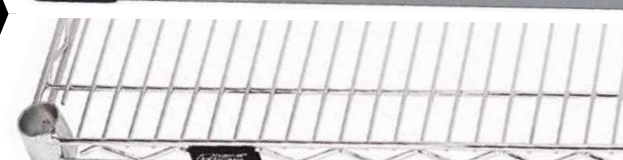
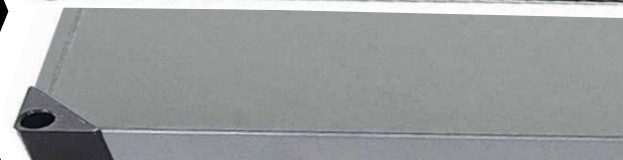

**QUANTUM CLASSICS**  
Chrome Wire Shelving

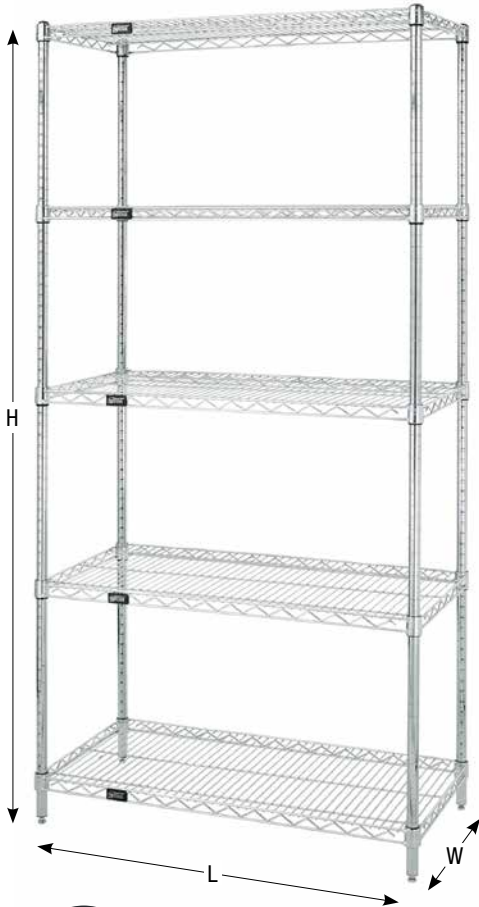

CHROME

**QUANTUM CLASSICS**  
Stainless Wire Shelving



STAINLESS

**QUANTUM CLASSICS**  
Solid Shelving



GALVANIZED



STAINLESS

**CHROME WIRE SHELVING**

- 1 year limited warranty
- Up to 800 lb. load capacity per shelf
- Wire allows air to circulate and light to penetrate for increased product visibility and minimal dust buildup
- NSF Approved
- Chrome finish

WIDTHS (W): 12", 14", 18", 21", 24", 30", 36"  
LENGTHS (L): 24", 30", 36", 42", 48", 54", 60", 66", 72"  
HEIGHTS (H): 6", 14", 34", 36", 39", 54", 63", 74", 86", 96"

**STAINLESS STEEL WIRE SHELVING**

- Lifetime limited warranty
- Up to 800 lb. load capacity per shelf
- Smooth, vented, open grid surface allows for air circulation and minimal dust buildup
- NSF Approved
- Antimicrobial
- 100% rust proof

WIDTHS (W): 12", 14", 18", 21", 24", 30", 36"  
LENGTHS (L): 24", 30", 36", 42", 48", 54", 60", 72"  
HEIGHTS (H): 6", 14", 34", 42", 54", 63", 74", 86", 96"

**SOLID SHELVING SYSTEM**

- 1 year limited warranty on Galvanized, Lifetime limited warranty on Stainless
- Up to 600 lb. load capacity per shelf
- NSF Approved
- Stainless Steel finish is antimicrobial and 100% rust proof

WIDTHS (W): 14", 18", 21", 24"  
LENGTHS (L): 24", 30", 36", 42", 48", 54", 60", 72"  
HEIGHTS (H): 6", 14", 34", 38", 39", 42", 54", 63", 74", 86", 96"

**QUANTUM CLASSICS PLUS**  
Epoxy Wire Shelving



**CORROSION RESISTANT EPOXY  
COATED WIRE SHELVING**

- 15 year limited warranty
- Up to 800 lb. load capacity per shelf
- Wire allows air to circulate and light to penetrate for increased product visibility and minimal dust buildup
- NSF Approved
- Antimicrobial
- Resistant against corrosion

**WIDTHS (W):** 12", 14", 18", 21", 24", 30", 36"  
**LENGTHS (L):** 24", 30", 36", 42", 48", 54", 60", 66", 72"  
**HEIGHTS (H):** 6", 14", 34", 39"(Only Black), 54", 63", 74", 86", 96"

**QUANTUM PREMIUM**  
Polymer Wire Shelving



**HYBRID POLYMER AND WIRE  
SHELVING**

- 15 year limited warranty on Epoxy, Lifetime limited warranty on Polymer
- Up to 800 lb. load capacity per shelf
- Smooth, vented, open grid surface allows for air circulation and minimal dust buildup
- Easily removable and dishwasher safe shelf plates
- NSF Approved
- Antimicrobial
- Resistant against corrosion

**WIDTHS (W):** 14", 18", 21", 24"  
**LENGTHS (L):** 24", 30", 36", 42", 48", 54", 60", 72"  
**HEIGHTS (H):** 6", 14", 34", 54", 63", 74", 86", 96"

**MILLENNIA**  
Polymer Shelving



**ALL POLYMER SHELVING  
SYSTEM**

- Lifetime limited warranty
- Up to 1000 lb. load capacity per shelf
- Smooth or vented, open grid surface allows for air circulation and minimal dust buildup
- Easily removable and dishwasher safe shelf plates
- NSF Approved
- 100% rust proof
- All Polymer

**WIDTHS (W):** 18", 21", 24"  
**LENGTHS (L):** 24", 30", 36", 42", 48", 54", 60", 72"  
**HEIGHTS (H):** 14", 26", 38", 50", 62", 74", 86", 98"



Wire Shelves



Genuine Quantum modular wire systems offer a unique combination of shelf and post sizes in a variety of finishes to work in any application. The all welded shelf construction is supported with architectural wire trusses to provide between up to 600 lb. and 1,000 lb. capacity per shelf.



Up to **600-800 lb.**  
LOAD CAPACITY  
PER SHELF

Up to **1,000 lb.**  
LOAD CAPACITY PER  
HEAVY-DUTY SHELF (HD Models)



CHROME

304 STAINLESS STEEL

PROFORM GREEN EPOXY

GRAY EPOXY

BLACK EPOXY

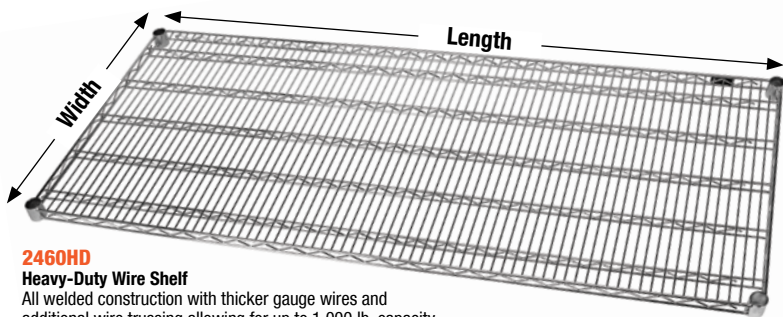

**2460HD**  
Heavy-Duty Wire Shelf

All welded construction with thicker gauge wires and additional wire trussing allowing for up to 1,000 lb. capacity

**PERFORMANCE FEATURES:**

- All welded construction with additional wire trussing for high strength characteristics
- Top mat wires run front to back (except on 12" x 36" size) for ease of loading and unloading and superior strength
- Wire allows air to circulate and light to penetrate for increased product visibility
- Minimal dirt accumulation
- Split sleeve connectors secure shelf corners to posts
- Numbered grooved posts on 1 inch increments for quick assembly
- No tools required for assembly
- Adjustable foot levelers allow for perfect stability
- Durable finishes
- Aesthetically pleasing
- Optional accessories (see pgs. 163-166)
- National Sanitation Foundation (NSF) Approved
- Shipped KD Class 70
- Up to 600 and 1,000 lb. capacity per shelf

SHELF W" x L"	SHIP WGT	CHROME	STAINLESS STEEL	EPOXY		
		MODEL NO.	MODEL NO.	PROFORM GREEN MODEL NO.	GRAY MODEL NO.	BLACK MODEL NO.
<b>12" Deep - Wire Shelves</b>						
12" x 24"	6 lbs	1224C	-	1224P	1224GY	1224BK
12" x 30"	6 lbs	1230C	-	1230P	1230GY	1230BK
12" x 36"	7 lbs	1236C	1236S	1236P	1236GY	1236BK
12" x 42"	8 lbs	1242C	-	1242P	1242GY	1242BK
12" x 48"	9 lbs	1248C	1248S	1248P	1248GY	1248BK
12" x 60"	14 lbs	1260C	1260S	1260P	1260GY	1260BK
12" x 72"	17 lbs	1272C	1272S	1272P	1272GY	1272BK
<b>14" Deep - Wire Shelves</b>						
14" x 24"	6 lbs	1424C	-	1424P	1424GY	1424BK
14" x 30"	7 lbs	1430C	1430S	1430P	1430GY	1430BK
14" x 36"	8 lbs	1436C	1436S	1436P	1436GY	1436BK
14" x 42"	10 lbs	1442C	1442S	1442P	1442GY	1442BK
14" x 48"	11 lbs	1448C	1448S	1448P	1448GY	1448BK
14" x 54"	12 lbs	1454C	1454S	1454P	1454GY	1454BK
14" x 60"	14 lbs	1460C	1460S	1460P	1460GY	1460BK
14" x 72"	17 lbs	1472C	1472S	1472P	1472GY	1472BK
<b>18" Deep - Wire Shelves</b>						
18" x 24"	7 lbs	1824C	1824S	1824P	1824GY	1824BK
18" x 30"	8 lbs	1830C	1830S	1830P	1830GY	1830BK
18" x 36"	10 lbs	1836C	1836S	1836P	1836GY	1836BK
18" x 42"	11 lbs	1842C	1842S	1842P	1842GY	1842BK
18" x 48"	14 lbs	1848C	1848S	1848P	1848GY	1848BK
18" x 54"	15 lbs	1854C	1854S	1854P	1854GY	1854BK
18" x 60"	17 lbs	1860C	1860S	1860P	1860GY	1860BK
18" x 72"	20 lbs	1872C	1872S	1872P	1872GY	1872BK
<b>21" Deep - Wire Shelves</b>						
21" x 24"	8 lbs	2124C	2124S	2124P	2124GY	2124BK
21" x 30"	9 lbs	2130C	2130S	2130P	2130GY	2130BK
21" x 36"	11 lbs	2136C	2136S	2136P	2136GY	2136BK
21" x 42"	12 lbs	2142C	2142S	2142P	2142GY	2142BK
21" x 48"	14 lbs	2148C	2148S	2148P	2148GY	2148BK
21" x 54"	16 lbs	2154C	2154S	2154P	2154GY	2154BK
21" x 60"	18 lbs	2160C	2160S	2160P	2160GY	2160BK
21" x 72"	24 lbs	2172C	2172S	2172P	2172GY	2172BK
<b>24" Deep - Wire Shelves</b>						
24" x 24"	9 lbs	2424C	2424S	2424P	2424GY	2424BK
24" x 30"	11 lbs	2430C	2430S	2430P	2430GY	2430BK
24" x 36"	13 lbs	2436C	2436S	2436P	2436GY	2436BK
24" x 42"	15 lbs	2442C	2442S	2442P	2442GY	2442BK
24" x 48"	16 lbs	2448C	2448S	2448P	2448GY	2448BK
24" x 54"	18 lbs	2454C	2454S	2454P	2454GY	2454BK
24" x 60"	20 lbs	2460C	2460S	2460P	2460GY	2460BK
24" x 66"	23 lbs	2466C	-	2466P	2466GY	-
24" x 72"	25 lbs	2472C	2472S	2472P	2472GY	2472BK
<b>24" Deep Heavy-Duty - Wire Shelves (Up To 1,000 lb. Capacity)</b>						
24" x 60"	25 lbs	2460CHD	-	-	-	-
24" x 72"	30 lbs	2472CHD	-	-	-	-
<b>30" Deep - Wire Shelves</b>						
30" x 30"	12 lbs	-	-	-	3030GY	-
30" x 36"	15 lbs	3036C	3036S	3036P	3036GY	3036BK
30" x 42"	18 lbs	3042C	3042S	3042P	3042GY	3042BK
30" x 48"	21 lbs	3048C	3048S	3048P	3048GY	3048BK
30" x 60"	27 lbs	3060C	3060S	3060P	3060GY	3060BK
30" x 72"	31 lbs	3072C	3072S	3072P	3072GY	3072BK
<b>36" Deep - Wire Shelves</b>						
36" x 36"	18 lbs	3636C	3636S	3636P	3636GY	3636BK
36" x 48"	23 lbs	3648C	3648S	3648P	3648GY	3648BK
36" x 60"	29 lbs	3660C	3660S	3660P	3660GY	3660BK
36" x 72"	35 lbs	3672C	3672S	3672P	3672GY	3672BK

**Posts**



All posts are fabricated from 16 gauge carbon steel with location grooves on one inch increments and ease for shelf installation. Numbers are printed between grooves for quick assembly. Posts are double grooved in consistent intervals for quick identification. Leveling legs are enclosed with all posts. Leveling legs cannot be used in conjunction with stem casters. Custom post heights are available, call for additional information.

DESCRIPTION	SHIP WGT	CHROME	STAINLESS STEEL	EPOXY		
		MODEL NO.	MODEL NO.	PROFORM GREEN	GRAY	BLACK
6"H Post	1 lb	<b>P6C</b>	<b>P6S</b>	<b>P6P</b>	<b>P6GY</b>	<b>P6BK</b>
14"H Post	2 lbs	<b>P14C</b>	<b>P14S</b>	<b>P14P</b>	<b>P14GY</b>	<b>P14BK</b>
34"H Post	2 lbs	<b>P34C</b>	<b>P34S</b>	<b>P34P</b>	<b>P34GY</b>	<b>P34BK</b>
36"H Post	2 lbs	<b>P36C</b>	-	-	-	-
39"H Post	2 lbs	<b>P39C</b>	-	-	-	<b>P39BK</b>
42"H Post	2 lbs	-	<b>P42S</b>	-	-	-
54"H Post	3 lbs	<b>P54C</b>	<b>P54S</b>	<b>P54P</b>	<b>P54GY</b>	<b>P54BK</b>
63"H Post	4 lbs	<b>P63C*</b>	<b>P63S</b>	<b>P63P*</b>	<b>P63GY*</b>	<b>P63BK*</b>
74"H Post	4 lbs	<b>P74C*</b>	<b>P74S</b>	<b>P74P*</b>	<b>P74GY*</b>	<b>P74BK*</b>
86"H Post	5 lbs	<b>P86C*</b>	<b>P86S</b>	<b>P86P*</b>	<b>P86GY*</b>	<b>P86BK*</b>
96"H Post	6 lbs	<b>P96C</b>	<b>P96S</b>	<b>P96P</b>	<b>P96GY</b>	<b>P96BK</b>

\***PRE-INSERTED LEVELERS** For easy installation, 63", 74" and 86" posts are available with pre-inserted leveler and bolt by adding an **X** to the Model No. P74CX

## EASY IDENTIFICATION OF AISLES/ROWS CONTENTS

### Post Label Holders

New post label holders come in two sizes and allow for easy identification of aisles/rows as well as of wire cart contents. Attach to standard 1" diameter posts. Each package includes 12 clear holders and corresponding printer friendly sheet labels.

MODEL NO.	DIMENSIONS W" x L"	PKG QTY	SHIP WGT
<b>PLH1X6C</b>	1" x 6"	12 pcs	1 lb
<b>PLH2X4C</b>	2" x 4"	12 pcs	1 lb



## ASSEMBLING WIRE SHELVING UNITS IS AS EASY AS 1 - 2 - 3...

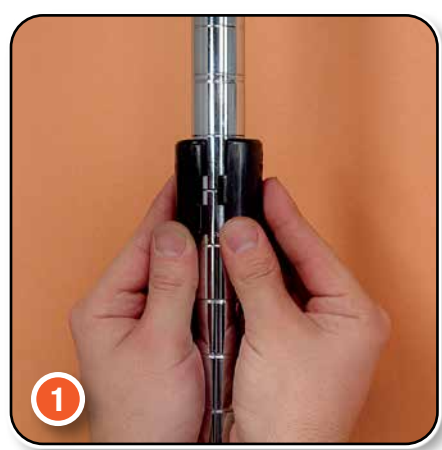

1 Snap plastic sleeve around post.

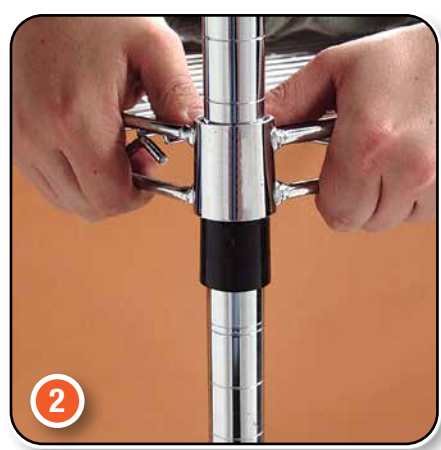

2 Slide shelf over sleeve for secure locking.

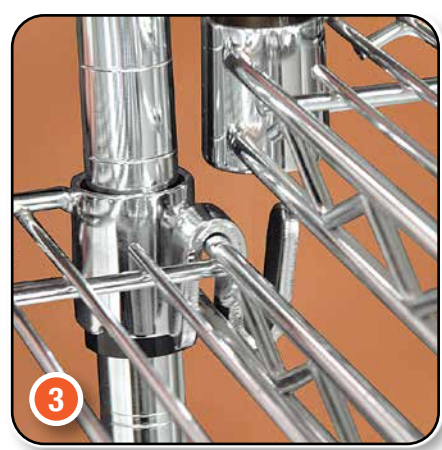

3 Two "S-Hooks" are used to connect add-on wire shelf to starter units.

**W-PC**  
**Replacement Post Cap**  
Additional pieces available  
(Sold as 4-pack)

**W-PC-STUD**  
Threaded **Stud Connector** can be utilized to connect two posts enabling any post height to be achieved. Must be used with **WR-WMB** to secure to wall  
See **pg. 166**

**LASER PRINTED NUMBERS**  
For quick shelf positioning

**W-PLI**  
**Post Insert**  
Additional pieces available  
(Sold as 4-pack)

**W-PLB / W-PLBS**  
**Post Leveler** adjusts up or down allowing height flexibility. Additional pieces available  
(Sold as 4-pack)



**Starter Kits**



Heavy-duty shelving units allow up to 800 lb. shelf capacity. Starter kits come complete with 4 posts and 4 or 5 shelves. Additional shelves may be purchased separately. See chart on **pg. 104**. Mobilize starter kit shelving unit using optional mobile kit, **WR-00H**, see **pg. 167**. **Finishes:** Chrome, Stainless Steel, Proform Green, Gray and Black Epoxy



**MOBILIZE YOUR WIRE SHELVING**

**DB - Donut Bumper**  
Non-marking donut bumper used to protect walls and help cushion impact.

**WR-00H (Mobile Kit)\***  
Set of four swivel thermoplastic resin 5" x 1-1/4" casters, two with brakes. Can be used with all units shown. Up to 1,200 lb. load capacity. \*Mobile kits recommended only for shelves 18" and deeper.

**Up to 600-800 lb.**  
**LOAD CAPACITY PER SHELF**

**TO CHOOSE FINISH ADD FINISH SUFFIX TO MODEL NO.**

Ex: **Chrome** WR54-1236C  
**Stainless** WR54-1236S  
**Proform Green** WR54-1236P  
**Gray** WR54-1236GY  
**Black** WR54-1236BK

Ex: **Chrome** WR54-1236C-5  
**Stainless** WR54-1236S-5  
**Proform Green** WR54-1236P-5  
**Gray** WR54-1236GY-5  
**Black** WR54-1236BK-5

**Chrome**  
**Stainless**  
**Proform Green**  
**GY Gray**  
**BK Black**



**4 SHELF STARTER KIT**  
Stainless Steel Finish

SHELF W" x L"	54"H - WIRE SHELVING 4 SHELVES				54"H - WIRE SHELVING 5 SHELVES				AVAILABLE FINISHES					
	STARTER KIT	ADD-ON KIT	STARTER KIT	ADD-ON KIT	STARTER KIT	ADD-ON KIT	STARTER KIT	ADD-ON KIT						
MODEL NO.	SHIP WGT	MODEL NO.	SHIP WGT	MODEL NO.	SHIP WGT	MODEL NO.	SHIP WGT	MODEL NO.	SHIP WGT	C	S	P	GY	BK
12" x 36"	WR54-1236	40 lbs	AD54-1236	36 lbs	WR54-1236-5	47 lbs	AD54-1236-5	45 lbs	WR54-1236-5	Y	Y	Y	Y	Y
12" x 42"	WR54-1242	44 lbs	AD54-1242	40 lbs	WR54-1242-5	52 lbs	AD54-1242-5	50 lbs	WR54-1242-5	Y	N	Y	Y	Y
12" x 48"	WR54-1248	48 lbs	AD54-1248	44 lbs	WR54-1248-5	57 lbs	AD54-1248-5	55 lbs	WR54-1248-5	Y	Y	Y	Y	Y
12" x 60"	WR54-1260	56 lbs	AD54-1260	52 lbs	WR54-1260-5	70 lbs	AD54-1260-5	68 lbs	WR54-1260-5	Y	Y	Y	Y	Y
12" x 72"	WR54-1272	64 lbs	AD54-1272	60 lbs	WR54-1272-5	81 lbs	AD54-1272-5	79 lbs	WR54-1272-5	Y	Y	Y	Y	Y
14" x 24"	WR54-1424	36 lbs	AD54-1424	32 lbs	WR54-1424-5	42 lbs	AD54-1424-5	40 lbs	WR54-1424-5	Y	N	Y	Y	Y
14" x 30"	WR54-1430	40 lbs	AD54-1430	36 lbs	WR54-1430-5	47 lbs	AD54-1430-5	45 lbs	WR54-1430-5	Y	Y	Y	Y	Y
14" x 36"	WR54-1436	44 lbs	AD54-1436	40 lbs	WR54-1436-5	52 lbs	AD54-1436-5	50 lbs	WR54-1436-5	Y	Y	Y	Y	Y
14" x 42"	WR54-1442	52 lbs	AD54-1442	48 lbs	WR54-1442-5	62 lbs	AD54-1442-5	60 lbs	WR54-1442-5	Y	Y	Y	Y	Y
14" x 48"	WR54-1448	56 lbs	AD54-1448	52 lbs	WR54-1448-5	67 lbs	AD54-1448-5	65 lbs	WR54-1448-5	Y	Y	Y	Y	Y
14" x 54"	WR54-1454	60 lbs	AD54-1454	56 lbs	WR54-1454-5	72 lbs	AD54-1454-5	70 lbs	WR54-1454-5	Y	Y	Y	Y	Y
14" x 60"	WR54-1460	68 lbs	AD54-1460	64 lbs	WR54-1460-5	82 lbs	AD54-1460-5	80 lbs	WR54-1460-5	Y	Y	Y	Y	Y
14" x 72"	WR54-1472	80 lbs	AD54-1472	76 lbs	WR54-1472-5	97 lbs	AD54-1472-5	95 lbs	WR54-1472-5	Y	Y	Y	Y	Y
18" x 24"	WR54-1824	40 lbs	AD54-1824	36 lbs	WR54-1824-5	47 lbs	AD54-1824-5	45 lbs	WR54-1824-5	Y	Y	Y	Y	Y
18" x 30"	WR54-1830	44 lbs	AD54-1830	40 lbs	WR54-1830-5	52 lbs	AD54-1830-5	50 lbs	WR54-1830-5	Y	Y	Y	Y	Y
18" x 36"	WR54-1836	52 lbs	AD54-1836	48 lbs	WR54-1836-5	62 lbs	AD54-1836-5	60 lbs	WR54-1836-5	Y	Y	Y	Y	Y
18" x 42"	WR54-1842	56 lbs	AD54-1842	52 lbs	WR54-1842-5	67 lbs	AD54-1842-5	65 lbs	WR54-1842-5	Y	Y	Y	Y	Y
18" x 48"	WR54-1848	60 lbs	AD54-1848	56 lbs	WR54-1848-5	74 lbs	AD54-1848-5	72 lbs	WR54-1848-5	Y	Y	Y	Y	Y
18" x 54"	WR54-1854	72 lbs	AD54-1854	68 lbs	WR54-1854-5	87 lbs	AD54-1854-5	81 lbs	WR54-1854-5	Y	Y	Y	Y	Y
18" x 60"	WR54-1860	80 lbs	AD54-1860	76 lbs	WR54-1860-5	97 lbs	AD54-1860-5	95 lbs	WR54-1860-5	Y	Y	Y	Y	Y
18" x 72"	WR54-1872	92 lbs	AD54-1872	88 lbs	WR54-1872-5	112 lbs	AD54-1872-5	58 lbs	WR54-1872-5	Y	Y	Y	Y	Y
21" x 24"	WR54-2124	44 lbs	AD54-2124	40 lbs	WR54-2124-5	52 lbs	AD54-2124-5	50 lbs	WR54-2124-5	Y	Y	Y	Y	Y
21" x 30"	WR54-2130	48 lbs	AD54-2130	44 lbs	WR54-2130-5	57 lbs	AD54-2130-5	59 lbs	WR54-2130-5	Y	Y	Y	Y	Y
21" x 36"	WR54-2136	56 lbs	AD54-2136	52 lbs	WR54-2136-5	67 lbs	AD54-2136-5	65 lbs	WR54-2136-5	Y	Y	Y	Y	Y
21" x 42"	WR54-2142	60 lbs	AD54-2142	56 lbs	WR54-2142-5	72 lbs	AD54-2142-5	70 lbs	WR54-2142-5	Y	Y	Y	Y	Y
21" x 48"	WR54-2148	68 lbs	AD54-2148	64 lbs	WR54-2148-5	82 lbs	AD54-2148-5	84 lbs	WR54-2148-5	Y	Y	Y	Y	Y
21" x 54"	WR54-2154	76 lbs	AD54-2154	72 lbs	WR54-2154-5	92 lbs	AD54-2154-5	94 lbs	WR54-2154-5	Y	Y	Y	Y	Y
21" x 60"	WR54-2160	84 lbs	AD54-2160	80 lbs	WR54-2160-5	102 lbs	AD54-2160-5	108 lbs	WR54-2160-5	Y	Y	Y	Y	Y
21" x 72"	WR54-2172	108 lbs	AD54-2172	104 lbs	WR54-2172-5	132 lbs	AD54-2172-5	130 lbs	WR54-2172-5	Y	Y	Y	Y	Y
24" x 24"	WR54-2424	48 lbs	AD54-2424	44 lbs	WR54-2424-5	57 lbs	AD54-2424-5	55 lbs	WR54-2424-5	Y	Y	Y	Y	Y
24" x 30"	WR54-2430	56 lbs	AD54-2430	52 lbs	WR54-2430-5	67 lbs	AD54-2430-5	65 lbs	WR54-2430-5	Y	Y	Y	Y	Y
24" x 36"	WR54-2436	64 lbs	AD54-2436	60 lbs	WR54-2436-5	77 lbs	AD54-2436-5	75 lbs	WR54-2436-5	Y	Y	Y	Y	Y
24" x 42"	WR54-2442	72 lbs	AD54-2442	68 lbs	WR54-2442-5	87 lbs	AD54-2442-5	85 lbs	WR54-2442-5	Y	Y	Y	Y	Y
24" x 48"	WR54-2448	76 lbs	AD54-2448	72 lbs	WR54-2448-5	92 lbs	AD54-2448-5	90 lbs	WR54-2448-5	Y	Y	Y	Y	Y
24" x 54"	WR54-2454	84 lbs	AD54-2454	80 lbs	WR54-2454-5	102 lbs	AD54-2454-5	100 lbs	WR54-2454-5	Y	Y	Y	Y	Y
24" x 60"	WR54-2460	96 lbs	AD54-2460	92 lbs	WR54-2460-5	117 lbs	AD54-2460-5	115 lbs	WR54-2460-5	Y	Y	Y	Y	Y
24" x 72"	WR54-2472	116 lbs	AD54-2472	112 lbs	WR54-2472-5	142 lbs	AD54-2472-5	142 lbs	WR54-2472-5	Y	Y	Y	Y	Y
30" x 36"	WR54-3036	72 lbs	AD54-3036	68 lbs	WR54-3036-5	87 lbs	AD54-3036-5	85 lbs	WR54-3036-5	Y	Y	Y	Y	Y
30" x 42"	WR54-3042	84 lbs	AD54-3042	80 lbs	WR54-3042-5	102 lbs	AD54-3042-5	100 lbs	WR54-3042-5	Y	Y	Y	Y	Y
30" x 48"	WR54-3048	96 lbs	AD54-3048	92 lbs	WR54-3048-5	117 lbs	AD54-3048-5	115 lbs	WR54-3048-5	Y	Y	Y	Y	Y
30" x 60"	WR54-3060	120 lbs	AD54-3060	116 lbs	WR54-3060-5	147 lbs	AD54-3060-5	145 lbs	WR54-3060-5	Y	Y	Y	Y	Y
30" x 72"	WR54-3072	136 lbs	AD54-3072	132 lbs	WR54-3072-5	167 lbs	AD54-3072-5	165 lbs	WR54-3072-5	Y	Y	Y	Y	Y
36" x 36"	WR54-3636	84 lbs	AD54-3636	80 lbs	WR54-3636-5	102 lbs	AD54-3636-5	100 lbs	WR54-3636-5	Y	Y	Y	Y	Y
36" x 48"	WR54-3648	104 lbs	AD54-3648	100 lbs	WR54-3648-5	127 lbs	AD54-3648-5	125 lbs	WR54-3648-5	Y	Y	Y	Y	Y
36" x 60"	WR54-3660	128 lbs	AD54-3660	124 lbs	WR54-3660-5	157 lbs	AD54-3660-5	155 lbs	WR54-3660-5	Y	Y	Y	Y	Y
36" x 72"	WR54-3672	136 lbs	AD54-3672	132 lbs	WR54-3672-5	171 lbs	AD54-3672-5	169 lbs	WR54-3672-5	Y	Y	Y	Y	Y

Shelving units include 4 posts and 4 or 5 shelves. Add-On units include 2 posts, 4 or 5 shelves and 8 or 10 S-Hooks.

Y (Yes) N (No)



**Add-On Kits**



Additional Add-On kits allow you to expand your Starter kit by sharing a middle set of posts. Configuration options include side to side, back to back and right angles (*L-Shape*). Add-On kits come complete with 2 posts, 4 or 5 shelves and 8 or 10 S-Hooks. Additional shelves and posts may be purchased separately. See chart on **pg. 104**. Units with Add-On kits cannot be made mobile. **Finishes:** Chrome, Stainless Steel, Proform Green, Gray and Black Epoxy

**Up to 600-800 lb.**  
**LOAD CAPACITY PER SHELF**

**TO CHOOSE FINISH ADD FINISH SUFFIX TO MODEL NO.**

Ex: **Chrome** WR63-1236C  
**Stainless** WR63-1236S  
**Proform Green** WR63-1236P  
**Gray** WR63-1236GY  
**Black** WR63-1236BK

Ex: **Chrome** WR63-1236C-5  
**Stainless** WR63-1236S-5  
**Proform Green** WR63-1236P-5  
**Gray** WR63-1236GY-5  
**Black** WR63-1236BK-5

**Chrome**  
**Stainless**  
**Proform Green**  
**GY** Gray  
**BK** Black

SHELF W" x L"	63"H - WIRE SHELVING 4 SHELVES				63"H - WIRE SHELVING 5 SHELVES				AVAILABLE FINISHES				
	MODEL NO.	SHIP WGT	MODEL NO.	SHIP WGT	MODEL NO.	SHIP WGT	MODEL NO.	SHIP WGT	C	S	P	GY	BK
12" x 36"	WR63-1236	42 lbs	AD63-1236	37 lbs	WR63-1236-5	49 lbs	AD63-1236-5	46 lbs	Y	Y	Y	Y	Y
12" x 42"	WR63-1242	46 lbs	AD63-1242	41 lbs	WR63-1242-5	54 lbs	AD63-1242-5	51 lbs	Y	N	Y	Y	Y
12" x 48"	WR63-1248	52 lbs	AD63-1248	43 lbs	WR63-1248-5	74 lbs	AD63-1248-5	56 lbs	Y	N	Y	Y	Y
12" x 60"	WR63-1260	60 lbs	AD63-1260	51 lbs	WR63-1260-5	61 lbs	AD63-1260-5	69 lbs	Y	Y	Y	Y	Y
12" x 72"	WR63-1272	68 lbs	AD63-1272	59 lbs	WR63-1272-5	85 lbs	AD63-1272-5	80 lbs	Y	Y	Y	Y	Y
14" x 24"	WR63-1424	40 lbs	AD63-1424	31 lbs	WR63-1424-5	46 lbs	AD63-1424-5	41 lbs	Y	N	Y	Y	Y
14" x 30"	WR63-1430	44 lbs	AD63-1430	35 lbs	WR63-1430-5	51 lbs	AD63-1430-5	46 lbs	Y	Y	Y	Y	Y
14" x 36"	WR63-1436	48 lbs	AD63-1436	39 lbs	WR63-1436-5	56 lbs	AD63-1436-5	51 lbs	Y	Y	Y	Y	Y
14" x 42"	WR63-1442	56 lbs	AD63-1442	47 lbs	WR63-1442-5	66 lbs	AD63-1442-5	61 lbs	Y	Y	Y	Y	Y
14" x 48"	WR63-1448	60 lbs	AD63-1448	51 lbs	WR63-1448-5	71 lbs	AD63-1448-5	66 lbs	Y	Y	Y	Y	Y
14" x 54"	WR63-1454	64 lbs	AD63-1454	55 lbs	WR63-1454-5	76 lbs	AD63-1454-5	71 lbs	Y	Y	Y	Y	Y
14" x 60"	WR63-1460	72 lbs	AD63-1460	63 lbs	WR63-1460-5	86 lbs	AD63-1460-5	81 lbs	Y	Y	Y	Y	Y
14" x 72"	WR63-1472	84 lbs	AD63-1472	75 lbs	WR63-1472-5	101 lbs	AD63-1472-5	96 lbs	Y	Y	Y	Y	Y
18" x 24"	WR63-1824	44 lbs	AD63-1824	35 lbs	WR63-1824-5	51 lbs	AD63-1824-5	46 lbs	Y	Y	Y	Y	Y
18" x 30"	WR63-1830	48 lbs	AD63-1830	39 lbs	WR63-1830-5	56 lbs	AD63-1830-5	51 lbs	Y	Y	Y	Y	Y
18" x 36"	WR63-1836	54 lbs	AD63-1836	49 lbs	WR63-1836-5	64 lbs	AD63-1836-5	61 lbs	Y	Y	Y	Y	Y
18" x 42"	WR63-1842	58 lbs	AD63-1842	53 lbs	WR63-1842-5	69 lbs	AD63-1842-5	66 lbs	Y	Y	Y	Y	Y
18" x 48"	WR63-1848	62 lbs	AD63-1848	57 lbs	WR63-1848-5	76 lbs	AD63-1848-5	73 lbs	Y	Y	Y	Y	Y
18" x 54"	WR63-1854	74 lbs	AD63-1854	69 lbs	WR63-1854-5	89 lbs	AD63-1854-5	86 lbs	Y	Y	Y	Y	Y
18" x 60"	WR63-1860	82 lbs	AD63-1860	77 lbs	WR63-1860-5	99 lbs	AD63-1860-5	96 lbs	Y	Y	Y	Y	Y
18" x 72"	WR63-1872	94 lbs	AD63-1872	89 lbs	WR63-1872-5	114 lbs	AD63-1872-5	111 lbs	Y	Y	Y	Y	Y
21" x 24"	WR63-2124	46 lbs	AD63-2124	41 lbs	WR63-2124-5	54 lbs	AD63-2124-5	51 lbs	Y	Y	Y	Y	Y
21" x 30"	WR63-2130	50 lbs	AD63-2130	45 lbs	WR63-2130-5	59 lbs	AD63-2130-5	56 lbs	Y	Y	Y	Y	Y
21" x 36"	WR63-2136	58 lbs	AD63-2136	53 lbs	WR63-2136-5	69 lbs	AD63-2136-5	66 lbs	Y	Y	Y	Y	Y
21" x 42"	WR63-2142	62 lbs	AD63-2142	57 lbs	WR63-2142-5	74 lbs	AD63-2142-5	71 lbs	Y	Y	Y	Y	Y
21" x 48"	WR63-2148	70 lbs	AD63-2148	65 lbs	WR63-2148-5	84 lbs	AD63-2148-5	81 lbs	Y	Y	Y	Y	Y
21" x 54"	WR63-2154	78 lbs	AD63-2154	73 lbs	WR63-2154-5	94 lbs	AD63-2154-5	91 lbs	Y	Y	Y	Y	Y
21" x 60"	WR63-2160	86 lbs	AD63-2160	81 lbs	WR63-2160-5	104 lbs	AD63-2160-5	101 lbs	Y	Y	Y	Y	Y
21" x 72"	WR63-2172	110 lbs	AD63-2172	105 lbs	WR63-2172-5	134 lbs	AD63-2172-5	131 lbs	Y	Y	Y	Y	Y
24" x 24"	WR63-2424	50 lbs	AD63-2424	45 lbs	WR63-2424-5	59 lbs	AD63-2424-5	56 lbs	Y	Y	Y	Y	Y
24" x 30"	WR63-2430	58 lbs	AD63-2430	53 lbs	WR63-2430-5	69 lbs	AD63-2430-5	66 lbs	Y	Y	Y	Y	Y
24" x 36"	WR63-2436	66 lbs	AD63-2436	61 lbs	WR63-2436-5	79 lbs	AD63-2436-5	76 lbs	Y	Y	Y	Y	Y
24" x 42"	WR63-2442	74 lbs	AD63-2442	69 lbs	WR63-2442-5	89 lbs	AD63-2442-5	86 lbs	Y	Y	Y	Y	Y
24" x 48"	WR63-2448	78 lbs	AD63-2448	73 lbs	WR63-2448-5	94 lbs	AD63-2448-5	91 lbs	Y	Y	Y	Y	Y
24" x 54"	WR63-2454	86 lbs	AD63-2454	81 lbs	WR63-2454-5	104 lbs	AD63-2454-5	101 lbs	Y	Y	Y	Y	Y
24" x 60"	WR63-2460	98 lbs	AD63-2460	93 lbs	WR63-2460-5	119 lbs	AD63-2460-5	116 lbs	Y	Y	Y	Y	Y
24" x 72"	WR63-2472	118 lbs	AD63-2472	113 lbs	WR63-2472-5	144 lbs	AD63-2472-5	141 lbs	Y	Y	Y	Y	Y
30" x 36"	WR63-3036	74 lbs	AD63-3036	69 lbs	WR63-3036-5	89 lbs	AD63-3036-5	86 lbs	Y	Y	Y	Y	Y
30" x 42"	WR63-3042	86 lbs	AD63-3042	81 lbs	WR63-3042-5	104 lbs	AD63-3042-5	101 lbs	Y	Y	Y	Y	Y
30" x 48"	WR63-3048	98 lbs	AD63-3048	93 lbs	WR63-3048-5	119 lbs	AD63-3048-5	116 lbs	Y	Y	Y	Y	Y
30" x 60"	WR63-3060	122 lbs	AD63-3060	117 lbs	WR63-3060-5	149 lbs	AD63-3060-5	146 lbs	Y	Y	Y	Y	Y
30" x 72"	WR63-3072	138 lbs	AD63-3072	133 lbs	WR63-3072-5	169 lbs	AD63-3072-5	166 lbs	Y	Y	Y	Y	Y
36" x 36"	WR63-3636	86 lbs	AD63-3636	81 lbs	WR63-3636-5	104 lbs	AD63-3636-5	101 lbs	Y	Y	Y	Y	Y
36" x 48"	WR63-3648	106 lbs	AD63-3648	101 lbs	WR63-3648-5	129 lbs	AD63-3648-5	126 lbs	Y	Y	Y	Y	Y
36" x 60"	WR63-3660	130 lbs	AD63-3660	125 lbs	WR63-3660-5	159 lbs	AD63-3660-5	156 lbs	Y	Y	Y	Y	Y
36" x 72"	WR63-3672	138 lbs	AD63-3672	133 lbs	WR63-3672-5	173 lbs	AD63-3672-5	170 lbs	Y	Y	Y	Y	Y

Shelving units include 4 posts and 4 or 5 shelves. Add-On units include 2 posts, 4 or 5 shelves and 8 or 10 S-Hooks.

Y (Yes) N (No)

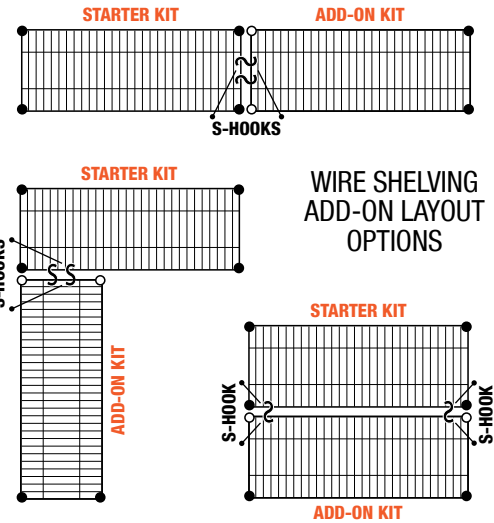

**S-HOOK**  
For continuous runs of shelving. Two hooks should be placed per shelf where two posts are not utilized. For available finishes, see **pg. 166**



**4 SHELF ADD-ON KIT**  
Chrome Finish

Starter Kits



Heavy-duty shelving units allow up to 800 lb. shelf capacity. Starter kits come complete with 4 posts and 4 or 5 shelves. Additional shelves may be purchased separately. See chart on pg. 104. Mobilize starter kit shelving unit using optional mobile kit, WR-00H, see pg. 167. **Finishes:** Chrome, Stainless Steel, Proform Green, Gray and Black Epoxy

**Up to 600-800 lb.**  
LOAD CAPACITY PER SHELF

TO CHOOSE FINISH ADD FINISH SUFFIX TO MODEL NO.

Ex: **Chrome** WR74-1236C  
**Stainless** WR74-1236S  
**Proform Green** WR74-1236P  
**Gray** WR74-1236GY  
**Black** WR74-1236BK

Ex: **Chrome** WR74-1236C-5  
**Stainless** WR74-1236S-5  
**Proform Green** WR74-1236P-5  
**Gray** WR74-1236GY-5  
**Black** WR74-1236BK-5

**Chrome**  
**Stainless**  
**Proform Green**  
**GY** Gray  
**BK** Black



MOBILIZE YOUR WIRE SHELVING

**DB - Donut Bumper**  
Non-marking donut bumper used to protect walls and help cushion impact.

**WR-00H (Mobile Kit)\***  
Set of four swivel thermoplastic resin 5" x 1-1/4" casters, two with brakes. Can be used with all units shown. Up to 1,200 lb. load capacity. \*Mobile kits recommended only for shelves 18" and deeper.



4 SHELF STARTER KIT  
Proform Green Epoxy Finish



5 SHELF STARTER KIT  
Black Epoxy Finish

SHELF W" x L"	74"H - WIRE SHELVING 4 SHELVES				74"H - WIRE SHELVING 5 SHELVES				AVAILABLE FINISHES				
	MODEL NO.	SHIP WGT	MODEL NO.	SHIP WGT	MODEL NO.	SHIP WGT	MODEL NO.	SHIP WGT	C	S	P	GY	BK
12" x 36"	WR74-1236	44 lbs	AD74-1236	38 lbs	WR74-1236-5	51 lbs	AD74-1236-5	47 lbs	Y	Y	Y	Y	Y
12" x 42"	WR74-1242	48 lbs	AD74-1242	42 lbs	WR74-1242-5	56 lbs	AD74-1242-5	52 lbs	Y	N	Y	Y	Y
12" x 48"	WR74-1248	52 lbs	AD74-1248	46 lbs	WR74-1248-5	61 lbs	AD74-1248-5	57 lbs	Y	Y	Y	Y	Y
12" x 60"	WR74-1260	60 lbs	AD74-1260	54 lbs	WR74-1260-5	74 lbs	AD74-1260-5	70 lbs	Y	Y	Y	Y	Y
12" x 72"	WR74-1272	68 lbs	AD74-1272	62 lbs	WR74-1272-5	85 lbs	AD74-1272-5	81 lbs	Y	Y	Y	Y	Y
14" x 24"	WR74-1424	40 lbs	AD74-1424	34 lbs	WR74-1424-5	46 lbs	AD74-1424-5	42 lbs	Y	N	Y	Y	Y
14" x 30"	WR74-1430	44 lbs	AD74-1430	38 lbs	WR74-1430-5	51 lbs	AD74-1430-5	47 lbs	Y	Y	Y	Y	Y
14" x 36"	WR74-1436	48 lbs	AD74-1436	42 lbs	WR74-1436-5	56 lbs	AD74-1436-5	52 lbs	Y	Y	Y	Y	Y
14" x 42"	WR74-1442	56 lbs	AD74-1442	50 lbs	WR74-1442-5	66 lbs	AD74-1442-5	62 lbs	Y	Y	Y	Y	Y
14" x 48"	WR74-1448	60 lbs	AD74-1448	54 lbs	WR74-1448-5	71 lbs	AD74-1448-5	67 lbs	Y	Y	Y	Y	Y
14" x 54"	WR74-1454	64 lbs	AD74-1454	58 lbs	WR74-1454-5	76 lbs	AD74-1454-5	72 lbs	Y	Y	Y	Y	Y
14" x 60"	WR74-1460	72 lbs	AD74-1460	66 lbs	WR74-1460-5	86 lbs	AD74-1460-5	82 lbs	Y	Y	Y	Y	Y
14" x 72"	WR74-1472	84 lbs	AD74-1472	78 lbs	WR74-1472-5	101 lbs	AD74-1472-5	97 lbs	Y	Y	Y	Y	Y
18" x 24"	WR74-1824	44 lbs	AD74-1824	38 lbs	WR74-1824-5	51 lbs	AD74-1824-5	47 lbs	Y	Y	Y	Y	Y
18" x 30"	WR74-1830	48 lbs	AD74-1830	42 lbs	WR74-1830-5	56 lbs	AD74-1830-5	52 lbs	Y	Y	Y	Y	Y
18" x 36"	WR74-1836	56 lbs	AD74-1836	50 lbs	WR74-1836-5	66 lbs	AD74-1836-5	62 lbs	Y	Y	Y	Y	Y
18" x 42"	WR74-1842	60 lbs	AD74-1842	54 lbs	WR74-1842-5	71 lbs	AD74-1842-5	67 lbs	Y	Y	Y	Y	Y
18" x 48"	WR74-1848	64 lbs	AD74-1848	58 lbs	WR74-1848-5	78 lbs	AD74-1848-5	74 lbs	Y	Y	Y	Y	Y
18" x 54"	WR74-1854	76 lbs	AD74-1854	70 lbs	WR74-1854-5	91 lbs	AD74-1854-5	87 lbs	Y	Y	Y	Y	Y
18" x 60"	WR74-1860	84 lbs	AD74-1860	78 lbs	WR74-1860-5	101 lbs	AD74-1860-5	97 lbs	Y	Y	Y	Y	Y
18" x 72"	WR74-1872	96 lbs	AD74-1872	90 lbs	WR74-1872-5	116 lbs	AD74-1872-5	112 lbs	Y	Y	Y	Y	Y
21" x 24"	WR74-2124	48 lbs	AD74-2124	42 lbs	WR74-2124-5	56 lbs	AD74-2124-5	52 lbs	Y	Y	Y	Y	Y
21" x 30"	WR74-2130	52 lbs	AD74-2130	46 lbs	WR74-2130-5	61 lbs	AD74-2130-5	57 lbs	Y	Y	Y	Y	Y
21" x 36"	WR74-2136	60 lbs	AD74-2136	54 lbs	WR74-2136-5	71 lbs	AD74-2136-5	67 lbs	Y	Y	Y	Y	Y
21" x 42"	WR74-2142	64 lbs	AD74-2142	58 lbs	WR74-2142-5	76 lbs	AD74-2142-5	72 lbs	Y	Y	Y	Y	Y
21" x 48"	WR74-2148	72 lbs	AD74-2148	66 lbs	WR74-2148-5	86 lbs	AD74-2148-5	82 lbs	Y	Y	Y	Y	Y
21" x 54"	WR74-2154	80 lbs	AD74-2154	74 lbs	WR74-2154-5	96 lbs	AD74-2154-5	92 lbs	Y	Y	Y	Y	Y
21" x 60"	WR74-2160	88 lbs	AD74-2160	82 lbs	WR74-2160-5	106 lbs	AD74-2160-5	102 lbs	Y	Y	Y	Y	Y
21" x 72"	WR74-2172	112 lbs	AD74-2172	106 lbs	WR74-2172-5	136 lbs	AD74-2172-5	132 lbs	Y	Y	Y	Y	Y
24" x 24"	WR74-2424	52 lbs	AD74-2424	46 lbs	WR74-2424-5	61 lbs	AD74-2424-5	57 lbs	Y	Y	Y	Y	Y
24" x 30"	WR74-2430	60 lbs	AD74-2430	54 lbs	WR74-2430-5	71 lbs	AD74-2430-5	67 lbs	Y	Y	Y	Y	Y
24" x 36"	WR74-2436	68 lbs	AD74-2436	62 lbs	WR74-2436-5	81 lbs	AD74-2436-5	77 lbs	Y	Y	Y	Y	Y
24" x 42"	WR74-2442	76 lbs	AD74-2442	70 lbs	WR74-2442-5	91 lbs	AD74-2442-5	87 lbs	Y	Y	Y	Y	Y
24" x 48"	WR74-2448	80 lbs	AD74-2448	74 lbs	WR74-2448-5	96 lbs	AD74-2448-5	92 lbs	Y	Y	Y	Y	Y
24" x 54"	WR74-2454	88 lbs	AD74-2454	82 lbs	WR74-2454-5	106 lbs	AD74-2454-5	102 lbs	Y	Y	Y	Y	Y
24" x 60"	WR74-2460	100 lbs	AD74-2460	94 lbs	WR74-2460-5	121 lbs	AD74-2460-5	117 lbs	Y	Y	Y	Y	Y
24" x 72"	WR74-2472	120 lbs	AD74-2472	114 lbs	WR74-2472-5	146 lbs	AD74-2472-5	142 lbs	Y	Y	Y	Y	Y
30" x 36"	WR74-3036	76 lbs	AD74-3036	70 lbs	WR74-3036-5	91 lbs	AD74-3036-5	87 lbs	Y	Y	Y	Y	Y
30" x 42"	WR74-3042	88 lbs	AD74-3042	82 lbs	WR74-3042-5	106 lbs	AD74-3042-5	102 lbs	Y	Y	Y	Y	Y
30" x 48"	WR74-3048	100 lbs	AD74-3048	94 lbs	WR74-3048-5	121 lbs	AD74-3048-5	117 lbs	Y	Y	Y	Y	Y
30" x 60"	WR74-3060	124 lbs	AD74-3060	118 lbs	WR74-3060-5	151 lbs	AD74-3060-5	147 lbs	Y	Y	Y	Y	Y
30" x 72"	WR74-3072	140 lbs	AD74-3072	134 lbs	WR74-3072-5	171 lbs	AD74-3072-5	167 lbs	Y	Y	Y	Y	Y
36" x 36"	WR74-3636	88 lbs	AD74-3636	82 lbs	WR74-3636-5	106 lbs	AD74-3636-5	102 lbs	Y	Y	Y	Y	Y
36" x 48"	WR74-3648	108 lbs	AD74-3648	102 lbs	WR74-3648-5	131 lbs	AD74-3648-5	127 lbs	Y	Y	Y	Y	Y
36" x 60"	WR74-3660	132 lbs	AD74-3660	126 lbs	WR74-3660-5	161 lbs	AD74-3660-5	157 lbs	Y	Y	Y	Y	Y
36" x 72"	WR74-3672	140 lbs	AD74-3672	134 lbs	WR74-3672-5	175 lbs	AD74-3672-5	171 lbs	Y	Y	Y	Y	Y

Shelving units include 4 posts and 4 or 5 shelves. Add-On units include 2 posts, 4 or 5 shelves and 8 or 10 S-Hooks. Y (Yes) N (No)

**Add-On Kits**



Additional Add-On kits allow you to expand your Starter kit by sharing a set of posts. Configuration options include side to side, back to back and right angles (L-Shape). Add-On kits come complete with 2 posts, 4 or 5 shelves and 8 or 10 S-Hooks. Additional shelves and posts may be purchased separately. See chart on **pg. 104**. Units with Add-On kit cannot be made mobile. **Finishes:** Chrome, Stainless Steel, Proform Green, Gray and Black Epoxy

**Up to 600-800 lb.**  
**LOAD CAPACITY PER SHELF**

**TO CHOOSE FINISH ADD FINISH SUFFIX TO MODEL NO.**

Ex: **Chrome** WR86-1236C  
**Stainless** WR86-1236S  
**Proform Green** WR86-1236P  
**Gray** WR86-1236GY  
**Black** WR86-1236BK

Ex: **Chrome** WR86-1236C-5  
**Stainless** WR86-1236S-5  
**Proform Green** WR86-1236P-5  
**Gray** WR86-1236GY-5  
**Black** WR86-1236BK-5

**Chrome**  
**Stainless**  
**Proform Green**  
**GY** Gray  
**BK** Black

SHELF W" x L"	86"H - WIRE SHELVING 4 SHELVES		86"H - WIRE SHELVING 5 SHELVES		86"H - WIRE SHELVING 5 SHELVES		AVAILABLE		
	STARTER KIT	ADD-ON KIT	STARTER KIT	ADD-ON KIT	STARTER KIT	ADD-ON KIT	C	S P GY BK	
12" x 36"	WR86-1236	48 lbs	AD86-1236	40 lbs	WR86-1236-5	55 lbs	AD86-1236-5	49 lbs	Y Y Y Y Y
12" x 42"	WR86-1242	52 lbs	AD86-1242	44 lbs	WR86-1242-5	60 lbs	AD86-1242-5	54 lbs	Y N Y Y Y
12" x 48"	WR86-1248	56 lbs	AD86-1248	48 lbs	WR86-1248-5	65 lbs	AD86-1248-5	59 lbs	Y Y Y Y Y
12" x 60"	WR86-1260	64 lbs	AD86-1260	56 lbs	WR86-1260-5	78 lbs	AD86-1260-5	72 lbs	Y Y Y Y Y
12" x 72"	WR86-1272	72 lbs	AD86-1272	64 lbs	WR86-1272-5	89 lbs	AD86-1272-5	83 lbs	Y Y Y Y Y
14" x 24"	WR86-1424	44 lbs	AD86-1424	36 lbs	WR86-1424-5	50 lbs	AD86-1424-5	44 lbs	Y N Y Y Y
14" x 30"	WR86-1430	48 lbs	AD86-1430	40 lbs	WR86-1430-5	55 lbs	AD86-1430-5	49 lbs	Y Y Y Y Y
14" x 36"	WR86-1436	52 lbs	AD86-1436	44 lbs	WR86-1436-5	60 lbs	AD86-1436-5	54 lbs	Y Y Y Y Y
14" x 42"	WR86-1442	60 lbs	AD86-1442	52 lbs	WR86-1442-5	70 lbs	AD86-1442-5	64 lbs	Y Y Y Y Y
14" x 48"	WR86-1448	64 lbs	AD86-1448	56 lbs	WR86-1448-5	75 lbs	AD86-1448-5	69 lbs	Y Y Y Y Y
14" x 54"	WR86-1454	68 lbs	AD86-1454	60 lbs	WR86-1454-5	80 lbs	AD86-1454-5	74 lbs	Y Y Y Y Y
14" x 60"	WR86-1460	76 lbs	AD86-1460	68 lbs	WR86-1460-5	90 lbs	AD86-1460-5	84 lbs	Y Y Y Y Y
14" x 72"	WR86-1472	88 lbs	AD86-1472	80 lbs	WR86-1472-5	105 lbs	AD86-1472-5	99 lbs	Y Y Y Y Y
18" x 24"	WR86-1824	48 lbs	AD86-1824	40 lbs	WR86-1824-5	55 lbs	AD86-1824-5	49 lbs	Y Y Y Y Y
18" x 30"	WR86-1830	52 lbs	AD86-1830	44 lbs	WR86-1830-5	60 lbs	AD86-1830-5	54 lbs	Y Y Y Y Y
18" x 36"	WR86-1836	60 lbs	AD86-1836	52 lbs	WR86-1836-5	60 lbs	AD86-1836-5	64 lbs	Y Y Y Y Y
18" x 42"	WR86-1842	64 lbs	AD86-1842	56 lbs	WR86-1842-5	75 lbs	AD86-1842-5	69 lbs	Y Y Y Y Y
18" x 48"	WR86-1848	68 lbs	AD86-1848	60 lbs	WR86-1848-5	82 lbs	AD86-1848-5	76 lbs	Y Y Y Y Y
18" x 54"	WR86-1854	80 lbs	AD86-1854	72 lbs	WR86-1854-5	95 lbs	AD86-1854-5	89 lbs	Y Y Y Y Y
18" x 60"	WR86-1860	88 lbs	AD86-1860	80 lbs	WR86-1860-5	105 lbs	AD86-1860-5	99 lbs	Y Y Y Y Y
18" x 72"	WR86-1872	100 lbs	AD86-1872	92 lbs	WR86-1872-5	120 lbs	AD86-1872-5	114 lbs	Y Y Y Y Y
21" x 24"	WR86-2124	52 lbs	AD86-2124	44 lbs	WR86-2124-5	60 lbs	AD86-2124-5	54 lbs	Y Y Y Y Y
21" x 30"	WR86-2130	56 lbs	AD86-2130	48 lbs	WR86-2130-5	65 lbs	AD86-2130-5	59 lbs	Y Y Y Y Y
21" x 36"	WR86-2136	64 lbs	AD86-2136	56 lbs	WR86-2136-5	75 lbs	AD86-2136-5	69 lbs	Y Y Y Y Y
21" x 42"	WR86-2142	68 lbs	AD86-2142	60 lbs	WR86-2142-5	80 lbs	AD86-2142-5	74 lbs	Y Y Y Y Y
21" x 48"	WR86-2148	76 lbs	AD86-2148	68 lbs	WR86-2148-5	90 lbs	AD86-2148-5	84 lbs	Y Y Y Y Y
21" x 54"	WR86-2154	84 lbs	AD86-2154	76 lbs	WR86-2154-5	100 lbs	AD86-2154-5	94 lbs	Y Y Y Y Y
21" x 60"	WR86-2160	92 lbs	AD86-2160	84 lbs	WR86-2160-5	110 lbs	AD86-2160-5	104 lbs	Y Y Y Y Y
21" x 72"	WR86-2172	116 lbs	AD86-2172	108 lbs	WR86-2172-5	140 lbs	AD86-2172-5	134 lbs	Y Y Y Y Y
24" x 24"	WR86-2424	56 lbs	AD86-2424	48 lbs	WR86-2424-5	65 lbs	AD86-2424-5	59 lbs	Y Y Y Y Y
24" x 30"	WR86-2430	64 lbs	AD86-2430	56 lbs	WR86-2430-5	75 lbs	AD86-2430-5	69 lbs	Y Y Y Y Y
24" x 36"	WR86-2436	72 lbs	AD86-2436	64 lbs	WR86-2436-5	85 lbs	AD86-2436-5	79 lbs	Y Y Y Y Y
24" x 42"	WR86-2442	80 lbs	AD86-2442	72 lbs	WR86-2442-5	95 lbs	AD86-2442-5	89 lbs	Y Y Y Y Y
24" x 48"	WR86-2448	84 lbs	AD86-2448	76 lbs	WR86-2448-5	100 lbs	AD86-2448-5	94 lbs	Y Y Y Y Y
24" x 54"	WR86-2454	92 lbs	AD86-2454	84 lbs	WR86-2454-5	110 lbs	AD86-2454-5	104 lbs	Y Y Y Y Y
24" x 60"	WR86-2460	104 lbs	AD86-2460	96 lbs	WR86-2460-5	125 lbs	AD86-2460-5	119 lbs	Y Y Y Y Y
24" x 72"	WR86-2472	124 lbs	AD86-2472	116 lbs	WR86-2472-5	150 lbs	AD86-2472-5	144 lbs	Y Y Y Y Y
30" x 36"	WR86-3036	80 lbs	AD86-3036	72 lbs	WR86-3036-5	95 lbs	AD86-3036-5	89 lbs	Y Y Y Y Y
30" x 42"	WR86-3042	92 lbs	AD86-3042	84 lbs	WR86-3042-5	110 lbs	AD86-3042-5	104 lbs	Y Y Y Y Y
30" x 48"	WR86-3048	104 lbs	AD86-3048	96 lbs	WR86-3048-5	125 lbs	AD86-3048-5	119 lbs	Y Y Y Y Y
30" x 60"	WR86-3060	128 lbs	AD86-3060	120 lbs	WR86-3060-5	155 lbs	AD86-3060-5	149 lbs	Y Y Y Y Y
30" x 72"	WR86-3072	144 lbs	AD86-3072	136 lbs	WR86-3072-5	175 lbs	AD86-3072-5	169 lbs	Y Y Y Y Y
36" x 36"	WR86-3636	92 lbs	AD86-3636	84 lbs	WR86-3636-5	110 lbs	AD86-3636-5	104 lbs	Y Y Y Y Y
36" x 48"	WR86-3648	112 lbs	AD86-3648	104 lbs	WR86-3648-5	135 lbs	AD86-3648-5	129 lbs	Y Y Y Y Y
36" x 60"	WR86-3660	136 lbs	AD86-3660	128 lbs	WR86-3660-5	165 lbs	AD86-3660-5	159 lbs	Y Y Y Y Y
36" x 72"	WR86-3672	144 lbs	AD86-3672	136 lbs	WR86-3672-5	179 lbs	AD86-3672-5	173 lbs	Y Y Y Y Y

Shelving units include 4 posts and 4 or 5 shelves. Add-On units include 2 posts, 4 or 5 shelves and 8 or 10 S-Hooks. Y (Yes) N (No)

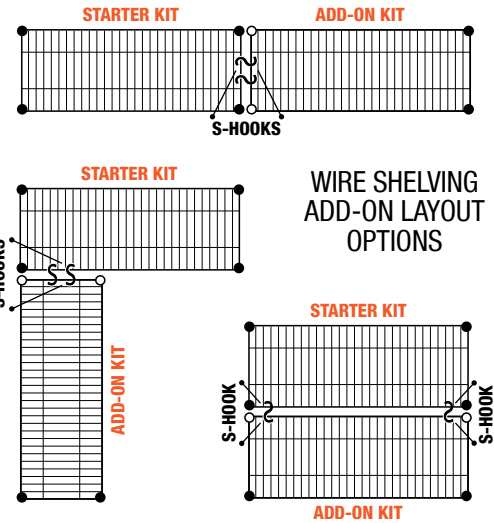

**S-HOOK**  
For continuous runs of shelving. Two hooks should be placed per shelf where two posts are not utilized. For available finishes, see **pg. 166**



## SOLID SHELVING - NO SPILL SURFACE

The solid steel design of these shelves is ideal for storage of small parts that might normally fall through wire shelves. Dual layer construction with double hemmed perimeter and marine edge ensures maximum strength while retaining spillage and excellent corrosion resistance.

All welded solid shelves are constructed of 18 gauge galvanized steel or 304 stainless steel.

By using various accessories, hundreds of shelving configurations become possible.



**18 GAUGE GALVANIZED**



**Galvanized** - is known as a hot-dipping process in which the steel is dipped in molten zinc. This extra layer adds corrosion resistance to the finalized product. Recommended to be used in any application in a dry storage environment. 1-year limited warranty.



**304 STAINLESS STEEL**



**Stainless Steel** - 304 Stainless with an electro-polish finish represents the highest industry standard in the prevention of corrosion. This finish is highly effective for corrosive, high humidity or clean room environments. Lifetime warranty for 304 stainless steel electro-polish finish.

**UNITS CAN BE LOADED/UNLOADED EASILY FROM ALL SIDES.**

**Solid Shelves**



- Designed for storage of small parts that might normally fall through wire shelves
- Dual layer construction with double hemmed perimeter with marine edge ensures maximum strength while retaining spillage and excellent corrosion resistance

DIMENSIONS W" x L"	SHIP WGT	GALVANIZED STEEL	STAINLESS STEEL
		MODEL NO.	MODEL NO.
<b>14" Deep - Solid Shelves</b>			
14" x 30"	13 lbs	-	<b>1430SS</b>
14" x 36"	14 lbs	<b>1436SG</b>	<b>1436SS</b>
14" x 42"	15 lbs	<b>1442SG</b>	<b>1442SS</b>
14" x 48"	17 lbs	<b>1448SG</b>	<b>1448SS</b>
14" x 54"	20 lbs	<b>1454SG</b>	<b>1454SS</b>
14" x 60"	22 lbs	<b>1460SG</b>	<b>1460SS</b>
14" x 72"	26 lbs	<b>1472SG</b>	<b>1472SS</b>
<b>18" Deep - Solid Shelves</b>			
18" x 24"	11 lbs	<b>1824SG</b>	<b>1824SS</b>
18" x 30"	14 lbs	<b>1830SG</b>	<b>1830SS</b>
18" x 36"	16 lbs	<b>1836SG</b>	<b>1836SS</b>
18" x 42"	18 lbs	<b>1842SG</b>	<b>1842SS</b>
18" x 48"	20 lbs	<b>1848SG</b>	<b>1848SS</b>
18" x 54"	22 lbs	<b>1854SG</b>	<b>1854SS</b>
18" x 60"	24 lbs	<b>1860SG</b>	<b>1860SS</b>
18" x 72"	27 lbs	<b>1872SG</b>	<b>1872SS</b>
<b>21" Deep - Solid Shelves</b>			
21" x 24"	13 lbs	<b>2124SG</b>	<b>2124SS</b>
21" x 30"	15 lbs	<b>2130SG</b>	<b>2130SS</b>
21" x 36"	18 lbs	<b>2136SG</b>	<b>2136SS</b>
21" x 42"	21 lbs	<b>2142SG</b>	<b>2142SS</b>
21" x 48"	23 lbs	<b>2148SG</b>	<b>2148SS</b>
21" x 54"	25 lbs	<b>2154SG</b>	<b>2154SS</b>
21" x 60"	28 lbs	<b>2160SG</b>	<b>2160SS</b>
21" x 72"	30 lbs	<b>2172SG</b>	<b>2172SS</b>
<b>24" Deep - Solid Shelves</b>			
24" x 24"	15 lbs	<b>2424SG</b>	<b>2424SS</b>
24" x 30"	17 lbs	<b>2430SG</b>	<b>2430SS</b>
24" x 36"	19 lbs	<b>2436SG</b>	<b>2436SS</b>
24" x 42"	22 lbs	<b>2442SG</b>	<b>2442SS</b>
24" x 48"	24 lbs	<b>2448SG</b>	<b>2448SS</b>
24" x 54"	26 lbs	<b>2454SG</b>	<b>2454SS</b>
24" x 60"	31 lbs	<b>2460SG</b>	<b>2460SS</b>
24" x 72"	34 lbs	<b>2472SG</b>	<b>2472SS</b>

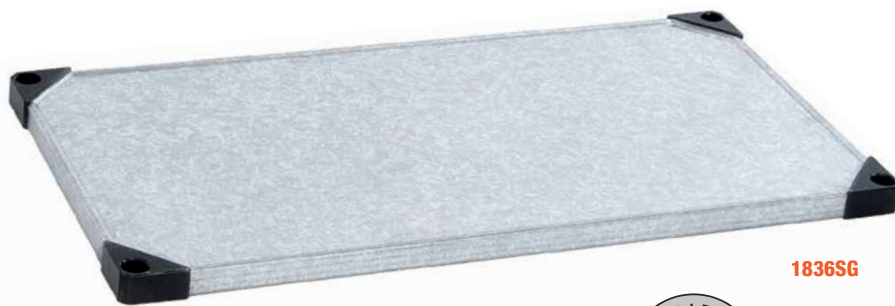

1836SG

**18 GAUGE**  
GALVANIZED



1836SS

**304**  
STAINLESS STEEL



**Up to 400-600 lb.**  
LOAD CAPACITY PER SHELF

**EASY IDENTIFICATION OF AISLES/ROWS CONTENTS**

**Posts**



All posts are fabricated from 16 gauge carbon steel with location grooves on one inch increments and ease for shelf installation. Numbers are printed between grooves for quick assembly. Posts are double grooved in consistent intervals for quick identification. Leveling legs are enclosed with all posts. Leveling legs cannot be used in conjunction with stem casters. Custom post heights are available, call for additional information.

DESCRIPTION	SHIP WGT	CHROME	STAINLESS STEEL
		MODEL NO.	MODEL NO.
6"H Post	1 lb	<b>P6C</b>	<b>P6S</b>
14"H Post	1 lb	<b>P14C</b>	<b>P14S</b>
34"H Post	2 lbs	<b>P34C</b>	<b>P34S</b>
36"H Post	2 lbs	<b>P36C</b>	-
39"H Post	2 lbs	<b>P39C</b>	-
42"H Post	2 lbs	-	<b>P42S</b>
54"H Post	3 lbs	<b>P54C</b>	<b>P54S</b>
63"H Post	4 lbs	<b>P63C*</b>	<b>P63S</b>
74"H Post	4 lbs	<b>P74C*</b>	<b>P74S</b>
86"H Post	5 lbs	<b>P86C*</b>	<b>P86S</b>
96"H Post	6 lbs	<b>P96C</b>	<b>P96S</b>

\*For easy installation, 63", 74" and 86" posts are available with pre-inserted leveler and bolt by adding an **X** to the Model No. **P74CX**

**W-PC**  
Replacement Post Cap  
Additional pieces available  
(Sold as 4-pack)

**W-PC-STUD**  
Threaded Stud Connector can be utilized to connect two posts enabling any post height to be achieved. Must be used with **WR-WMB** to secure to wall

**LASER PRINTED NUMBERS**  
For quick shelf positioning

**W-PLI**  
Post Insert  
Additional pieces available  
(Sold as 4-pack)

**W-PLB**  
Post Leveler adjusts up or down allowing height flexibility  
(Sold as 4-pack)



**PLH1X6C**  
Post Label  
1" x 6"



**PLH2X4C**  
Post Label  
2" x 4"

**Post Label Holders**

New post label holders come in two sizes and allow for easy identification of aisles/rows as well as of wire cart contents. Attach to standard 1" diameter posts. Each package includes 12 clear holders and corresponding printer friendly sheet labels.

MODEL NO.	DIMENSIONS W" x L"	PKG QTY	SHIP WGT
<b>PLH1X6C</b>	1" x 6"	12 pcs	1 lb
<b>PLH2X4C</b>	2" x 4"	12 pcs	1 lb

**4 Shelf Starter Kits**

Solid flat shelves allows for storage from small to large items, and the marine edge perimeter prevents spillage. The double hemmed 18 gauge galvanized steel provides the solid shelf excellent strength characteristics. All solid shelf units consist of 4 shelves and 4 posts. Mobilize starter kit shelving unit using optional mobile kit WR-00H, see pg. 167. *Finish:* Galvanized Steel



**MOBILIZE YOUR SHELVING**

**DB - Donut Bumper**

Non-marking donut bumper used to protect walls and help cushion impact.

**WR-00H (Mobile Kit)\***

Set of four swivel thermoplastic resin 5" x 1-1/4" casters, two with brakes. Can be used with all units shown. Up to 1,200 lb. load capacity. \*Mobile kits recommended only for shelves 18" and deeper.



**4 SHELF STARTER KIT**



**QSMC Shelf Clamp**  
Shelf Clamp eliminates 2 posts per shelving section. Two QSMC clamps are required per shelf. *Finish:* Aluminum (Sold individually)

54" H - GALVANIZED SOLID SHELVING 4 SHELVES					63" H - GALVANIZED SOLID SHELVING 4 SHELVES				
STARTER KIT			ADD-ON KIT		STARTER KIT			ADD-ON KIT	
SHELF W" x L"	MODEL NO.	SHIP WGT	MODEL NO.	SHIP WGT	MODEL NO.	SHIP WGT	MODEL NO.	SHIP WGT	
14" x 36"	WR54-1436SG	68 lbs	AD54-1436SG	65 lbs	WR63-1436SG	72 lbs	AD63-1436SG	67 lbs	
14" x 42"	WR54-1442SG	72 lbs	AD54-1442SG	69 lbs	WR63-1442SG	76 lbs	AD63-1442SG	71 lbs	
14" x 48"	WR54-1448SG	80 lbs	AD54-1448SG	77 lbs	WR63-1448SG	84 lbs	AD63-1448SG	79 lbs	
14" x 54"	WR54-1454SG	92 lbs	AD54-1454SG	89 lbs	WR63-1454SG	96 lbs	AD63-1454SG	91 lbs	
14" x 60"	WR54-1460SG	100 lbs	AD54-1460SG	97 lbs	WR63-1460SG	104 lbs	AD63-1460SG	99 lbs	
14" x 72"	WR54-1472SG	116 lbs	AD54-1472SG	113 lbs	WR63-1472SG	120 lbs	AD63-1472SG	115 lbs	
18" x 24"	WR54-1824SG	56 lbs	AD54-1824SG	53 lbs	WR63-1824SG	60 lbs	AD63-1824SG	55 lbs	
18" x 30"	WR54-1830SG	68 lbs	AD54-1830SG	65 lbs	WR63-1830SG	72 lbs	AD63-1830SG	67 lbs	
18" x 36"	WR54-1836SG	76 lbs	AD54-1836SG	73 lbs	WR63-1836SG	80 lbs	AD63-1836SG	75 lbs	
18" x 42"	WR54-1842SG	84 lbs	AD54-1842SG	81 lbs	WR63-1842SG	88 lbs	AD63-1842SG	83 lbs	
18" x 48"	WR54-1848SG	92 lbs	AD54-1848SG	89 lbs	WR63-1848SG	96 lbs	AD63-1848SG	91 lbs	
18" x 54"	WR54-1854SG	100 lbs	AD54-1854SG	97 lbs	WR63-1854SG	104 lbs	AD63-1854SG	99 lbs	
18" x 60"	WR54-1860SG	108 lbs	AD54-1860SG	105 lbs	WR63-1860SG	112 lbs	AD63-1860SG	107 lbs	
18" x 72"	WR54-1872SG	120 lbs	AD54-1872SG	117 lbs	WR63-1872SG	124 lbs	AD63-1872SG	119 lbs	
21" x 24"	WR54-2124SG	64 lbs	AD54-2124SG	61 lbs	WR63-2124SG	68 lbs	AD63-2124SG	63 lbs	
21" x 30"	WR54-2130SG	72 lbs	AD54-2130SG	69 lbs	WR63-2130SG	76 lbs	AD63-2130SG	71 lbs	
21" x 36"	WR54-2136SG	84 lbs	AD54-2136SG	81 lbs	WR63-2136SG	88 lbs	AD63-2136SG	83 lbs	
21" x 42"	WR54-2142SG	96 lbs	AD54-2142SG	93 lbs	WR63-2142SG	100 lbs	AD63-2142SG	95 lbs	
21" x 48"	WR54-2148SG	104 lbs	AD54-2148SG	101 lbs	WR63-2148SG	108 lbs	AD63-2148SG	103 lbs	
21" x 54"	WR54-2154SG	112 lbs	AD54-2154SG	109 lbs	WR63-2154SG	116 lbs	AD63-2154SG	111 lbs	
21" x 60"	WR54-2160SG	124 lbs	AD54-2160SG	121 lbs	WR63-2160SG	128 lbs	AD63-2160SG	123 lbs	
21" x 72"	WR54-2172SG	132 lbs	AD54-2172SG	129 lbs	WR63-2172SG	136 lbs	AD63-2172SG	131 lbs	
24" x 24"	WR54-2424SG	72 lbs	AD54-2424SG	69 lbs	WR63-2424SG	76 lbs	AD63-2424SG	71 lbs	
24" x 30"	WR54-2430SG	80 lbs	AD54-2430SG	77 lbs	WR63-2430SG	84 lbs	AD63-2430SG	79 lbs	
24" x 36"	WR54-2436SG	88 lbs	AD54-2436SG	85 lbs	WR63-2436SG	92 lbs	AD63-2436SG	87 lbs	
24" x 42"	WR54-2442SG	100 lbs	AD54-2442SG	97 lbs	WR63-2442SG	104 lbs	AD63-2442SG	99 lbs	
24" x 48"	WR54-2448SG	108 lbs	AD54-2448SG	105 lbs	WR63-2448SG	112 lbs	AD63-2448SG	107 lbs	
24" x 54"	WR54-2454SG	124 lbs	AD54-2454SG	121 lbs	WR63-2454SG	128 lbs	AD63-2454SG	123 lbs	
24" x 60"	WR54-2460SG	136 lbs	AD54-2460SG	133 lbs	WR63-2460SG	140 lbs	AD63-2460SG	135 lbs	
24" x 72"	WR54-2472SG	148 lbs	AD54-2472SG	145 lbs	WR63-2472SG	152 lbs	AD63-2472SG	147 lbs	

Shelving units include 4 posts and 4 shelves. Add-On units include 2 posts, 4 shelves and 8 shelf clamps.

**18 GAUGE GALVANIZED STEEL**

**Up to 400-600 lb. LOAD CAPACITY PER SHELF EVENLY DISTRIBUTED**

**4 Shelf Add-On Kits**

Additional Add-On kits allow you to expand your Starter kit by sharing a set of posts. Configuration options include side to side, back to back and right angles (L-Shape). Add-on units consist of 4 shelves, 2 posts and 8 shelf clamps. Additional shelves and posts may be purchased separately, see chart on pg. 111. Units with Add-On kit cannot be made mobile. *Finish:* Galvanized Steel

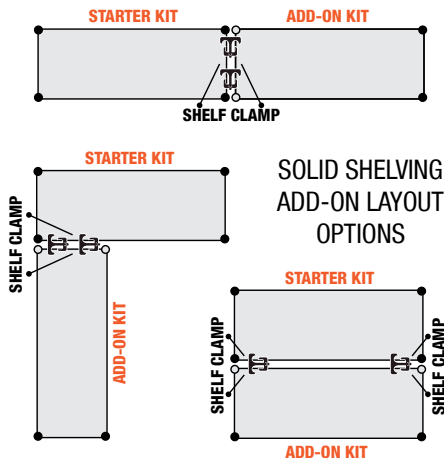

74" H - GALVANIZED SOLID SHELVING 4 SHELVES					86" H - GALVANIZED SOLID SHELVING 4 SHELVES				
STARTER KIT			ADD-ON KIT		STARTER KIT			ADD-ON KIT	
SHELF W" x L"	MODEL NO.	SHIP WGT	MODEL NO.	SHIP WGT	MODEL NO.	SHIP WGT	MODEL NO.	SHIP WGT	
14" x 36"	WR74-1436SG	72 lbs	AD74-1436SG	67 lbs	WR86-1436SG	76 lbs	AD86-1436SG	69 lbs	
14" x 42"	WR74-1442SG	76 lbs	AD74-1442SG	71 lbs	WR86-1442SG	80 lbs	AD86-1442SG	73 lbs	
14" x 48"	WR74-1448SG	84 lbs	AD74-1448SG	79 lbs	WR86-1448SG	88 lbs	AD86-1448SG	81 lbs	
14" x 54"	WR74-1454SG	96 lbs	AD74-1454SG	91 lbs	WR86-1454SG	100 lbs	AD86-1454SG	93 lbs	
14" x 60"	WR74-1460SG	104 lbs	AD74-1460SG	99 lbs	WR86-1460SG	108 lbs	AD86-1460SG	101 lbs	
14" x 72"	WR74-1472SG	120 lbs	AD74-1472SG	115 lbs	WR86-1472SG	124 lbs	AD86-1472SG	117 lbs	
18" x 24"	WR74-1824SG	60 lbs	AD74-1824SG	55 lbs	WR86-1824SG	64 lbs	AD86-1824SG	57 lbs	
18" x 30"	WR74-1830SG	72 lbs	AD74-1830SG	67 lbs	WR86-1830SG	76 lbs	AD86-1830SG	69 lbs	
18" x 36"	WR74-1836SG	80 lbs	AD74-1836SG	75 lbs	WR86-1836SG	84 lbs	AD86-1836SG	77 lbs	
18" x 42"	WR74-1842SG	88 lbs	AD74-1842SG	83 lbs	WR86-1842SG	92 lbs	AD86-1842SG	85 lbs	
18" x 48"	WR74-1848SG	96 lbs	AD74-1848SG	91 lbs	WR86-1848SG	100 lbs	AD86-1848SG	93 lbs	
18" x 54"	WR74-1854SG	104 lbs	AD74-1854SG	99 lbs	WR86-1854SG	108 lbs	AD86-1854SG	101 lbs	
18" x 60"	WR74-1860SG	112 lbs	AD74-1860SG	107 lbs	WR86-1860SG	116 lbs	AD86-1860SG	109 lbs	
18" x 72"	WR74-1872SG	124 lbs	AD74-1872SG	119 lbs	WR86-1872SG	128 lbs	AD86-1872SG	121 lbs	
21" x 24"	WR74-2124SG	68 lbs	AD74-2124SG	63 lbs	WR86-2124SG	72 lbs	AD86-2124SG	65 lbs	
21" x 30"	WR74-2130SG	76 lbs	AD74-2130SG	71 lbs	WR86-2130SG	80 lbs	AD86-2130SG	73 lbs	
21" x 36"	WR74-2136SG	88 lbs	AD74-2136SG	83 lbs	WR86-2136SG	92 lbs	AD86-2136SG	85 lbs	
21" x 42"	WR74-2142SG	100 lbs	AD74-2142SG	95 lbs	WR86-2142SG	104 lbs	AD86-2142SG	97 lbs	
21" x 48"	WR74-2148SG	108 lbs	AD74-2148SG	103 lbs	WR86-2148SG	112 lbs	AD86-2148SG	105 lbs	
21" x 54"	WR74-2154SG	116 lbs	AD74-2154SG	111 lbs	WR86-2154SG	120 lbs	AD86-2154SG	113 lbs	
21" x 60"	WR74-2160SG	128 lbs	AD74-2160SG	123 lbs	WR86-2160SG	132 lbs	AD86-2160SG	125 lbs	
21" x 72"	WR74-2172SG	136 lbs	AD74-2172SG	131 lbs	WR86-2172SG	140 lbs	AD86-2172SG	133 lbs	
24" x 24"	WR74-2424SG	76 lbs	AD74-2424SG	71 lbs	WR86-2424SG	80 lbs	AD86-2424SG	73 lbs	
24" x 30"	WR74-2430SG	84 lbs	AD74-2430SG	79 lbs	WR86-2430SG	88 lbs	AD86-2430SG	81 lbs	
24" x 36"	WR74-2436SG	92 lbs	AD74-2436SG	87 lbs	WR86-2436SG	96 lbs	AD86-2436SG	89 lbs	
24" x 42"	WR74-2442SG	104 lbs	AD74-2442SG	99 lbs	WR86-2442SG	108 lbs	AD86-2442SG	101 lbs	
24" x 48"	WR74-2448SG	112 lbs	AD74-2448SG	107 lbs	WR86-2448SG	116 lbs	AD86-2448SG	109 lbs	
24" x 54"	WR74-2454SG	128 lbs	AD74-2454SG	123 lbs	WR86-2454SG	132 lbs	AD86-2454SG	125 lbs	
24" x 60"	WR74-2460SG	140 lbs	AD74-2460SG	135 lbs	WR86-2460SG	144 lbs	AD86-2460SG	137 lbs	
24" x 72"	WR74-2472SG	152 lbs	AD74-2472SG	147 lbs	WR86-2472SG	156 lbs	AD86-2472SG	149 lbs	

Shelving units include 4 posts and 4 shelves. Add-On units include 2 posts, 4 shelves and 8 shelf clamps.



**LOWEST PRICE**  
GUARANTEE

**54" H - GALVANIZED SOLID SHELVING 5 SHELVES**      **63" H - GALVANIZED SOLID SHELVING 5 SHELVES**

STARTER KIT			ADD-ON KIT		STARTER KIT			ADD-ON KIT	
SHELF W" x L"	MODEL NO.	SHIP WGT	MODEL NO.	SHIP WGT	MODEL NO.	SHIP WGT	MODEL NO.	SHIP WGT	
14" x 36"	WR54-1436SG-5	82 lbs	AD54-1436SG-5	79 lbs	WR63-1436SG-5	86 lbs	AD63-1436SG-5	81 lbs	
14" x 42"	WR54-1442SG-5	87 lbs	AD54-1442SG-5	84 lbs	WR63-1442SG-5	91 lbs	AD63-1442SG-5	86 lbs	
14" x 48"	WR54-1448SG-5	97 lbs	AD54-1448SG-5	94 lbs	WR63-1448SG-5	101 lbs	AD63-1448SG-5	96 lbs	
14" x 54"	WR54-1454SG-5	112 lbs	AD54-1454SG-5	109 lbs	WR63-1454SG-5	116 lbs	AD63-1454SG-5	111 lbs	
14" x 60"	WR54-1460SG-5	122 lbs	AD54-1460SG-5	119 lbs	WR63-1460SG-5	126 lbs	AD63-1460SG-5	121 lbs	
14" x 72"	WR54-1472SG-5	142 lbs	AD54-1472SG-5	139 lbs	WR63-1472SG-5	146 lbs	AD63-1472SG-5	141 lbs	
18" x 24"	WR54-1824SG-5	67 lbs	AD54-1824SG-5	64 lbs	WR63-1824SG-5	71 lbs	AD63-1824SG-5	66 lbs	
18" x 30"	WR54-1830SG-5	82 lbs	AD54-1830SG-5	79 lbs	WR63-1830SG-5	86 lbs	AD63-1830SG-5	81 lbs	
18" x 36"	WR54-1836SG-5	92 lbs	AD54-1836SG-5	89 lbs	WR63-1836SG-5	96 lbs	AD63-1836SG-5	91 lbs	
18" x 42"	WR54-1842SG-5	102 lbs	AD54-1842SG-5	99 lbs	WR63-1842SG-5	106 lbs	AD63-1842SG-5	101 lbs	
18" x 48"	WR54-1848SG-5	112 lbs	AD54-1848SG-5	109 lbs	WR63-1848SG-5	116 lbs	AD63-1848SG-5	111 lbs	
18" x 54"	WR54-1854SG-5	122 lbs	AD54-1854SG-5	119 lbs	WR63-1854SG-5	126 lbs	AD63-1854SG-5	121 lbs	
18" x 60"	WR54-1860SG-5	132 lbs	AD54-1860SG-5	129 lbs	WR63-1860SG-5	136 lbs	AD63-1860SG-5	131 lbs	
18" x 72"	WR54-1872SG-5	147 lbs	AD54-1872SG-5	144 lbs	WR63-1872SG-5	151 lbs	AD63-1872SG-5	146 lbs	
21" x 24"	WR54-2124SG-5	77 lbs	AD54-2124SG-5	74 lbs	WR63-2124SG-5	81 lbs	AD63-2124SG-5	76 lbs	
21" x 30"	WR54-2130SG-5	87 lbs	AD54-2130SG-5	84 lbs	WR63-2130SG-5	91 lbs	AD63-2130SG-5	86 lbs	
21" x 36"	WR54-2136SG-5	102 lbs	AD54-2136SG-5	99 lbs	WR63-2136SG-5	106 lbs	AD63-2136SG-5	101 lbs	
21" x 42"	WR54-2142SG-5	117 lbs	AD54-2142SG-5	114 lbs	WR63-2142SG-5	121 lbs	AD63-2142SG-5	116 lbs	
21" x 48"	WR54-2148SG-5	127 lbs	AD54-2148SG-5	124 lbs	WR63-2148SG-5	131 lbs	AD63-2148SG-5	126 lbs	
21" x 54"	WR54-2154SG-5	137 lbs	AD54-2154SG-5	134 lbs	WR63-2154SG-5	141 lbs	AD63-2154SG-5	136 lbs	
21" x 60"	WR54-2160SG-5	152 lbs	AD54-2160SG-5	149 lbs	WR63-2160SG-5	156 lbs	AD63-2160SG-5	151 lbs	
21" x 72"	WR54-2172SG-5	162 lbs	AD54-2172SG-5	159 lbs	WR63-2172SG-5	166 lbs	AD63-2172SG-5	161 lbs	
24" x 24"	WR54-2424SG-5	87 lbs	AD54-2424SG-5	84 lbs	WR63-2424SG-5	91 lbs	AD63-2424SG-5	86 lbs	
24" x 30"	WR54-2430SG-5	97 lbs	AD54-2430SG-5	94 lbs	WR63-2430SG-5	101 lbs	AD63-2430SG-5	96 lbs	
24" x 36"	WR54-2436SG-5	107 lbs	AD54-2436SG-5	104 lbs	WR63-2436SG-5	111 lbs	AD63-2436SG-5	106 lbs	
24" x 42"	WR54-2442SG-5	122 lbs	AD54-2442SG-5	119 lbs	WR63-2442SG-5	126 lbs	AD63-2442SG-5	121 lbs	
24" x 48"	WR54-2448SG-5	132 lbs	AD54-2448SG-5	129 lbs	WR63-2448SG-5	136 lbs	AD63-2448SG-5	131 lbs	
24" x 54"	WR54-2454SG-5	152 lbs	AD54-2454SG-5	149 lbs	WR63-2454SG-5	156 lbs	AD63-2454SG-5	151 lbs	
24" x 60"	WR54-2460SG-5	167 lbs	AD54-2460SG-5	164 lbs	WR63-2460SG-5	171 lbs	AD63-2460SG-5	166 lbs	
24" x 72"	WR54-2472SG-5	182 lbs	AD54-2472SG-5	179 lbs	WR63-2472SG-5	186 lbs	AD63-2472SG-5	181 lbs	

Shelving units include 4 posts and 5 shelves. Add-On units include 2 posts, 5 shelves and 10 shelf clamps.

**18 GAUGE GALVANIZED STEEL**      **Up to 400-600 lb. LOAD CAPACITY PER SHELF EVENLY DISTRIBUTED**

**74" H - GALVANIZED SOLID SHELVING 5 SHELVES**      **86" H - GALVANIZED SOLID SHELVING 5 SHELVES**

STARTER KIT			ADD-ON KIT		STARTER KIT			ADD-ON KIT	
SHELF W" x L"	MODEL NO.	SHIP WGT	MODEL NO.	SHIP WGT	MODEL NO.	SHIP WGT	MODEL NO.	SHIP WGT	
14" x 36"	WR74-1436SG-5	86 lbs	AD74-1436SG-5	81 lbs	WR86-1436SG-5	90 lbs	AD86-1436SG-5	83 lbs	
14" x 42"	WR74-1442SG-5	91 lbs	AD74-1442SG-5	86 lbs	WR86-1442SG-5	95 lbs	AD86-1442SG-5	88 lbs	
14" x 48"	WR74-1448SG-5	101 lbs	AD74-1448SG-5	91 lbs	WR86-1448SG-5	105 lbs	AD86-1448SG-5	98 lbs	
14" x 54"	WR74-1454SG-5	116 lbs	AD74-1454SG-5	111 lbs	WR86-1454SG-5	120 lbs	AD86-1454SG-5	113 lbs	
14" x 60"	WR74-1460SG-5	126 lbs	AD74-1460SG-5	121 lbs	WR86-1460SG-5	130 lbs	AD86-1460SG-5	123 lbs	
14" x 72"	WR74-1472SG-5	146 lbs	AD74-1472SG-5	141 lbs	WR86-1472SG-5	150 lbs	AD86-1472SG-5	143 lbs	
18" x 24"	WR74-1824SG-5	71 lbs	AD74-1824SG-5	66 lbs	WR86-1824SG-5	75 lbs	AD86-1824SG-5	68 lbs	
18" x 30"	WR74-1830SG-5	86 lbs	AD74-1830SG-5	81 lbs	WR86-1830SG-5	90 lbs	AD86-1830SG-5	83 lbs	
18" x 36"	WR74-1836SG-5	96 lbs	AD74-1836SG-5	91 lbs	WR86-1836SG-5	100 lbs	AD86-1836SG-5	93 lbs	
18" x 42"	WR74-1842SG-5	106 lbs	AD74-1842SG-5	101 lbs	WR86-1842SG-5	110 lbs	AD86-1842SG-5	103 lbs	
18" x 48"	WR74-1848SG-5	116 lbs	AD74-1848SG-5	111 lbs	WR86-1848SG-5	120 lbs	AD86-1848SG-5	113 lbs	
18" x 54"	WR74-1854SG-5	126 lbs	AD74-1854SG-5	121 lbs	WR86-1854SG-5	130 lbs	AD86-1854SG-5	123 lbs	
18" x 60"	WR74-1860SG-5	136 lbs	AD74-1860SG-5	131 lbs	WR86-1860SG-5	140 lbs	AD86-1860SG-5	133 lbs	
18" x 72"	WR74-1872SG-5	151 lbs	AD74-1872SG-5	151 lbs	WR86-1872SG-5	155 lbs	AD86-1872SG-5	153 lbs	
21" x 24"	WR74-2124SG-5	81 lbs	AD74-2124SG-5	76 lbs	WR86-2124SG-5	85 lbs	AD86-2124SG-5	78 lbs	
21" x 30"	WR74-2130SG-5	91 lbs	AD74-2130SG-5	86 lbs	WR86-2130SG-5	95 lbs	AD86-2130SG-5	88 lbs	
21" x 36"	WR74-2136SG-5	106 lbs	AD74-2136SG-5	101 lbs	WR86-2136SG-5	110 lbs	AD86-2136SG-5	103 lbs	
21" x 42"	WR74-2142SG-5	121 lbs	AD74-2142SG-5	116 lbs	WR86-2142SG-5	125 lbs	AD86-2142SG-5	118 lbs	
21" x 48"	WR74-2148SG-5	131 lbs	AD74-2148SG-5	126 lbs	WR86-2148SG-5	135 lbs	AD86-2148SG-5	123 lbs	
21" x 54"	WR74-2154SG-5	141 lbs	AD74-2154SG-5	136 lbs	WR86-2154SG-5	145 lbs	AD86-2154SG-5	138 lbs	
21" x 60"	WR74-2160SG-5	156 lbs	AD74-2160SG-5	151 lbs	WR86-2160SG-5	160 lbs	AD86-2160SG-5	153 lbs	
21" x 72"	WR74-2172SG-5	166 lbs	AD74-2172SG-5	166 lbs	WR86-2172SG-5	170 lbs	AD86-2172SG-5	168 lbs	
24" x 24"	WR74-2424SG-5	91 lbs	AD74-2424SG-5	86 lbs	WR86-2424SG-5	95 lbs	AD86-2424SG-5	88 lbs	
24" x 30"	WR74-2430SG-5	101 lbs	AD74-2430SG-5	96 lbs	WR86-2430SG-5	105 lbs	AD86-2430SG-5	98 lbs	
24" x 36"	WR74-2436SG-5	111 lbs	AD74-2436SG-5	106 lbs	WR86-2436SG-5	115 lbs	AD86-2436SG-5	108 lbs	
24" x 42"	WR74-2442SG-5	126 lbs	AD74-2442SG-5	121 lbs	WR86-2442SG-5	130 lbs	AD86-2442SG-5	123 lbs	
24" x 48"	WR74-2448SG-5	136 lbs	AD74-2448SG-5	131 lbs	WR86-2448SG-5	140 lbs	AD86-2448SG-5	133 lbs	
24" x 54"	WR74-2454SG-5	156 lbs	AD74-2454SG-5	151 lbs	WR86-2454SG-5	160 lbs	AD86-2454SG-5	153 lbs	
24" x 60"	WR74-2460SG-5	171 lbs	AD74-2460SG-5	166 lbs	WR86-2460SG-5	175 lbs	AD86-2460SG-5	168 lbs	
24" x 72"	WR74-2472SG-5	186 lbs	AD74-2472SG-5	181 lbs	WR86-2472SG-5	205 lbs	AD86-2472SG-5	198 lbs	

Shelving units include 4 posts and 5 shelves. Add-On units include 2 posts, 5 shelves and 10 shelf clamps.

**5 Shelf Starter Kits**

Solid flat shelves allows for storage from small to large items, and the marine edge perimeter prevents spillage. The double hemmed 18 gauge galvanized steel gives the solid shelf excellent strength characteristics. All solid shelf units consist of 5 shelves and 4 posts. Mobilize starter kit shelving unit using optional mobile kit WR-00H, see pg. 167. *Finish: Galvanized Steel*



**MOBILIZE YOUR SHELVING**

**DB - Donut Bumper**  
Non-marking donut bumper used to protect walls and help cushion impact.

**WR-00H (Mobile Kit)\***  
Set of four swivel thermoplastic resin 5" x 1-1/4" casters, two with brakes. Can be used with all units shown. Up to 1,200 lb. load capacity. \*Mobile kits recommended only for shelves 18" and deeper.



**QSMC Shelf Clamp**  
Shelf Clamp eliminates 2 posts per shelving section. Two QSMC clamps are required per shelf. *Finish: Aluminum (Sold individually)*



**5 SHELF ADD-ON KIT**

**5 Shelf Add-On Kits**

Additional Add-On kit allows you to expand your Starter kit by sharing a set of posts. Configuration options include side to side, back to back and right angles (L-Shape). Add-on units consist of 5 shelves, 2 posts and 10 shelf clamps. Additional shelves and posts may be purchased separately, see chart on pg. 111. Units with Add-On kit cannot be made mobile. *Finish: Galvanized Steel*

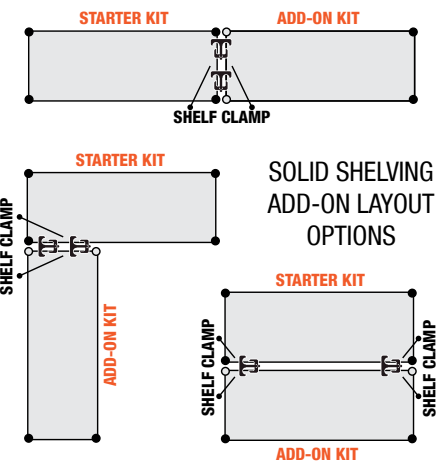

4 Shelf Starter Kits

Solid flat shelves allows for storage from small to large items, and the marine edge perimeter prevents spillage. The double hemmed 18 gauge 304 stainless steel gives the solid shelf excellent strength characteristics. All solid shelf units consist of 4 shelves and 4 posts. Mobilize starter kit shelving unit using optional mobile kit WR-00HS, see pg. 167. *Finish:* Stainless Steel



MOBILIZE YOUR SHELVING

**DB - Donut Bumper**  
Non-marking donut bumper used to protect walls and help cushion impact.

**WR-00HS (Mobile Kit)\***  
Set of four swivel 5" x 1-1/4" thermoplastic resin stainless steel casters with zerk grease fittings, 2 with brake. Can be used with all units shown. Up to 1,200 lb. load capacity. \*Mobile kits recommended only for shelves 18" and deeper.



**QSMC Shelf Clamp**  
Shelf Clamp eliminates 2 post per shelving section. Two QSMC clamps are required per shelf. *Finish:* Aluminum (Sold individually)

4 SHELF STARTER KIT

4 Shelf Add-On Kits

Additional Add-On kits allow you to expand your Starter kit by sharing a set of posts. Configuration options include side to side, back to back and right angles (L-Shape). Add-on units consist of 4 shelves, 2 posts and 8 shelf clamps. Additional shelves and posts may be purchased separately, see chart on pg. 111. Units with Add-On kit cannot be made mobile. *Finish:* Stainless Steel

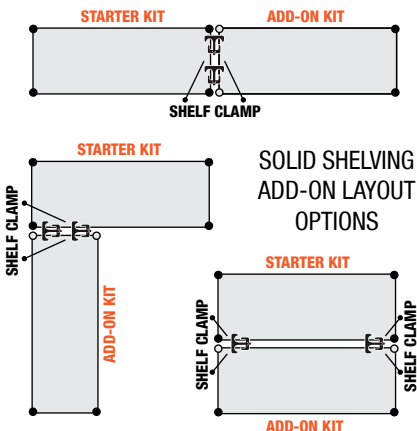

54" H - STAINLESS SOLID SHELVING 4 SHELVES				63" H - STAINLESS SOLID SHELVING 4 SHELVES					
STARTER KIT			ADD-ON KIT		STARTER KIT			ADD-ON KIT	
SHELF W" x L"	MODEL NO.	SHIP WGT	MODEL NO.	SHIP WGT	MODEL NO.	SHIP WGT	MODEL NO.	SHIP WGT	
14" x 36"	WRS4-54-1436SS	68 lbs	WRSAD4-54-1436SS	65 lbs	WRS4-63-1436SS	72 lbs	WRSAD4-63-1436SS	67 lbs	
14" x 42"	WRS4-54-1442SS	72 lbs	WRSAD4-54-1442SS	69 lbs	WRS4-63-1442SS	76 lbs	WRSAD4-63-1442SS	71 lbs	
14" x 48"	WRS4-54-1448SS	80 lbs	WRSAD4-54-1448SS	77 lbs	WRS4-63-1448SS	84 lbs	WRSAD4-63-1448SS	79 lbs	
14" x 54"	WRS4-54-1454SS	92 lbs	WRSAD4-54-1454SS	89 lbs	WRS4-63-1454SS	96 lbs	WRSAD4-63-1454SS	91 lbs	
14" x 60"	WRS4-54-1460SS	100 lbs	WRSAD4-54-1460SS	97 lbs	WRS4-63-1460SS	104 lbs	WRSAD4-63-1460SS	99 lbs	
14" x 72"	WRS4-54-1472SS	116 lbs	WRSAD4-54-1472SS	113 lbs	WRS4-63-1472SS	120 lbs	WRSAD4-63-1472SS	115 lbs	
18" x 24"	WRS4-54-1824SS	56 lbs	WRSAD4-54-1824SS	53 lbs	WRS4-63-1824SS	60 lbs	WRSAD4-63-1824SS	55 lbs	
18" x 30"	WRS4-54-1830SS	68 lbs	WRSAD4-54-1830SS	65 lbs	WRS4-63-1830SS	72 lbs	WRSAD4-63-1830SS	67 lbs	
18" x 36"	WRS4-54-1836SS	76 lbs	WRSAD4-54-1836SS	73 lbs	WRS4-63-1836SS	80 lbs	WRSAD4-63-1836SS	75 lbs	
18" x 42"	WRS4-54-1842SS	84 lbs	WRSAD4-54-1842SS	81 lbs	WRS4-63-1842SS	88 lbs	WRSAD4-63-1842SS	83 lbs	
18" x 48"	WRS4-54-1848SS	92 lbs	WRSAD4-54-1848SS	89 lbs	WRS4-63-1848SS	96 lbs	WRSAD4-63-1848SS	91 lbs	
18" x 54"	WRS4-54-1854SS	100 lbs	WRSAD4-54-1854SS	97 lbs	WRS4-63-1854SS	104 lbs	WRSAD4-63-1854SS	99 lbs	
18" x 60"	WRS4-54-1860SS	108 lbs	WRSAD4-54-1860SS	105 lbs	WRS4-63-1860SS	112 lbs	WRSAD4-63-1860SS	107 lbs	
18" x 72"	WRS4-54-1872SS	120 lbs	WRSAD4-54-1872SS	117 lbs	WRS4-63-1872SS	124 lbs	WRSAD4-63-1872SS	119 lbs	
21" x 24"	WRS4-54-2124SS	64 lbs	WRSAD4-54-2124SS	61 lbs	WRS4-63-2124SS	68 lbs	WRSAD4-63-2124SS	63 lbs	
21" x 30"	WRS4-54-2130SS	72 lbs	WRSAD4-54-2130SS	69 lbs	WRS4-63-2130SS	76 lbs	WRSAD4-63-2130SS	71 lbs	
21" x 36"	WRS4-54-2136SS	84 lbs	WRSAD4-54-2136SS	81 lbs	WRS4-63-2136SS	88 lbs	WRSAD4-63-2136SS	83 lbs	
21" x 42"	WRS4-54-2142SS	96 lbs	WRSAD4-54-2142SS	93 lbs	WRS4-63-2142SS	100 lbs	WRSAD4-63-2142SS	95 lbs	
21" x 48"	WRS4-54-2148SS	104 lbs	WRSAD4-54-2148SS	101 lbs	WRS4-63-2148SS	108 lbs	WRSAD4-63-2148SS	103 lbs	
21" x 54"	WRS4-54-2154SS	112 lbs	WRSAD4-54-2154SS	109 lbs	WRS4-63-2154SS	116 lbs	WRSAD4-63-2154SS	111 lbs	
21" x 60"	WRS4-54-2160SS	124 lbs	WRSAD4-54-2160SS	121 lbs	WRS4-63-2160SS	128 lbs	WRSAD4-63-2160SS	123 lbs	
21" x 72"	WRS4-54-2172SS	132 lbs	WRSAD4-54-2172SS	129 lbs	WRS4-63-2172SS	136 lbs	WRSAD4-63-2172SS	131 lbs	
24" x 24"	WRS4-54-2424SS	72 lbs	WRSAD4-54-2424SS	69 lbs	WRS4-63-2424SS	76 lbs	WRSAD4-63-2424SS	71 lbs	
24" x 30"	WRS4-54-2430SS	80 lbs	WRSAD4-54-2430SS	77 lbs	WRS4-63-2430SS	84 lbs	WRSAD4-63-2430SS	79 lbs	
24" x 36"	WRS4-54-2436SS	88 lbs	WRSAD4-54-2436SS	85 lbs	WRS4-63-2436SS	92 lbs	WRSAD4-63-2436SS	87 lbs	
24" x 42"	WRS4-54-2442SS	100 lbs	WRSAD4-54-2442SS	97 lbs	WRS4-63-2442SS	104 lbs	WRSAD4-63-2442SS	99 lbs	
24" x 48"	WRS4-54-2448SS	108 lbs	WRSAD4-54-2448SS	105 lbs	WRS4-63-2448SS	112 lbs	WRSAD4-63-2448SS	107 lbs	
24" x 54"	WRS4-54-2454SS	124 lbs	WRSAD4-54-2454SS	121 lbs	WRS4-63-2454SS	128 lbs	WRSAD4-63-2454SS	123 lbs	
24" x 60"	WRS4-54-2460SS	136 lbs	WRSAD4-54-2460SS	133 lbs	WRS4-63-2460SS	140 lbs	WRSAD4-63-2460SS	135 lbs	
24" x 72"	WRS4-54-2472SS	148 lbs	WRSAD4-54-2472SS	145 lbs	WRS4-63-2472SS	152 lbs	WRSAD4-63-2472SS	147 lbs	

Shelving units include 4 posts and 4 shelves. Add-On units include 2 posts, 4 shelves and 8 shelf clamps.

304 STAINLESS STEEL

Up to 400-600 lb. LOAD CAPACITY PER SHELF

74" H - STAINLESS SOLID SHELVING 4 SHELVES				86" H - STAINLESS SOLID SHELVING 4 SHELVES					
STARTER KIT			ADD-ON KIT		STARTER KIT			ADD-ON KIT	
SHELF W" x L"	MODEL NO.	SHIP WGT	MODEL NO.	SHIP WGT	MODEL NO.	SHIP WGT	MODEL NO.	SHIP WGT	
14" x 36"	WRS4-74-1436SS	72 lbs	WRSAD4-74-1436SS	67 lbs	WRS4-86-1436SS	76 lbs	WRSAD4-86-1436SS	69 lbs	
14" x 42"	WRS4-74-1442SS	76 lbs	WRSAD4-74-1442SS	71 lbs	WRS4-86-1442SS	80 lbs	WRSAD4-86-1442SS	73 lbs	
14" x 48"	WRS4-74-1448SS	84 lbs	WRSAD4-74-1448SS	79 lbs	WRS4-86-1448SS	88 lbs	WRSAD4-86-1448SS	81 lbs	
14" x 54"	WRS4-74-1454SS	96 lbs	WRSAD4-74-1454SS	91 lbs	WRS4-86-1454SS	100 lbs	WRSAD4-86-1454SS	93 lbs	
14" x 60"	WRS4-74-1460SS	104 lbs	WRSAD4-74-1460SS	99 lbs	WRS4-86-1460SS	108 lbs	WRSAD4-86-1460SS	101 lbs	
14" x 72"	WRS4-74-1472SS	120 lbs	WRSAD4-74-1472SS	115 lbs	WRS4-86-1472SS	124 lbs	WRSAD4-86-1472SS	117 lbs	
18" x 24"	WRS4-74-1824SS	60 lbs	WRSAD4-74-1824SS	55 lbs	WRS4-86-1824SS	64 lbs	WRSAD4-86-1824SS	57 lbs	
18" x 30"	WRS4-74-1830SS	72 lbs	WRSAD4-74-1830SS	67 lbs	WRS4-86-1830SS	76 lbs	WRSAD4-86-1830SS	69 lbs	
18" x 36"	WRS4-74-1836SS	80 lbs	WRSAD4-74-1836SS	75 lbs	WRS4-86-1836SS	84 lbs	WRSAD4-86-1836SS	77 lbs	
18" x 42"	WRS4-74-1842SS	88 lbs	WRSAD4-74-1842SS	83 lbs	WRS4-86-1842SS	92 lbs	WRSAD4-86-1842SS	85 lbs	
18" x 48"	WRS4-74-1848SS	96 lbs	WRSAD4-74-1848SS	91 lbs	WRS4-86-1848SS	100 lbs	WRSAD4-86-1848SS	93 lbs	
18" x 54"	WRS4-74-1854SS	104 lbs	WRSAD4-74-1854SS	99 lbs	WRS4-86-1854SS	108 lbs	WRSAD4-86-1854SS	101 lbs	
18" x 60"	WRS4-74-1860SS	112 lbs	WRSAD4-74-1860SS	107 lbs	WRS4-86-1860SS	116 lbs	WRSAD4-86-1860SS	109 lbs	
18" x 72"	WRS4-74-1872SS	124 lbs	WRSAD4-74-1872SS	119 lbs	WRS4-86-1872SS	128 lbs	WRSAD4-86-1872SS	121 lbs	
21" x 24"	WRS4-74-2124SS	68 lbs	WRSAD4-74-2124SS	63 lbs	WRS4-86-2124SS	72 lbs	WRSAD4-86-2124SS	65 lbs	
21" x 30"	WRS4-74-2130SS	76 lbs	WRSAD4-74-2130SS	71 lbs	WRS4-86-2130SS	80 lbs	WRSAD4-86-2130SS	73 lbs	
21" x 36"	WRS4-74-2136SS	88 lbs	WRSAD4-74-2136SS	83 lbs	WRS4-86-2136SS	92 lbs	WRSAD4-86-2136SS	85 lbs	
21" x 42"	WRS4-74-2142SS	100 lbs	WRSAD4-74-2142SS	95 lbs	WRS4-86-2142SS	104 lbs	WRSAD4-86-2142SS	97 lbs	
21" x 48"	WRS4-74-2148SS	108 lbs	WRSAD4-74-2148SS	103 lbs	WRS4-86-2148SS	112 lbs	WRSAD4-86-2148SS	105 lbs	
21" x 54"	WRS4-74-2154SS	116 lbs	WRSAD4-74-2154SS	111 lbs	WRS4-86-2154SS	120 lbs	WRSAD4-86-2154SS	113 lbs	
21" x 60"	WRS4-74-2160SS	128 lbs	WRSAD4-74-2160SS	123 lbs	WRS4-86-2160SS	132 lbs	WRSAD4-86-2160SS	125 lbs	
21" x 72"	WRS4-74-2172SS	136 lbs	WRSAD4-74-2172SS	131 lbs	WRS4-86-2172SS	140 lbs	WRSAD4-86-2172SS	133 lbs	
24" x 24"	WRS4-74-2424SS	76 lbs	WRSAD4-74-2424SS	71 lbs	WRS4-86-2424SS	80 lbs	WRSAD4-86-2424SS	73 lbs	
24" x 30"	WRS4-74-2430SS	84 lbs	WRSAD4-74-2430SS	79 lbs	WRS4-86-2430SS	88 lbs	WRSAD4-86-2430SS	81 lbs	
24" x 36"	WRS4-74-2436SS	92 lbs	WRSAD4-74-2436SS	87 lbs	WRS4-86-2436SS	96 lbs	WRSAD4-86-2436SS	89 lbs	
24" x 42"	WRS4-74-2442SS	104 lbs	WRSAD4-74-2442SS	99 lbs	WRS4-86-2442SS	108 lbs	WRSAD4-86-2442SS	101 lbs	
24" x 48"	WRS4-74-2448SS	112 lbs	WRSAD4-74-2448SS	107 lbs	WRS4-86-2448SS	116 lbs	WRSAD4-86-2448SS	109 lbs	
24" x 54"	WRS4-74-2454SS	128 lbs	WRSAD4-74-2454SS	123 lbs	WRS4-86-2454SS	132 lbs	WRSAD4-86-2454SS	125 lbs	
24" x 60"	WRS4-74-2460SS	140 lbs	WRSAD4-74-2460SS	135 lbs	WRS4-86-2460SS	144 lbs	WRSAD4-86-2460SS	137 lbs	
24" x 72"	WRS4-74-2472SS	152 lbs	WRSAD4-74-2472SS	147 lbs	WRS4-86-2472SS	156 lbs	WRSAD4-86-2472SS	149 lbs	

Shelving units include 4 posts and 4 shelves. Add-On units include 2 posts, 4 shelves and 8 shelf clamps.



LOWEST PRICE GUARANTEE

54" H - STAINLESS SOLID SHELVING 5 SHELVES				63" H - STAINLESS SOLID SHELVING 5 SHELVES				
STARTER KIT		ADD-ON KIT		STARTER KIT		ADD-ON KIT		
SHELF W" x L"	MODEL NO.	SHIP WGT	MODEL NO.	SHIP WGT	MODEL NO.	SHIP WGT	MODEL NO.	SHIP WGT
14" x 36"	WRS5-54-1436SS	82 lbs	WRSAD5-54-1436SS	79 lbs	WRS5-63-1436SS	86 lbs	WRSAD5-63-1436SS	81 lbs
14" x 42"	WRS5-54-1442SS	87 lbs	WRSAD5-54-1442SS	84 lbs	WRS5-63-1442SS	91 lbs	WRSAD5-63-1442SS	86 lbs
14" x 48"	WRS5-54-1448SS	97 lbs	WRSAD5-54-1448SS	94 lbs	WRS5-63-1448SS	101 lbs	WRSAD5-63-1448SS	96 lbs
14" x 54"	WRS5-54-1454SS	112 lbs	WRSAD5-54-1454SS	109 lbs	WRS5-63-1454SS	116 lbs	WRSAD5-63-1454SS	111 lbs
14" x 60"	WRS5-54-1460SS	122 lbs	WRSAD5-54-1460SS	119 lbs	WRS5-63-1460SS	126 lbs	WRSAD5-63-1460SS	121 lbs
14" x 72"	WRS5-54-1472SS	142 lbs	WRSAD5-54-1472SS	139 lbs	WRS5-63-1472SS	146 lbs	WRSAD5-63-1472SS	141 lbs
18" x 24"	WRS5-54-1824SS	67 lbs	WRSAD5-54-1824SS	64 lbs	WRS5-63-1824SS	71 lbs	WRSAD5-63-1824SS	66 lbs
18" x 30"	WRS5-54-1830SS	82 lbs	WRSAD5-54-1830SS	79 lbs	WRS5-63-1830SS	86 lbs	WRSAD5-63-1830SS	81 lbs
18" x 36"	WRS5-54-1836SS	92 lbs	WRSAD5-54-1836SS	89 lbs	WRS5-63-1836SS	96 lbs	WRSAD5-63-1836SS	91 lbs
18" x 42"	WRS5-54-1842SS	102 lbs	WRSAD5-54-1842SS	99 lbs	WRS5-63-1842SS	106 lbs	WRSAD5-63-1842SS	101 lbs
18" x 48"	WRS5-54-1848SS	112 lbs	WRSAD5-54-1848SS	109 lbs	WRS5-63-1848SS	116 lbs	WRSAD5-63-1848SS	111 lbs
18" x 54"	WRS5-54-1854SS	122 lbs	WRSAD5-54-1854SS	119 lbs	WRS5-63-1854SS	126 lbs	WRSAD5-63-1854SS	121 lbs
18" x 60"	WRS5-54-1860SS	132 lbs	WRSAD5-54-1860SS	129 lbs	WRS5-63-1860SS	136 lbs	WRSAD5-63-1860SS	131 lbs
18" x 72"	WRS5-54-1872SS	147 lbs	WRSAD5-54-1872SS	144 lbs	WRS5-63-1872SS	151 lbs	WRSAD5-63-1872SS	146 lbs
21" x 24"	WRS5-54-2124SS	77 lbs	WRSAD5-54-2124SS	74 lbs	WRS5-63-2124SS	81 lbs	WRSAD5-63-2124SS	76 lbs
21" x 30"	WRS5-54-2130SS	87 lbs	WRSAD5-54-2130SS	84 lbs	WRS5-63-2130SS	91 lbs	WRSAD5-63-2130SS	86 lbs
21" x 36"	WRS5-54-2136SS	102 lbs	WRSAD5-54-2136SS	99 lbs	WRS5-63-2136SS	106 lbs	WRSAD5-63-2136SS	101 lbs
21" x 42"	WRS5-54-2142SS	117 lbs	WRSAD5-54-2142SS	114 lbs	WRS5-63-2142SS	121 lbs	WRSAD5-63-2142SS	116 lbs
21" x 48"	WRS5-54-2148SS	127 lbs	WRSAD5-54-2148SS	124 lbs	WRS5-63-2148SS	131 lbs	WRSAD5-63-2148SS	126 lbs
21" x 54"	WRS5-54-2154SS	137 lbs	WRSAD5-54-2154SS	134 lbs	WRS5-63-2154SS	141 lbs	WRSAD5-63-2154SS	136 lbs
21" x 60"	WRS5-54-2160SS	152 lbs	WRSAD5-54-2160SS	149 lbs	WRS5-63-2160SS	156 lbs	WRSAD5-63-2160SS	151 lbs
21" x 72"	WRS5-54-2172SS	162 lbs	WRSAD5-54-2172SS	159 lbs	WRS5-63-2172SS	166 lbs	WRSAD5-63-2172SS	161 lbs
24" x 24"	WRS5-54-2424SS	87 lbs	WRSAD5-54-2424SS	84 lbs	WRS5-63-2424SS	91 lbs	WRSAD5-63-2424SS	86 lbs
24" x 30"	WRS5-54-2430SS	97 lbs	WRSAD5-54-2430SS	94 lbs	WRS5-63-2430SS	101 lbs	WRSAD5-63-2430SS	96 lbs
24" x 36"	WRS5-54-2436SS	107 lbs	WRSAD5-54-2436SS	104 lbs	WRS5-63-2436SS	111 lbs	WRSAD5-63-2436SS	106 lbs
24" x 42"	WRS5-54-2442SS	122 lbs	WRSAD5-54-2442SS	119 lbs	WRS5-63-2442SS	126 lbs	WRSAD5-63-2442SS	121 lbs
24" x 48"	WRS5-54-2448SS	132 lbs	WRSAD5-54-2448SS	129 lbs	WRS5-63-2448SS	136 lbs	WRSAD5-63-2448SS	131 lbs
24" x 54"	WRS5-54-2454SS	152 lbs	WRSAD5-54-2454SS	149 lbs	WRS5-63-2454SS	156 lbs	WRSAD5-63-2454SS	151 lbs
24" x 60"	WRS5-54-2460SS	167 lbs	WRSAD5-54-2460SS	164 lbs	WRS5-63-2460SS	171 lbs	WRSAD5-63-2460SS	166 lbs
24" x 72"	WRS5-54-2472SS	182 lbs	WRSAD5-54-2472SS	179 lbs	WRS5-63-2472SS	186 lbs	WRSAD5-63-2472SS	181 lbs

Shelving units include 4 posts and 5 shelves. Add-On units include 2 posts, 5 shelves and 10 shelf clamps.

304 STAINLESS STEEL

Up to 400-600 lb. LOAD CAPACITY PER SHELF

74" H - STAINLESS SOLID SHELVING 5 SHELVES				86" H - STAINLESS SOLID SHELVING 5 SHELVES				
STARTER KIT		ADD-ON KIT		STARTER KIT		ADD-ON KIT		
SHELF W" x L"	MODEL NO.	SHIP WGT	MODEL NO.	SHIP WGT	MODEL NO.	SHIP WGT	MODEL NO.	SHIP WGT
14" x 36"	WRS5-74-1436SS	86 lbs	WRSAD5-74-1436SS	81 lbs	WRS5-86-1436SS	90 lbs	WRSAD5-86-1436SS	83 lbs
14" x 42"	WRS5-74-1442SS	91 lbs	WRSAD5-74-1442SS	86 lbs	WRS5-86-1442SS	95 lbs	WRSAD5-86-1442SS	88 lbs
14" x 48"	WRS5-74-1448SS	101 lbs	WRSAD5-74-1448SS	91 lbs	WRS5-86-1448SS	105 lbs	WRSAD5-86-1448SS	98 lbs
14" x 54"	WRS5-74-1454SS	116 lbs	WRSAD5-74-1454SS	111 lbs	WRS5-86-1454SS	120 lbs	WRSAD5-86-1454SS	113 lbs
14" x 60"	WRS5-74-1460SS	126 lbs	WRSAD5-74-1460SS	121 lbs	WRS5-86-1460SS	130 lbs	WRSAD5-86-1460SS	123 lbs
14" x 72"	WRS5-74-1472SS	146 lbs	WRSAD5-74-1472SS	141 lbs	WRS5-86-1472SS	150 lbs	WRSAD5-86-1472SS	143 lbs
18" x 24"	WRS5-74-1824SS	71 lbs	WRSAD5-74-1824SS	66 lbs	WRS5-86-1824SS	75 lbs	WRSAD5-86-1824SS	68 lbs
18" x 30"	WRS5-74-1830SS	86 lbs	WRSAD5-74-1830SS	81 lbs	WRS5-86-1830SS	90 lbs	WRSAD5-86-1830SS	83 lbs
18" x 36"	WRS5-74-1836SS	96 lbs	WRSAD5-74-1836SS	91 lbs	WRS5-86-1836SS	100 lbs	WRSAD5-86-1836SS	93 lbs
18" x 42"	WRS5-74-1842SS	106 lbs	WRSAD5-74-1842SS	101 lbs	WRS5-86-1842SS	110 lbs	WRSAD5-86-1842SS	103 lbs
18" x 48"	WRS5-74-1848SS	116 lbs	WRSAD5-74-1848SS	111 lbs	WRS5-86-1848SS	120 lbs	WRSAD5-86-1848SS	113 lbs
18" x 54"	WRS5-74-1854SS	126 lbs	WRSAD5-74-1854SS	121 lbs	WRS5-86-1854SS	130 lbs	WRSAD5-86-1854SS	123 lbs
18" x 60"	WRS5-74-1860SS	136 lbs	WRSAD5-74-1860SS	131 lbs	WRS5-86-1860SS	140 lbs	WRSAD5-86-1860SS	133 lbs
18" x 72"	WRS5-74-1872SS	151 lbs	WRSAD5-74-1872SS	151 lbs	WRS5-86-1872SS	155 lbs	WRSAD5-86-1872SS	153 lbs
21" x 24"	WRS5-74-2124SS	81 lbs	WRSAD5-74-2124SS	76 lbs	WRS5-86-2124SS	85 lbs	WRSAD5-86-2124SS	78 lbs
21" x 30"	WRS5-74-2130SS	91 lbs	WRSAD5-74-2130SS	86 lbs	WRS5-86-2130SS	95 lbs	WRSAD5-86-2130SS	88 lbs
21" x 36"	WRS5-74-2136SS	106 lbs	WRSAD5-74-2136SS	101 lbs	WRS5-86-2136SS	110 lbs	WRSAD5-86-2136SS	103 lbs
21" x 42"	WRS5-74-2142SS	121 lbs	WRSAD5-74-2142SS	116 lbs	WRS5-86-2142SS	125 lbs	WRSAD5-86-2142SS	118 lbs
21" x 48"	WRS5-74-2148SS	131 lbs	WRSAD5-74-2148SS	121 lbs	WRS5-86-2148SS	135 lbs	WRSAD5-86-2148SS	123 lbs
21" x 54"	WRS5-74-2154SS	141 lbs	WRSAD5-74-2154SS	136 lbs	WRS5-86-2154SS	145 lbs	WRSAD5-86-2154SS	138 lbs
21" x 60"	WRS5-74-2160SS	156 lbs	WRSAD5-74-2160SS	151 lbs	WRS5-86-2160SS	160 lbs	WRSAD5-86-2160SS	153 lbs
21" x 72"	WRS5-74-2172SS	166 lbs	WRSAD5-74-2172SS	166 lbs	WRS5-86-2172SS	170 lbs	WRSAD5-86-2172SS	166 lbs
24" x 24"	WRS5-74-2424SS	91 lbs	WRSAD5-74-2424SS	86 lbs	WRS5-86-2424SS	95 lbs	WRSAD5-86-2424SS	88 lbs
24" x 30"	WRS5-74-2430SS	101 lbs	WRSAD5-74-2430SS	96 lbs	WRS5-86-2430SS	105 lbs	WRSAD5-86-2430SS	98 lbs
24" x 36"	WRS5-74-2436SS	111 lbs	WRSAD5-74-2436SS	106 lbs	WRS5-86-2436SS	115 lbs	WRSAD5-86-2436SS	108 lbs
24" x 42"	WRS5-74-2442SS	126 lbs	WRSAD5-74-2442SS	121 lbs	WRS5-86-2442SS	130 lbs	WRSAD5-86-2442SS	123 lbs
24" x 48"	WRS5-74-2448SS	136 lbs	WRSAD5-74-2448SS	131 lbs	WRS5-86-2448SS	140 lbs	WRSAD5-86-2448SS	133 lbs
24" x 54"	WRS5-74-2454SS	156 lbs	WRSAD5-74-2454SS	151 lbs	WRS5-86-2454SS	160 lbs	WRSAD5-86-2454SS	153 lbs
24" x 60"	WRS5-74-2460SS	171 lbs	WRSAD5-74-2460SS	166 lbs	WRS5-86-2460SS	175 lbs	WRSAD5-86-2460SS	168 lbs
24" x 72"	WRS5-74-2472SS	186 lbs	WRSAD5-74-2472SS	181 lbs	WRS5-86-2472SS	205 lbs	WRSAD5-86-2472SS	198 lbs

Shelving units include 4 posts and 5 shelves. Add-On units include 2 posts, 5 shelves and 10 shelf clamps.

5 Shelf Starter Kits

Solid flat shelves allows for storage from small to large items, and the marine edge perimeter prevents spillage. The double hemmed 18 gauge 304 stainless steel gives the solid shelf excellent strength characteristics. All solid shelf units consist of 5 shelves and 4 posts. Mobilize starter kit shelving unit using optional mobile kit WR-00HS, see pg. 167. Finish: Stainless Steel



MOBILIZE YOUR SHELVING

DB - Donut Bumper Non-marking donut bumper used to protect walls and help cushion impact. WR-00HS (Mobile Kit)\* Set of four swivel 5" x 1-1/4" thermoplastic resin stainless steel casters with zerk grease fittings, 2 with brake. Can be used with all units shown. Up to 1,200 lb. load capacity. \*Mobile kits recommended only for shelves 18" and deeper.



QSMC Shelf Clamp Shelf Clamp eliminates 2 posts per shelving section. Two QSMC clamps are required per shelf. Finish: Aluminum (Sold individually)



5 SHELF ADD-ON KIT

5 Shelf Add-On Kits

Additional Add-On kits allow you to expand your Starter kit by sharing a set of posts. Configuration options include side to side, back to back and right angles (L-Shape). Add-on units consist of 5 shelves, 2 posts and 10 shelf clamps. Additional shelves and posts may be purchased separately, see chart on pg. 111. Units with Add-On kit cannot be made mobile. Finish: Stainless Steel

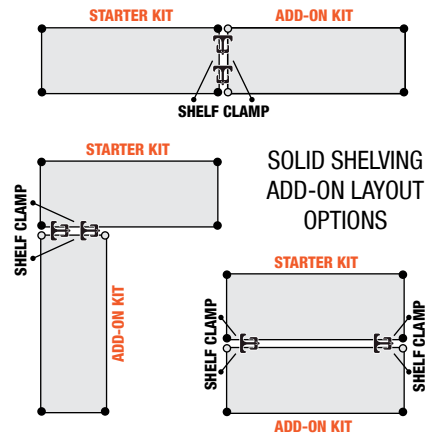

Polymer Wire Shelves



**NEW**

Hybrid wire epoxy and polymer mat shelves offer a unique combination of shelf sizes. The shelf construction is supported with architectural wire trusses to provide from up to 600 lb. to 800 lb. capacity per shelf. Vented shelf plates allows air to circulate for minimal dirt accumulation and light to penetrate for increased product visibility. Shelf plates are easily removable and dishwasher safe. Antimicrobial durable finish and aesthetically pleasing. National Sanitation Foundation (NSF) Approved. Plastic split sleeves are included with each shelf and replacements are available. S-Hooks are available for continuous runs of shelving. Two hooks should be placed per shelf where two posts are not utilized. No tools required for assembly.

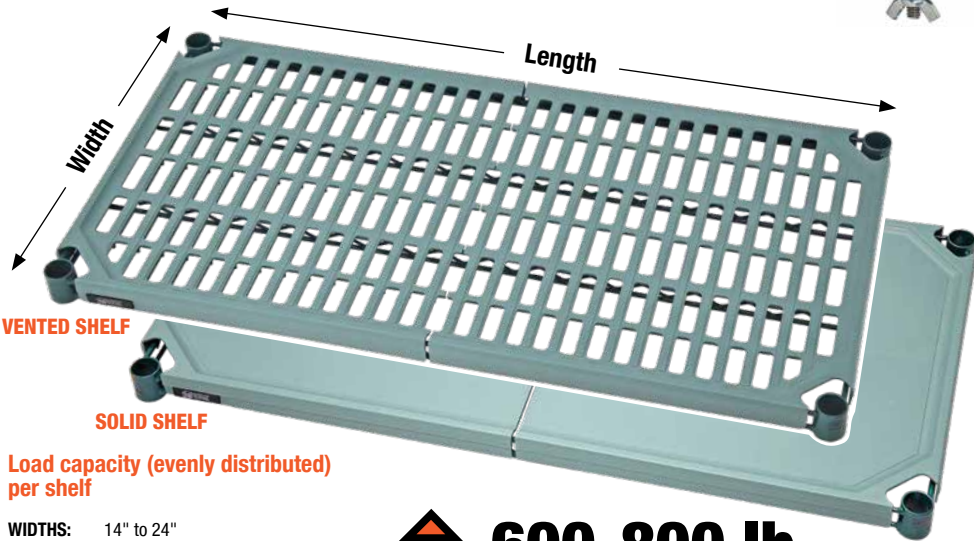

Load capacity (evenly distributed) per shelf

WIDTHS: 14" to 24"  
LENGTHS: Up to 800 lbs. for 24" to 48"  
Up to 600 lbs. for 54" or longer

**Up to 600-800 lb.**  
**LOAD CAPACITY PER SHELF**

**WR-SS Split Sleeves**  
Additional pieces available  
(Sold as 4-pairs)



**S-HOOKWPM S-Hook**  
Additional pieces available  
(Sold as 4-pairs)



VENTED MODEL NO.	SOLID MODEL NO.	SHELF W" x L"	SHIP WGT
<b>14" Width - Shelves</b>			
1424WPM	1424WPMS	14" x 24"	4 lbs
1430WPM	1430WPMS	14" x 30"	6 lbs
1436WPM	1436WPMS	14" x 36"	8 lbs
1442WPM	1442WPMS	14" x 42"	10 lbs
1448WPM	1448WPMS	14" x 48"	12 lbs
1454WPM	1454WPMS	14" x 54"	13 lbs
1460WPM	1460WPMS	14" x 60"	15 lbs
1472WPM	1472WPMS	14" x 72"	18 lbs
<b>18" Width - Shelves</b>			
1824WPM	1824WPMS	18" x 24"	5 lbs
1830WPM	1830WPMS	18" x 30"	7 lbs
1836WPM	1836WPMS	18" x 36"	9 lbs
1842WPM	1842WPMS	18" x 42"	10 lbs
1848WPM	1848WPMS	18" x 48"	11 lbs
1854WPM	1854WPMS	18" x 54"	12 lbs
1860WPM	1860WPMS	18" x 60"	13 lbs
1872WPM	1872WPMS	18" x 72"	16 lbs
<b>21" Width - Shelves</b>			
2124WPM	2124WPMS	21" x 24"	5 lbs
2130WPM	2130WPMS	21" x 30"	7 lbs
2136WPM	2136WPMS	21" x 36"	9 lbs
2142WPM	2142WPMS	21" x 42"	10 lbs
2148WPM	2148WPMS	21" x 48"	11 lbs
2154WPM	2154WPMS	21" x 54"	12 lbs
2160WPM	2160WPMS	21" x 60"	13 lbs
2172WPM	2172WPMS	21" x 72"	16 lbs
<b>24" Width - Shelves</b>			
2424WPM	2424WPMS	24" x 24"	9 lbs
2430WPM	2430WPMS	24" x 30"	11 lbs
2436WPM	2436WPMS	24" x 36"	13 lbs
2442WPM	2442WPMS	24" x 42"	14 lbs
2448WPM	2448WPMS	24" x 48"	15 lbs
2454WPM	2454WPMS	24" x 54"	16 lbs
2460WPM	2460WPMS	24" x 60"	19 lbs
2472WPM	2472WPMS	24" x 72"	23 lbs

Polymer Wire Posts



All posts are fabricated from 16 gauge carbon steel with location grooves on one inch increments and ease for shelf installation. Numbers are printed between grooves for quick assembly. Posts are double grooved in consistent intervals for quick identification. Leveling legs are enclosed with all posts. Leveling legs cannot be used in conjunction with stem casters. Custom post heights are available, call for additional information.

MODEL NO.	DESCRIPTION	SHIP WGT
P6P	6"H Post	1 lb
P14P	14"H Post	2 lbs
P34P	34"H Post	2 lbs
P54P	54"H Post	3 lbs
P63P*	63"H Post	4 lbs
P74P*	74"H Post	4 lbs
P86P*	86"H Post	5 lbs
P96P	96"H Post	6 lbs

\*PRE-INSERTED LEVELERS For easy installation, 63", 74" and 86" posts are available with pre-inserted leveler and bolt by adding an X to the Model No. P74PX

**CUSTOM POST HEIGHTS ALSO AVAILABLE**

**LASER PRINTED NUMBERS**  
For quick shelf positioning

**DOUBLE GROOVES**  
For quick identification

**W-PLI Post Insert**  
Additional pieces available  
(Sold as 4-pack)

**W-PLB Post Leveler** adjusts up or down allowing height flexibility  
(Sold as 4-pack)

**FP Foot Plate**  
**FG Floor Guides**  
(Sold separately as 4-pack)

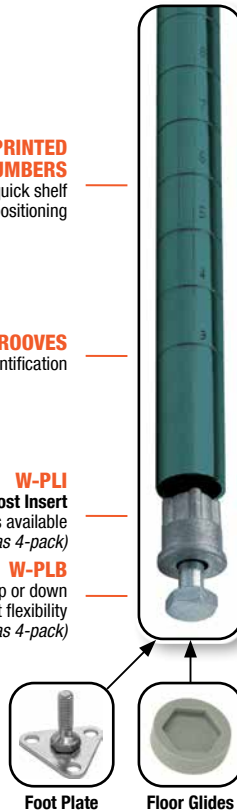

**W-PC-STUD Threaded Stud Connector** can be utilized to connect two posts enabling any post height to be achieved. Must be used with **WR-WMB** to secure to wall  
See pg. 166

**W-PC Replacement Post Cap**  
(Sold as 4-pack)



**4 Shelf Polymer Wire Shelving Unit**

**Up to 600-800 lb.**  
LOAD CAPACITY PER SHELF

ADD SUFFIX "S" TO MODEL NO. TO ORDER SOLID SHELF UNIT

Ex. WR63-1424WPM**S** or WR63-1424WPM**S-5**

MODEL NO.	DIMENSIONS W" x L" x H"	SHIP WGT	MODEL NO.	DIMENSIONS W" x L" x H"	SHIP WGT	MODEL NO.	DIMENSIONS W" x L" x H"	SHIP WGT
<b>63"H - 4 Shelves Units</b>			<b>74"H - 4 Shelves Units</b>			<b>86"H - 4 Shelves Units</b>		
WR63-1424WPM	14" x 24" x 63"	32 lbs	WR74-1424WPM	14" x 24" x 74"	32 lbs	WR86-1424WPM	14" x 24" x 86"	36 lbs
WR63-1430WPM	14" x 30" x 63"	41 lbs	WR74-1430WPM	14" x 30" x 74"	41 lbs	WR86-1430WPM	14" x 30" x 86"	45 lbs
WR63-1436WPM	14" x 36" x 63"	48 lbs	WR74-1436WPM	14" x 36" x 74"	48 lbs	WR86-1436WPM	14" x 36" x 86"	52 lbs
WR63-1442WPM	14" x 42" x 63"	56 lbs	WR74-1442WPM	14" x 42" x 74"	56 lbs	WR86-1442WPM	14" x 42" x 86"	60 lbs
WR63-1448WPM	14" x 48" x 63"	64 lbs	WR74-1448WPM	14" x 48" x 74"	64 lbs	WR86-1448WPM	14" x 48" x 86"	68 lbs
WR63-1454WPM	14" x 54" x 63"	70 lbs	WR74-1454WPM	14" x 54" x 74"	70 lbs	WR86-1454WPM	14" x 54" x 86"	74 lbs
WR63-1460WPM	14" x 60" x 63"	76 lbs	WR74-1460WPM	14" x 60" x 74"	76 lbs	WR86-1460WPM	14" x 60" x 86"	80 lbs
WR63-1472WPM	14" x 72" x 63"	89 lbs	WR74-1472WPM	14" x 72" x 74"	89 lbs	WR86-1472WPM	14" x 72" x 86"	93 lbs
WR63-1824WPM	18" x 24" x 63"	36 lbs	WR74-1824WPM	18" x 24" x 74"	36 lbs	WR86-1824WPM	18" x 24" x 86"	40 lbs
WR63-1830WPM	18" x 30" x 63"	48 lbs	WR74-1830WPM*	18" x 30" x 74"	48 lbs	WR86-1830WPM	18" x 30" x 86"	52 lbs
WR63-1836WPM	18" x 36" x 63"	56 lbs	WR74-1836WPM*	18" x 36" x 74"	56 lbs	WR86-1836WPM	18" x 36" x 86"	60 lbs
WR63-1842WPM	18" x 42" x 63"	64 lbs	WR74-1842WPM*	18" x 42" x 74"	64 lbs	WR86-1842WPM	18" x 42" x 86"	68 lbs
WR63-1848WPM	18" x 48" x 63"	68 lbs	WR74-1848WPM*	18" x 48" x 74"	68 lbs	WR86-1848WPM	18" x 48" x 86"	72 lbs
WR63-1854WPM	18" x 54" x 63"	76 lbs	WR74-1854WPM	18" x 54" x 74"	76 lbs	WR86-1854WPM	18" x 54" x 86"	80 lbs
WR63-1860WPM	18" x 60" x 63"	84 lbs	WR74-1860WPM	18" x 60" x 74"	84 lbs	WR86-1860WPM	18" x 60" x 86"	88 lbs
WR63-1872WPM	18" x 72" x 63"	96 lbs	WR74-1872WPM	18" x 72" x 74"	96 lbs	WR86-1872WPM	18" x 72" x 86"	100 lbs
WR63-2124WPM	21" x 24" x 63"	36 lbs	WR74-2124WPM	21" x 24" x 74"	36 lbs	WR86-2124WPM	21" x 24" x 86"	40 lbs
WR63-2130WPM	21" x 30" x 63"	56 lbs	WR74-2130WPM*	21" x 30" x 74"	56 lbs	WR86-2130WPM	21" x 30" x 86"	60 lbs
WR63-2136WPM	21" x 36" x 63"	64 lbs	WR74-2136WPM*	21" x 36" x 74"	64 lbs	WR86-2136WPM	21" x 36" x 86"	68 lbs
WR63-2142WPM	21" x 42" x 63"	68 lbs	WR74-2142WPM*	21" x 42" x 74"	68 lbs	WR86-2142WPM	21" x 42" x 86"	72 lbs
WR63-2148WPM	21" x 48" x 63"	76 lbs	WR74-2148WPM*	21" x 48" x 74"	76 lbs	WR86-2148WPM	21" x 48" x 86"	80 lbs
WR63-2154WPM	21" x 54" x 63"	84 lbs	WR74-2154WPM	21" x 54" x 74"	84 lbs	WR86-2154WPM	21" x 54" x 86"	88 lbs
WR63-2160WPM	21" x 60" x 63"	92 lbs	WR74-2160WPM	21" x 60" x 74"	92 lbs	WR86-2160WPM	21" x 60" x 86"	96 lbs
WR63-2172WPM	21" x 72" x 63"	104 lbs	WR74-2172WPM	21" x 72" x 74"	104 lbs	WR86-2172WPM	21" x 72" x 86"	108 lbs
WR63-2424WPM	24" x 24" x 63"	52 lbs	WR74-2424WPM	24" x 24" x 74"	52 lbs	WR86-2424WPM	24" x 24" x 86"	56 lbs
WR63-2430WPM	24" x 30" x 63"	64 lbs	WR74-2430WPM*	24" x 30" x 74"	64 lbs	WR86-2430WPM	24" x 30" x 86"	68 lbs
WR63-2436WPM	24" x 36" x 63"	68 lbs	WR74-2436WPM*	24" x 36" x 74"	68 lbs	WR86-2436WPM	24" x 36" x 86"	72 lbs
WR63-2442WPM	24" x 42" x 63"	72 lbs	WR74-2442WPM*	24" x 42" x 74"	72 lbs	WR86-2442WPM	24" x 42" x 86"	76 lbs
WR63-2448WPM	24" x 48" x 63"	80 lbs	WR74-2448WPM*	24" x 48" x 74"	80 lbs	WR86-2448WPM	24" x 48" x 86"	84 lbs
WR63-2454WPM	24" x 54" x 63"	92 lbs	WR74-2454WPM	24" x 54" x 74"	92 lbs	WR86-2454WPM	24" x 54" x 86"	96 lbs
WR63-2460WPM	24" x 60" x 63"	96 lbs	WR74-2460WPM	24" x 60" x 74"	96 lbs	WR86-2460WPM	24" x 60" x 86"	100 lbs
WR63-2472WPM	24" x 72" x 63"	112 lbs	WR74-2472WPM	24" x 72" x 74"	112 lbs	WR86-2472WPM	24" x 72" x 86"	116 lbs

\*PACKAGED AS SINGLE BOX SHELVING UNITS

**5 Shelf Polymer Wire Shelving Unit**

**PRE-INSERTED LEVELERS** For easy installation, 63", 74" and 86" posts are available with pre-inserted leveler and bolt by adding an X to the Model No. WR86-2436WPMX, WR86-2436WPM-5X.

**5 SHELF UNIT**  
Proform Green Polymer Finish

MODEL NO.	DIMENSIONS W" x L" x H"	SHIP WGT	MODEL NO.	DIMENSIONS W" x L" x H"	SHIP WGT
<b>74"H - 5 Shelves Units</b>			<b>86"H - 5 Shelves Units</b>		
WR74-1424WPM-5	14" x 24" x 74"	36 lbs	WR86-1424WPM-5	14" x 24" x 86"	40 lbs
WR74-1430WPM-5	14" x 30" x 74"	48 lbs	WR86-1430WPM-5	14" x 30" x 86"	52 lbs
WR74-1436WPM-5	14" x 36" x 74"	56 lbs	WR86-1436WPM-5	14" x 36" x 86"	60 lbs
WR74-1442WPM-5	14" x 42" x 74"	66 lbs	WR86-1442WPM-5	14" x 42" x 86"	70 lbs
WR74-1448WPM-5	14" x 48" x 74"	76 lbs	WR86-1448WPM-5	14" x 48" x 86"	80 lbs
WR74-1454WPM-5	14" x 54" x 74"	83 lbs	WR86-1454WPM-5	14" x 54" x 86"	87 lbs
WR74-1460WPM-5	14" x 60" x 74"	91 lbs	WR86-1460WPM-5	14" x 60" x 86"	95 lbs
WR74-1472WPM-5	14" x 72" x 74"	108 lbs	WR86-1472WPM-5	14" x 72" x 86"	112 lbs
WR74-1824WPM-5	18" x 24" x 74"	41 lbs	WR86-1824WPM-5	18" x 24" x 86"	45 lbs
WR74-1830WPM-5	18" x 30" x 74"	56 lbs	WR86-1830WPM-5	18" x 30" x 86"	60 lbs
WR74-1836WPM-5	18" x 36" x 74"	66 lbs	WR86-1836WPM-5	18" x 36" x 86"	70 lbs
WR74-1842WPM-5	18" x 42" x 74"	76 lbs	WR86-1842WPM-5	18" x 42" x 86"	80 lbs
WR74-1848WPM-5	18" x 48" x 74"	81 lbs	WR86-1848WPM-5	18" x 48" x 86"	85 lbs
WR74-1854WPM-5	18" x 54" x 74"	91 lbs	WR86-1854WPM-5	18" x 54" x 86"	95 lbs
WR74-1860WPM-5	18" x 60" x 74"	101 lbs	WR86-1860WPM-5	18" x 60" x 86"	105 lbs
WR74-1872WPM-5	18" x 72" x 74"	116 lbs	WR86-1872WPM-5	18" x 72" x 86"	120 lbs
WR74-2124WPM-5	21" x 24" x 74"	41 lbs	WR86-2124WPM-5	21" x 24" x 86"	45 lbs
WR74-2130WPM-5	21" x 30" x 74"	66 lbs	WR86-2130WPM-5	21" x 30" x 86"	70 lbs
WR74-2136WPM-5	21" x 36" x 74"	76 lbs	WR86-2136WPM-5	21" x 36" x 86"	80 lbs
WR74-2142WPM-5	21" x 42" x 74"	81 lbs	WR86-2142WPM-5	21" x 42" x 86"	85 lbs
WR74-2148WPM-5	21" x 48" x 74"	91 lbs	WR86-2148WPM-5	21" x 48" x 86"	95 lbs
WR74-2154WPM-5	21" x 54" x 74"	101 lbs	WR86-2154WPM-5	21" x 54" x 86"	105 lbs
WR74-2160WPM-5	21" x 60" x 74"	111 lbs	WR86-2160WPM-5	21" x 60" x 86"	115 lbs
WR74-2172WPM-5	21" x 72" x 74"	126 lbs	WR86-2172WPM-5	21" x 72" x 86"	130 lbs
WR74-2424WPM-5	24" x 24" x 74"	61 lbs	WR86-2424WPM-5	24" x 24" x 86"	65 lbs
WR74-2430WPM-5	24" x 30" x 74"	76 lbs	WR86-2430WPM-5	24" x 30" x 86"	80 lbs
WR74-2436WPM-5	24" x 36" x 74"	81 lbs	WR86-2436WPM-5	24" x 36" x 86"	85 lbs
WR74-2442WPM-5	24" x 42" x 74"	86 lbs	WR86-2442WPM-5	24" x 42" x 86"	90 lbs
WR74-2448WPM-5	24" x 48" x 74"	96 lbs	WR86-2448WPM-5	24" x 48" x 86"	100 lbs
WR74-2454WPM-5	24" x 54" x 74"	111 lbs	WR86-2454WPM-5	24" x 54" x 86"	115 lbs
WR74-2460WPM-5	24" x 60" x 74"	116 lbs	WR86-2460WPM-5	24" x 60" x 86"	120 lbs
WR74-2472WPM-5	24" x 72" x 74"	136 lbs	WR86-2472WPM-5	24" x 72" x 86"	140 lbs



**NOW 3 FINISHES AVAILABLE** ▶ **EXPANDED 1 BOX WIRE SHELVING OFFERING**  
 NOW also available in **BLACK** and **GREEN Epoxy**



**CONVENIENT 1 BOX WIRE SHELVING UNIT**  
 Chrome Finish



**NEW FINISH**  
**CONVENIENT 1 BOX WIRE SHELVING UNIT**  
 Black Epoxy Finish



**NEW FINISH**  
**CONVENIENT 1 BOX WIRE SHELVING UNIT**  
 Green Epoxy Finish

**Convenient 1 Box Wire Shelving Units**

Super competitive cost. All packed in 1 box for super easy inventory control, shipping, and receiving. Four shelf configuration.

**FINISHES:** ◀ CHROME ▶ GREEN EPOXY ▶ BLACK EPOXY

Add SUFFIX to Model No. ▶ Ex. **RWR72-1830LDP**  
 to order Epoxy Finish ▶ **RWR72-1830LDBK**

MODEL NO.	DIMENSIONS W" x L" x H"	SHIP WGT
<b>Chrome One Box Shelving</b>		
RWR72-1830LD	18" x 30" x 72"	35 lbs
RWR72-1836LD	18" x 36" x 72"	38 lbs
RWR72-1842LD	18" x 42" x 72"	42 lbs
RWR72-1848LD	18" x 48" x 72"	46 lbs
RWR72-2430LD	24" x 30" x 72"	40 lbs
RWR72-2436LD	24" x 36" x 72"	46 lbs
RWR72-2442LD	24" x 42" x 72"	51 lbs
RWR72-2448LD	24" x 48" x 72"	56 lbs



**Up to 300 lb.**  
**LOAD CAPACITY PER SHELF**

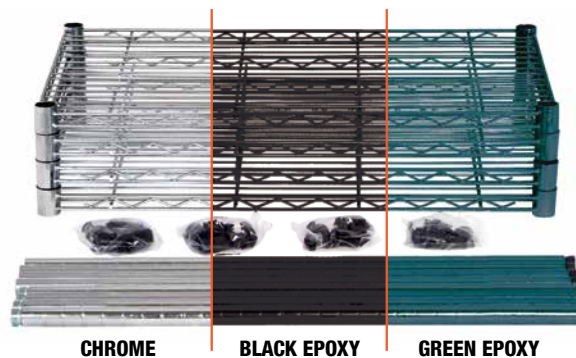

**PERFORMANCE FEATURES:**



- Up to 300 lb. load capacity per shelf (evenly distributed)
- Assembles in minutes
- Wire design allows for air circulation and minimal dust buildup
- Shelves easily adjust on 1" centers to your exact needs
- Ideal storage solution for any commercial, office, warehouse or home application
- Includes posts, shelves, and all needed hardware - all in one box
- No tools required

**SUPER LOW PRICE!**

▶ **SINGLE BOX SHIPMENT**

▶ **SUPER LOW TRANSIT COST**



**MOBILIZE YOUR SHELVING**

**W-PLI - Post Insert**  
 Each unit will require one 4-pack.

**WR-3 (Mobile Kit)**  
 Set of four 3" polyurethane casters, all with brakes. Can be used with all units shown. Up to 800 lb. load capacity.



**1 Box Polymer Wire Shelving Units**

4 shelf configuration. Super competitive cost. All packed in 1 box for super easy inventory control, shipping, and receiving. **Finish:** Proform Green Epoxy

MODEL NO.	DIMENSIONS W" x L" x H"	SHIP WGT
<b>Proform Green Epoxy One Box Shelving</b>		
WR74-1830WPM	18" x 30" x 74"	48 lbs
WR74-1836WPM	18" x 36" x 74"	56 lbs
WR74-1842WPM	18" x 42" x 74"	64 lbs
WR74-1848WPM	18" x 48" x 74"	68 lbs
WR74-2130WPM	21" x 30" x 74"	56 lbs
WR74-2136WPM	21" x 36" x 74"	64 lbs
WR74-2142WPM	21" x 42" x 74"	68 lbs
WR74-2148WPM	21" x 48" x 74"	76 lbs
WR74-2430WPM	24" x 30" x 74"	64 lbs
WR74-2436WPM	24" x 36" x 74"	68 lbs
WR74-2442WPM	24" x 42" x 74"	72 lbs
WR74-2448WPM	24" x 48" x 74"	80 lbs



**MOBILIZE YOUR WIRE SHELVING**

**DB - Donut Bumper**  
Non-marking donut bumper used to protect walls and help cushion impact.

**WR-00H (Mobile Kit)**  
Set of four swivel thermoplastic resin 5" x 1-1/4" casters, two with brakes. Can be used with all units shown. Up to 1,200 lb. load capacity.

For additional Caster options See pg. 167



**4 SHELF UNIT**  
Proform Green Epoxy Finish

**PERFORMANCE FEATURES:**

- 15 year limited warranty on Epoxy, Lifetime limited warranty on plastic
- Up to 600-800 lb. load capacity per shelf
- Smooth, vented, open grid surface allows for air circulation and minimal dust buildup
- Shelf plates are easily removable and dishwasher safe
- NSF Approved
- Antimicrobial
- Resistant against corrosion



- ▶ **SUPER LOW PRICE**
- ▶ **SUPER LOW TRANSIT COST**
- ▶ **SINGLE BOX SHIPMENT**

- INSIDE EACH SINGLE BOX UNIT**
- 4 - posts (2 or 3 pieces each)
  - 4 - wire frames
  - 4 - plastic wire mats (2 or 3 pieces each)
  - 4 - packs of split sleeves

**Up to 600-800 lb. LOAD CAPACITY PER SHELF**



Corner Wire Shelving



When in need of more storage space, Quantum Corner Wire Shelving is the answer. It's great for any corner area. It is versatile and durable, it is easy to assemble. Each shelf holds up to 700 lbs., evenly distributed. This versatile storage option will help your rooms stay neat, organized and maximized.  
**Finishes:** Chrome and Proform Green Epoxy

**REPLACE SUFFIX "C" AT THE END OF MODEL NO. WITH "P" TO ORDER GREEN EPOXY FINISH** Ex. 1836CRNC **P**  
 WR74-1836CRNC **P**  
 WR74-1836CRNC **P**-5

MODEL NO.	SHELF DIMENSIONS A" x B" x C" x D" x E"	SHIP WGT
<b>Corner Wire Shelves</b>		
1836CRNC	37-7/8" x 50-1/4" x 36" x 18" x 27"	16 lbs
2442CRNC	46" x 58-1/2" x 41-3/4" x 24" x 26-1/2"	21 lbs
<b>74"H - Corner Wire Shelving 4 Shelf System</b>		
WR74-1836CRNC	37-7/8" x 50-1/4" x 36" x 18" x 27"	80 lbs
WR74-2442CRNC	46" x 58-1/2" x 41-3/4" x 24" x 26-1/2"	100 lbs
<b>74"H - Corner Wire Shelving 5 Shelf System</b>		
WR74-1836CRNC-5	37-7/8" x 50-1/4" x 36" x 18" x 27"	96 lbs
WR74-2442CRNC-5	46" x 58-1/2" x 41-3/4" x 24" x 26-1/2"	121 lbs

MOBILIZE YOUR SHELVING

**DB - Donut Bumper**  
 Non-marking donut bumper used to protect walls and help cushion impact.



**WR-00H-5 (Mobile Kit)**  
 Set of five swivel thermoplastic resin 5" x 1-1/4" casters, two with brakes. Can be used with all units shown. Up to 1,500 lb. load capacity.



4 SHELF UNIT  
 Proform Green Epoxy Finish

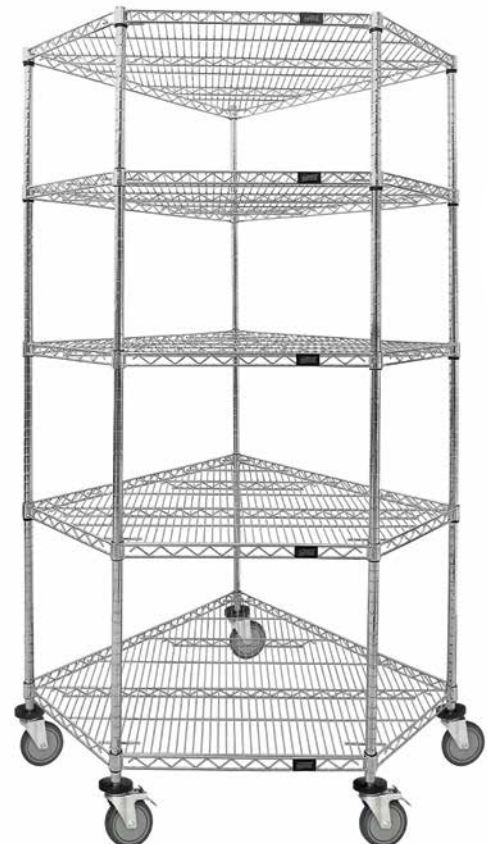

5 SHELF MOBILE UNIT

**NEW FINISH**



1836CRNP  
 Corner Wire Shelf Proform Green Epoxy Finish  
 (Use with 18" deep wire shelving)

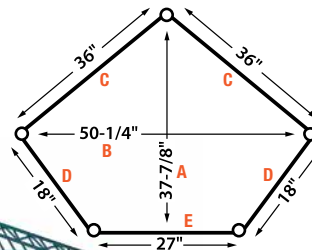

**Up to 700 lb. LOAD CAPACITY PER SHELF**



2442CRNC  
 Corner Wire Shelf Chrome Finish  
 (Use with 24" deep wire shelving)

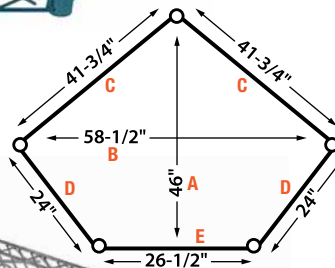

PERFORMANCE FEATURES:

- Up to 700 lb. load capacity per shelf
- Easy assembly with no tools needed
- Compatible with 18" and 24" deep wire shelving add-on units
- Shelves easily adjust on 1" centers to your exact needs
- Ideal storage solution for any commercial, office, warehouse or home application
- Bright chrome or green epoxy finish

CORNER WIRE SHELVING & ADD-ON LAYOUT OPTIONS

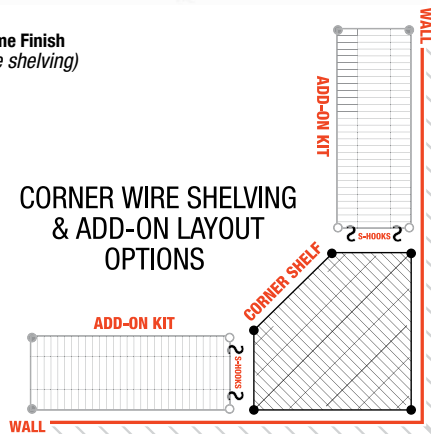

**Reel Shelving Units**



Quantum Reel Shelving offers a safe and efficient method of transporting and storing standard size component reels. New reel shelves are chrome plated and can be used in conjunction with same size standard flat wire shelves. Units are available with conductive accessories providing a static safe storage system to address reel handling and providing stationary or mobile complete storage systems for PCB manufacturers. **Finish:** Chrome

MODEL NO.	DIMENSIONS W" x L"	HANDLES REEL SIZE	REEL CAPACITY	SHIP WGT
<b>1836R16C</b>	18" x 36"	13"-15"	15	10 lbs
<b>1836R40C</b>	18" x 36"	7"	78	12 lbs

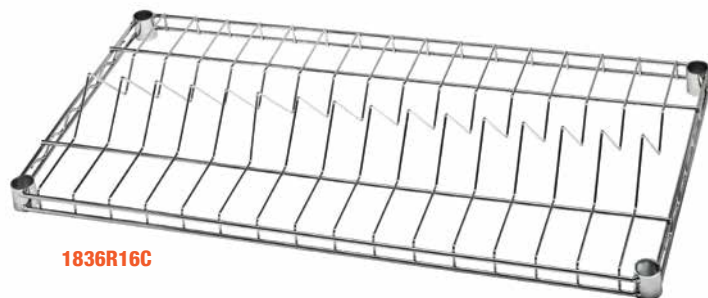

**1836R16C**

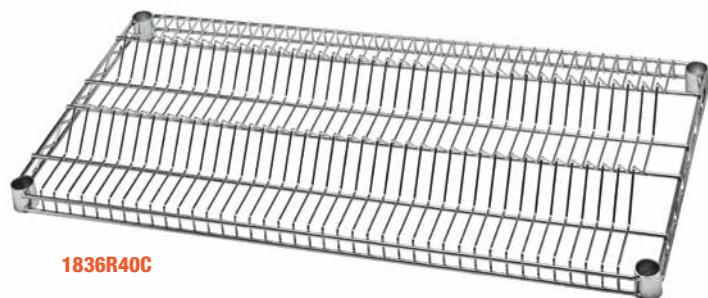

**1836R40C**



**WRC-R264C**  
Chrome Finish

**Up to 400 lb.**  
**LOAD CAPACITY PER SHELF**



MODEL NO.	DIMENSIONS W" x L" x H"	NO. OF SHELVES	SHIP WGT
<b>WRC-R60C</b>	18" x 36" x 69"	(4) 15-Reel Wire Shelves	75 lbs
<b>WRC-R264C</b>	18" x 36" x 69"	(2) 15-Reel Wire Shelves - (3) 78-Reel Wire Shelves	81 lbs
<b>WRC-R468C</b>	18" x 36" x 69"	(6) 78-Reel Wire Shelves	87 lbs

**CARTS ARE CONDUCTIVE/ESD SAFE AND INCLUDES CONDUCTIVE CASTERS, CONDUCTIVE PLASTIC SPLIT SLEEVES, AND DRAG CHAIN**

**Conductive Accessories**

**WR-00CO**  
Conductive Casters  
4 swivel  
- 2 brakes  
- 2 non-brakes



**WR-SSCO**  
Conductive Plastic Split Sleeves



**ESD-DC**  
Drag Chain



## SUPER EASY WAIST HIGH PUSH HANDLES

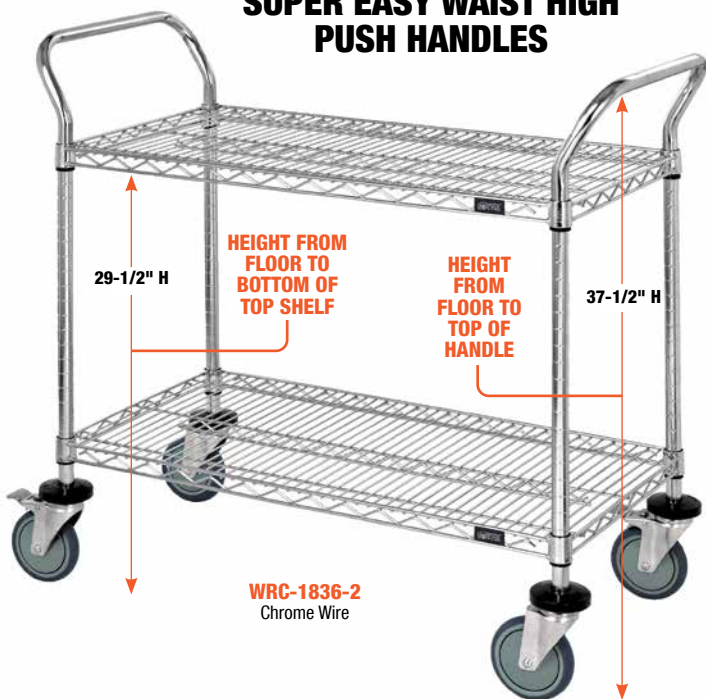

**WRC-1836-2**  
Chrome Wire

## Cylinder Transport/ Inhalation Therapy Cart

Mobile unit can transport up to 12 of the D and/or E cylinders. Protective vinyl coated wires separate and protect cylinders. Unit consists of two u-handles, 4 donut bumpers, 4 conductive swivel casters (2 with brakes), 1 wire shelf and 2 frames with coated wire grid shelf.

**Wire Finish:** Chrome

MODEL NO.	SHIP WGT
Mobile Cylinder Cart 18"W x 24"L x 37-1/2"H	
WRC-IT1824	45 lbs



**WRC-IT1824**  
(Cylinders not included)

## UTILITY CARTS IN ANY STYLE, FINISH, OR CONFIGURATION



Black Epoxy Wire



Solid Stainless Steel

### Wire Utility Carts

Up to **1,200 lb.**  
**MOBILE LOAD CAPACITY**

Give versatility to any operation: food service, hospitals and maintenance. Carts consists of 2 u-handles, 4 donut bumpers, 4 swivel casters (2 with brakes) and wire or solid shelf combinations. **Finishes:** Chrome, Stainless Steel, Green, Gray and Black Epoxy

DIMENSIONS W" x L" x H"	WIRE SHELF					SHIP WGT	WIRE & SOLID SHELF			SOLID SHELF							
	CHROME MODEL NO.	STAINLESS MODEL NO.	PROFORM GREEN EPOXY MODEL NO.	GRAY EPOXY MODEL NO.	BLACK EPOXY MODEL NO.		CHROME MODEL NO.	STAINLESS MODEL NO.	SHIP WGT	GALVANIZED MODEL NO.	STAINLESS MODEL NO.	SHIP WGT					
<b>2 Wire Shelf Utility Cart</b>												<b>1 Wire and 1 Solid Shelf Utility Cart</b>			<b>2 Solid Shelf Utility Cart</b>		
18" x 30" x 37-1/2"	WRC-1830-2	WRSC-1830-2	WRC-1830P-2	WRC-1830GY-2	WRC-1830BK-2	34 lbs	WRC-1830-2CG	WRSC-1830SS-2S	40 lbs	WRC-1830-2G	WRSC-1830-2SS	48 lbs					
18" x 36" x 37-1/2"	WRC-1836-2	WRSC-1836-2	WRC-1836P-2	WRC-1836GY-2	WRC-1836BK-2	38 lbs	WRC-1836-2CG	WRSC-1836SS-2S	44 lbs	WRC-1836-2G	WRSC-1836-2SS	50 lbs					
18" x 42" x 37-1/2"	WRC-1842-2	WRSC-1842-2	WRC-1842P-2	WRC-1842GY-2	WRC-1842BK-2	40 lbs	WRC-1842-2CG	WRSC-1842SS-2S	47 lbs	WRC-1842-2G	WRSC-1842-2SS	54 lbs					
18" x 48" x 37-1/2"	WRC-1848-2	WRSC-1848-2	WRC-1848P-2	WRC-1848GY-2	WRC-1848BK-2	46 lbs	WRC-1848-2CG	WRSC-1848SS-2S	52 lbs	WRC-1848-2G	WRSC-1848-2SS	58 lbs					
18" x 60" x 37-1/2"	WRC-1860-2	WRSC-1860-2	WRC-1860P-2	WRC-1860GY-2	WRC-1860BK-2	52 lbs	WRC-1860-2CG	WRSC-1860SS-2S	59 lbs	WRC-1860-2G	WRSC-1860-2SS	68 lbs					
21" x 30" x 37-1/2"	WRC-2130-2	WRSC-2130-2	WRC-2130P-2	WRC-2130GY-2	-	38 lbs	WRC-2130-2CG	WRSC-2130SS-2S	44 lbs	WRC-2130-2G	WRSC-2130-2SS	52 lbs					
21" x 36" x 37-1/2"	WRC-2136-2	WRSC-2136-2	WRC-2136P-2	WRC-2136GY-2	-	42 lbs	WRC-2136-2CG	WRSC-2136SS-2S	49 lbs	WRC-2136-2G	WRSC-2136-2SS	58 lbs					
21" x 42" x 37-1/2"	WRC-2142-2	WRSC-2142-2	WRC-2142P-2	WRC-2142GY-2	-	44 lbs	WRC-2142-2CG	WRSC-2142SS-2S	53 lbs	WRC-2142-2G	WRSC-2142-2SS	64 lbs					
21" x 48" x 37-1/2"	WRC-2148-2	WRSC-2148-2	WRC-2148P-2	WRC-2148GY-2	-	48 lbs	WRC-2148-2CG	WRSC-2148SS-2S	57 lbs	WRC-2148-2G	WRSC-2148-2SS	68 lbs					
21" x 60" x 37-1/2"	WRC-2160-2	WRSC-2160-2	WRC-2160P-2	WRC-2160GY-2	-	56 lbs	WRC-2160-2CG	WRSC-2160SS-2S	66 lbs	WRC-2160-2G	WRSC-2160-2SS	78 lbs					
24" x 30" x 37-1/2"	WRC-2430-2	WRSC-2430-2	WRC-2430P-2	WRC-2430GY-2	WRC-2430BK-2	42 lbs	WRC-2430-2CG	WRSC-2430SS-2S	48 lbs	WRC-2430-2G	WRSC-2430-2SS	56 lbs					
24" x 36" x 37-1/2"	WRC-2436-2	WRSC-2436-2	WRC-2436P-2	WRC-2436GY-2	WRC-2436BK-2	46 lbs	WRC-2436-2CG	WRSC-2436SS-2S	52 lbs	WRC-2436-2G	WRSC-2436-2SS	60 lbs					
24" x 42" x 37-1/2"	WRC-2442-2	WRSC-2442-2	WRC-2442P-2	WRC-2442GY-2	WRC-2442BK-2	50 lbs	WRC-2442-2CG	WRSC-2442SS-2S	57 lbs	WRC-2442-2G	WRSC-2442-2SS	66 lbs					
24" x 48" x 37-1/2"	WRC-2448-2	WRSC-2448-2	WRC-2448P-2	WRC-2448GY-2	WRC-2448BK-2	52 lbs	WRC-2448-2CG	WRSC-2448SS-2S	60 lbs	WRC-2448-2G	WRSC-2448-2SS	68 lbs					
24" x 60" x 37-1/2"	WRC-2460-2	WRSC-2460-2	WRC-2460P-2	WRC-2460GY-2	WRC-2460BK-2	62 lbs	WRC-2460-2CG	WRSC-2460SS-2S	72 lbs	WRC-2460-2G	WRSC-2460-2SS	84 lbs					
<b>3 Wire Shelf Utility Cart</b>												<b>2 Wire and 1 Solid Shelf Utility Cart</b>			<b>3 Solid Shelf Utility Cart</b>		
18" x 30" x 37-1/2"	WRC-1830-3	WRSC-1830-3	WRC-1830P-3	WRC-1830GY-3	WRC-1830BK-3	42 lbs	WRC-1830-3CG	WRSC-1830SS-3S	48 lbs	WRC-1830-3G	WRSC-1830-3SS	62 lbs					
18" x 36" x 37-1/2"	WRC-1836-3	WRSC-1836-3	WRC-1836P-3	WRC-1836GY-3	WRC-1836BK-3	48 lbs	WRC-1836-3CG	WRSC-1836SS-3S	54 lbs	WRC-1836-3G	WRSC-1836-3SS	66 lbs					
18" x 42" x 37-1/2"	WRC-1842-3	WRSC-1842-3	WRC-1842P-3	WRC-1842GY-3	WRC-1842BK-3	51 lbs	WRC-1842-3CG	WRSC-1842SS-3S	58 lbs	WRC-1842-3G	WRSC-1842-3SS	72 lbs					
18" x 48" x 37-1/2"	WRC-1848-3	WRSC-1848-3	WRC-1848P-3	WRC-1848GY-3	WRC-1848BK-3	60 lbs	WRC-1848-3CG	WRSC-1848SS-3S	66 lbs	WRC-1848-3G	WRSC-1848-3SS	78 lbs					
18" x 60" x 37-1/2"	WRC-1860-3	WRSC-1860-3	WRC-1860P-3	WRC-1860GY-3	WRC-1860BK-3	69 lbs	WRC-1860-3CG	WRSC-1860SS-3S	76 lbs	WRC-1860-3G	WRSC-1860-3SS	92 lbs					
21" x 30" x 37-1/2"	WRC-2130-3	WRSC-2130-3	WRC-2130P-3	WRC-2130GY-3	-	47 lbs	WRC-2130-3CG	WRSC-2130SS-3S	53 lbs	WRC-2130-3G	WRSC-2130-3SS	67 lbs					
21" x 36" x 37-1/2"	WRC-2136-3	WRSC-2136-3	WRC-2136P-3	WRC-2136GY-3	-	53 lbs	WRC-2136-3CG	WRSC-2136SS-3S	60 lbs	WRC-2136-3G	WRSC-2136-3SS	76 lbs					
21" x 42" x 37-1/2"	WRC-2142-3	WRSC-2142-3	WRC-2142P-3	WRC-2142GY-3	-	56 lbs	WRC-2142-3CG	WRSC-2142SS-3S	65 lbs	WRC-2142-3G	WRSC-2142-3SS	85 lbs					
21" x 48" x 37-1/2"	WRC-2148-3	WRSC-2148-3	WRC-2148P-3	WRC-2148GY-3	-	62 lbs	WRC-2148-3CG	WRSC-2148SS-3S	71 lbs	WRC-2148-3G	WRSC-2148-3SS	91 lbs					
21" x 60" x 37-1/2"	WRC-2160-3	WRSC-2160-3	WRC-2160P-3	WRC-2160GY-3	-	74 lbs	WRC-2160-3CG	WRSC-2160SS-3S	84 lbs	WRC-2160-3G	WRSC-2160-3SS	106 lbs					
24" x 30" x 37-1/2"	WRC-2430-3	WRSC-2430-3	WRC-2430P-3	WRC-2430GY-3	WRC-2430BK-3	53 lbs	WRC-2430-3CG	WRSC-2430SS-3S	59 lbs	WRC-2430-3G	WRSC-2430-3SS	73 lbs					
24" x 36" x 37-1/2"	WRC-2436-3	WRSC-2436-3	WRC-2436P-3	WRC-2436GY-3	WRC-2436BK-3	59 lbs	WRC-2436-3CG	WRSC-2436SS-3S	65 lbs	WRC-2436-3G	WRSC-2436-3SS	79 lbs					
24" x 42" x 37-1/2"	WRC-2442-3	WRSC-2442-3	WRC-2442P-3	WRC-2442GY-3	WRC-2442BK-3	65 lbs	WRC-2442-3CG	WRSC-2442SS-3S	72 lbs	WRC-2442-3G	WRSC-2442-3SS	88 lbs					
24" x 48" x 37-1/2"	WRC-2448-3	WRSC-2448-3	WRC-2448P-3	WRC-2448GY-3	WRC-2448BK-3	68 lbs	WRC-2448-3CG	WRSC-2448SS-3S	76 lbs	WRC-2448-3G	WRSC-2448-3SS	92 lbs					
24" x 60" x 37-1/2"	WRC-2460-3	WRSC-2460-3	WRC-2460P-3	WRC-2460GY-3	WRC-2460BK-3	83 lbs	WRC-2460-3CG	WRSC-2460SS-3S	93 lbs	WRC-2460-3G	WRSC-2460-3SS	115 lbs					

Push Handle Wire Utility Carts

**NEW**

Give versatility to any operation: food service, hospitals and maintenance. Carts consists of 1 push handle, 4 donut bumpers, 4 swivel casters (2 with brakes) and wire or solid shelf combinations. **Finishes:** Chrome, Stainless Steel, Green, Gray and Black Epoxy

**Up to 1,200 lb.**  
MOBILE LOAD CAPACITY

**UTILITY CARTS**  
IN ANY STYLE, FINISH, OR CONFIGURATION



**WRCP-1836GY-2**  
Gray Epoxy Wire



**WRCP-1836GN-3**  
Green Epoxy Wire



**WRCP-1836BK-3**  
Black Epoxy Wire

DIMENSIONS W" x L" x H"	WIRE SHELF						WIRE & SOLID SHELF			SOLID SHELF		
	CHROME MODEL NO.	STAINLESS MODEL NO.	PROFORM GREEN EPOXY MODEL NO.	GRAY EPOXY MODEL NO.	BLACK EPOXY MODEL NO.	SHIP WGT	CHROME MODEL NO.	STAINLESS MODEL NO.	SHIP WGT	GALVANIZED MODEL NO.	STAINLESS MODEL NO.	SHIP WGT
	<b>2 Wire Shelf Push Handle Utility Cart</b>						<b>1 Wire and 1 Solid Shelf Push Handle Utility Cart</b>			<b>2 Solid Shelf Push Handle Utility Cart</b>		
18" x 30" x 40"	WRCP-1830-2	WRSCP-1830-2	WRCP-1830P-2	WRCP-1830GY-2	WRCP-1830BK-2	40 lbs	WRCP-1830-2CG	WRSCP-1830SS-2S	46 lbs	WRCP-1830-2G	WRSCP-1830-2SS	52 lbs
18" x 36" x 40"	WRCP-1836-2	WRSCP-1836-2	WRCP-1836P-2	WRCP-1836GY-2	WRCP-1836BK-2	44 lbs	WRCP-1836-2CG	WRSCP-1836SS-2S	50 lbs	WRCP-1836-2G	WRSCP-1836-2SS	56 lbs
18" x 42" x 40"	WRCP-1842-2	WRSCP-1842-2	WRCP-1842P-2	WRCP-1842GY-2	WRCP-1842BK-2	46 lbs	WRCP-1842-2CG	WRSCP-1842SS-2S	53 lbs	WRCP-1842-2G	WRSCP-1842-2SS	60 lbs
18" x 48" x 40"	WRCP-1848-2	WRSCP-1848-2	WRCP-1848P-2	WRCP-1848GY-2	WRCP-1848BK-2	52 lbs	WRCP-1848-2CG	WRSCP-1848SS-2S	58 lbs	WRCP-1848-2G	WRSCP-1848-2SS	64 lbs
18" x 60" x 40"	WRCP-1860-2	WRSCP-1860-2	WRCP-1860P-2	WRCP-1860GY-2	WRCP-1860BK-2	58 lbs	WRCP-1860-2CG	WRSCP-1860SS-2S	65 lbs	WRCP-1860-2G	WRSCP-1860-2SS	72 lbs
21" x 30" x 40"	WRCP-2130-2	WRSCP-2130-2	WRCP-2130P-2	WRCP-2130GY-2	-	43 lbs	WRCP-2130-2CG	WRSCP-2130SS-2S	49 lbs	WRCP-2130-2G	WRSCP-2130-2SS	55 lbs
21" x 36" x 40"	WRCP-2136-2	WRSCP-2136-2	WRCP-2136P-2	WRCP-2136GY-2	-	47 lbs	WRCP-2136-2CG	WRSCP-2136SS-2S	54 lbs	WRCP-2136-2G	WRSCP-2136-2SS	61 lbs
21" x 42" x 40"	WRCP-2142-2	WRSCP-2142-2	WRCP-2142P-2	WRCP-2142GY-2	-	49 lbs	WRCP-2142-2CG	WRSCP-2142SS-2S	58 lbs	WRCP-2142-2G	WRSCP-2142-2SS	67 lbs
21" x 48" x 40"	WRCP-2148-2	WRSCP-2148-2	WRCP-2148P-2	WRCP-2148GY-2	-	53 lbs	WRCP-2148-2CG	WRSCP-2148SS-2S	62 lbs	WRCP-2148-2G	WRSCP-2148-2SS	71 lbs
21" x 60" x 40"	WRCP-2160-2	WRSCP-2160-2	WRCP-2160P-2	WRCP-2160GY-2	-	61 lbs	WRCP-2160-2CG	WRSCP-2160SS-2S	71 lbs	WRCP-2160-2G	WRSCP-2160-2SS	81 lbs
24" x 30" x 40"	WRCP-2430-2	WRSCP-2430-2	WRCP-2430P-2	WRCP-2430GY-2	WRCP-2430BK-2	47 lbs	WRCP-2430-2CG	WRSCP-2430SS-2S	53 lbs	WRCP-2430-2G	WRSCP-2430-2SS	59 lbs
24" x 36" x 40"	WRCP-2436-2	WRSCP-2436-2	WRCP-2436P-2	WRCP-2436GY-2	WRCP-2436BK-2	51 lbs	WRCP-2436-2CG	WRSCP-2436SS-2S	57 lbs	WRCP-2436-2G	WRSCP-2436-2SS	63 lbs
24" x 42" x 40"	WRCP-2442-2	WRSCP-2442-2	WRCP-2442P-2	WRCP-2442GY-2	WRCP-2442BK-2	55 lbs	WRCP-2442-2CG	WRSCP-2442SS-2S	62 lbs	WRCP-2442-2G	WRSCP-2442-2SS	69 lbs
24" x 48" x 40"	WRCP-2448-2	WRSCP-2448-2	WRCP-2448P-2	WRCP-2448GY-2	WRCP-2448BK-2	57 lbs	WRCP-2448-2CG	WRSCP-2448SS-2S	65 lbs	WRCP-2448-2G	WRSCP-2448-2SS	73 lbs
24" x 60" x 40"	WRCP-2460-2	WRSCP-2460-2	WRCP-2460P-2	WRCP-2460GY-2	WRCP-2460BK-2	67 lbs	WRCP-2460-2CG	WRSCP-2460SS-2S	77 lbs	WRCP-2460-2G	WRSCP-2460-2SS	87 lbs
	<b>3 Wire Shelf Push Handle Utility Cart</b>						<b>2 Wire and 1 Solid Shelf Push Handle Utility Cart</b>			<b>3 Solid Shelf Push Handle Utility Cart</b>		
18" x 30" x 40"	WRCP-1830-3	WRSCP-1830-3	WRCP-1830P-3	WRCP-1830GY-3	WRCP-1830BK-3	48 lbs	WRCP-1830-3CG	WRSCP-1830SS-3S	54 lbs	WRCP-1830-3G	WRSCP-1830-3SS	66 lbs
18" x 36" x 40"	WRCP-1836-3	WRSCP-1836-3	WRCP-1836P-3	WRCP-1836GY-3	WRCP-1836BK-3	54 lbs	WRCP-1836-3CG	WRSCP-1836SS-3S	60 lbs	WRCP-1836-3G	WRSCP-1836-3SS	72 lbs
18" x 42" x 40"	WRCP-1842-3	WRSCP-1842-3	WRCP-1842P-3	WRCP-1842GY-3	WRCP-1842BK-3	57 lbs	WRCP-1842-3CG	WRSCP-1842SS-3S	64 lbs	WRCP-1842-3G	WRSCP-1842-3SS	78 lbs
18" x 48" x 40"	WRCP-1848-3	WRSCP-1848-3	WRCP-1848P-3	WRCP-1848GY-3	WRCP-1848BK-3	66 lbs	WRCP-1848-3CG	WRSCP-1848SS-3S	72 lbs	WRCP-1848-3G	WRSCP-1848-3SS	84 lbs
18" x 60" x 40"	WRCP-1860-3	WRSCP-1860-3	WRCP-1860P-3	WRCP-1860GY-3	WRCP-1860BK-3	75 lbs	WRCP-1860-3CG	WRSCP-1860SS-3S	82 lbs	WRCP-1860-3G	WRSCP-1860-3SS	96 lbs
21" x 30" x 40"	WRCP-2130-3	WRSCP-2130-3	WRCP-2130P-3	WRCP-2130GY-3	-	52 lbs	WRCP-2130-3CG	WRSCP-2130SS-3S	58 lbs	WRCP-2130-3G	WRSCP-2130-3SS	70 lbs
21" x 36" x 40"	WRCP-2136-3	WRSCP-2136-3	WRCP-2136P-3	WRCP-2136GY-3	-	58 lbs	WRCP-2136-3CG	WRSCP-2136SS-3S	65 lbs	WRCP-2136-3G	WRSCP-2136-3SS	79 lbs
21" x 42" x 40"	WRCP-2142-3	WRSCP-2142-3	WRCP-2142P-3	WRCP-2142GY-3	-	61 lbs	WRCP-2142-3CG	WRSCP-2142SS-3S	70 lbs	WRCP-2142-3G	WRSCP-2142-3SS	88 lbs
21" x 48" x 40"	WRCP-2148-3	WRSCP-2148-3	WRCP-2148P-3	WRCP-2148GY-3	-	67 lbs	WRCP-2148-3CG	WRSCP-2148SS-3S	76 lbs	WRCP-2148-3G	WRSCP-2148-3SS	94 lbs
21" x 60" x 40"	WRCP-2160-3	WRSCP-2160-3	WRCP-2160P-3	WRCP-2160GY-3	-	79 lbs	WRCP-2160-3CG	WRSCP-2160SS-3S	84 lbs	WRCP-2160-3G	WRSCP-2160-3SS	109 lbs
24" x 30" x 40"	WRCP-2430-3	WRSCP-2430-3	WRCP-2430P-3	WRCP-2430GY-3	WRCP-2430BK-3	58 lbs	WRCP-2430-3CG	WRSCP-2430SS-3S	64 lbs	WRCP-2430-3G	WRSCP-2430-3SS	76 lbs
24" x 36" x 40"	WRCP-2436-3	WRSCP-2436-3	WRCP-2436P-3	WRCP-2436GY-3	WRCP-2436BK-3	64 lbs	WRCP-2436-3CG	WRSCP-2436SS-3S	70 lbs	WRCP-2436-3G	WRSCP-2436-3SS	82 lbs
24" x 42" x 40"	WRCP-2442-3	WRSCP-2442-3	WRCP-2442P-3	WRCP-2442GY-3	WRCP-2442BK-3	70 lbs	WRCP-2442-3CG	WRSCP-2442SS-3S	77 lbs	WRCP-2442-3G	WRSCP-2442-3SS	91 lbs
24" x 48" x 40"	WRCP-2448-3	WRSCP-2448-3	WRCP-2448P-3	WRCP-2448GY-3	WRCP-2448BK-3	73 lbs	WRCP-2448-3CG	WRSCP-2448SS-3S	81 lbs	WRCP-2448-3G	WRSCP-2448-3SS	97 lbs
24" x 60" x 40"	WRCP-2460-3	WRSCP-2460-3	WRCP-2460P-3	WRCP-2460GY-3	WRCP-2460BK-3	88 lbs	WRCP-2460-3CG	WRSCP-2460SS-3S	98 lbs	WRCP-2460-3G	WRSCP-2460-3SS	118 lbs

**Cart Covers**

Protect against pilferage, airborne dust, water, and other contaminants. Velcro and zipper flap are available in clear-vinyl and blue and white denier nylon fabric. Clear vinyl is 10 gauge. Blue and white nylon fabric is 400 Denier. Specify zipper or velcro for closure.

**CART COVERS OPTIONS AVAILABLE**

- Custom sizes
- Hand openings
- Handle holes/slots
- Bottom tie tapes (*attach to posts*)
- Extra velcro strips
- Double flap
- Clear front flap
- Metal grommets
- 9" x 12" pocket/document holder
- Custom logos

**TO ORDER:**

1. Choose size
2. Select color:  
 Clear Vinyl add suffix CV  
 Blue Nylon add suffix BN  
 White Nylon add suffix WN
3. Choose Zipper or Velcro



CLEAR VINYL

**COVERS PROTECT AGAINST PILFERAGE, AIRBORNE DUST, MOISTURE AND OTHER CONTAMINANTS**

**CUSTOM SIZES AND ADDITIONAL COLORS ALONG WITH ESD/CONDUCTIVE MATERIAL AVAILABLE**

call for details



BLUE NYLON



WHITE NYLON

63"H - CART COVER				74"H - CART COVER			
DIMENSIONS W" x L" x H"	SHIP WGT	400 DENIER MODEL NO.	CLEAR VINYL MODEL NO.	DIMENSIONS W" x L" x H"	SHIP WGT	400 DENIER MODEL NO.	CLEAR VINYL MODEL NO.
18" x 36" x 63"	3 lbs	CC183663	CC183663CV	18" x 36" x 74"	4 lbs	CC183674	CC183674CV
18" x 48" x 63"	4 lbs	CC184863	CC184863CV	18" x 48" x 74"	5 lbs	CC184874	CC184874CV
18" x 60" x 63"	5 lbs	CC186063	CC186063CV	18" x 60" x 74"	6 lbs	CC186074	CC186074CV
18" x 72" x 63"	6 lbs	CC187263	CC187263CV	18" x 72" x 74"	7 lbs	CC187274	CC187274CV
24" x 36" x 63"	3 lbs	CC243663	CC243663CV	24" x 36" x 74"	4 lbs	CC243674	CC243674CV
24" x 48" x 63"	4 lbs	CC244863	CC244863CV	24" x 48" x 74"	5 lbs	CC244874	CC244874CV
24" x 60" x 63"	5 lbs	CC246063	CC246063CV	24" x 60" x 74"	6 lbs	CC246074	CC246074CV
24" x 72" x 63"	6 lbs	CC247263	CC247263CV	24" x 72" x 74"	7 lbs	CC247274	CC247274CV



**M1836C46**

## CHROME & EPOXY WIRE SHELVES

DIMENSIONS W" x L" x H"	4 SHELF CARTS		5 SHELF CARTS	
	MODEL NO.	SHIP WGT	MODEL NO.	SHIP WGT
<b>63"H - Post, 5" Stem Caster Carts</b>				
18" x 36" x 69"	<b>M1836C46</b>	68 lbs	<b>M1836C46-5</b>	72 lbs
18" x 48" x 69"	<b>M1848C46</b>	76 lbs	<b>M1848C46-5</b>	84 lbs
18" x 60" x 69"	<b>M1860C46</b>	97 lbs	<b>M1860C46-5</b>	107 lbs
24" x 36" x 69"	<b>M2436C46</b>	80 lbs	<b>M2436C46-5</b>	87 lbs
24" x 48" x 69"	<b>M2448C46</b>	94 lbs	<b>M2448C46-5</b>	102 lbs
24" x 60" x 69"	<b>M2460C46</b>	116 lbs	<b>M2460C46-5</b>	127 lbs
<b>74"H - Post, 5" Stem Caster Carts</b>				
18" x 36" x 80"	<b>M1836C47</b>	70 lbs	<b>M1836C47-5</b>	74 lbs
18" x 48" x 80"	<b>M1848C47</b>	78 lbs	<b>M1848C47-5</b>	86 lbs
18" x 60" x 80"	<b>M1860C47</b>	99 lbs	<b>M1860C47-5</b>	109 lbs
24" x 36" x 80"	<b>M2436C47</b>	82 lbs	<b>M2436C47-5</b>	89 lbs
24" x 48" x 80"	<b>M2448C47</b>	96 lbs	<b>M2448C47-5</b>	104 lbs
24" x 60" x 80"	<b>M2460C47</b>	118 lbs	<b>M2460C47-5</b>	129 lbs

- GREEN EPOXY
- GRAY EPOXY
- BLACK EPOXY

REPLACE "C" in Model No. to order Epoxy Finish

Ex. **M1836P46**  
**M1836GY46**  
**M1836BK46**

Stem Caster Carts



4 or 5 Wire Shelf Mobile Carts

**NEW**  
FINISH

Mobile wire stem caster carts add versatility and flexibility to any operation, creating a transport system. **Finishes:** Chrome, Green, Gray and Black Epoxy

- Supply and distribution
- Stock rotation
- Laundry
- Staging

Each unit consists of:

- 4 - posts
- 4 or 5 - wire shelves
- 4 - donut bumpers
- 4 - 5" thermoplastic resin casters, 2 with brakes



**M1836CG46-5**

## CHROME WIRE AND 18 GAUGE SOLID GALVANIZED STEEL SHELVES

DIMENSIONS W" x L" x H"	4 SHELF CARTS		5 SHELF CARTS	
	MODEL NO.	SHIP WGT	MODEL NO.	SHIP WGT
<b>63"H - Post, 5" Stem Caster Carts</b>				
18" x 36" x 69"	<b>M1836CG46</b>	68 lbs	<b>M1836CG46-5</b>	78 lbs
18" x 48" x 69"	<b>M1848CG46</b>	76 lbs	<b>M1848CG46-5</b>	90 lbs
18" x 60" x 69"	<b>M1860CG46</b>	97 lbs	<b>M1860CG46-5</b>	114 lbs
24" x 36" x 69"	<b>M2436CG46</b>	80 lbs	<b>M2436CG46-5</b>	93 lbs
24" x 48" x 69"	<b>M2448CG46</b>	94 lbs	<b>M2448CG46-5</b>	110 lbs
24" x 60" x 69"	<b>M2460CG46</b>	116 lbs	<b>M2460CG46-5</b>	137 lbs
<b>74"H - Post, 5" Stem Caster Carts</b>				
18" x 36" x 80"	<b>M1836CG47</b>	70 lbs	<b>M1836CG47-5</b>	80 lbs
18" x 48" x 80"	<b>M1848CG47</b>	78 lbs	<b>M1848CG47-5</b>	92 lbs
18" x 60" x 80"	<b>M1860CG47</b>	99 lbs	<b>M1860CG47-5</b>	116 lbs
24" x 36" x 80"	<b>M2436CG47</b>	82 lbs	<b>M2436CG47-5</b>	95 lbs
24" x 48" x 80"	<b>M2448CG47</b>	96 lbs	<b>M2448CG47-5</b>	112 lbs
24" x 60" x 80"	<b>M2460CG47</b>	118 lbs	<b>M2460CG47-5</b>	139 lbs

3 or 4 Wire/1 Solid Shelf Mobile Carts

Stem caster cart with solid bottom shelf. The unique combination of wire and solid shelves allows for air circulation and high visibility. The solid shelf in the bottom position prevents dust and dirt to rise and contains spillage.

Each unit consists of:

- 4 - posts
- 3 or 4 - wire shelves
- 1 - solid shelf
- 4 - donut bumpers
- 4 - 5" thermoplastic resin casters, 2 with brakes



**M1836SG46**

## GALVANIZED & STAINLESS SOLID SHELVES

DIMENSIONS W" x L" x H"	4 SHELF CARTS		5 SHELF CARTS	
	MODEL NO.	SHIP WGT	MODEL NO.	SHIP WGT
<b>63"H - Post, 5" Stem Caster Carts</b>				
18" x 36" x 69"	<b>M1836SG46</b>	86 lbs	<b>M1836SG46-5</b>	102 lbs
18" x 48" x 69"	<b>M1848SG46</b>	102 lbs	<b>M1848SG46-5</b>	122 lbs
18" x 60" x 69"	<b>M1860SG46</b>	118 lbs	<b>M1860SG46-5</b>	142 lbs
24" x 36" x 69"	<b>M2436SG46</b>	98 lbs	<b>M2436SG46-5</b>	117 lbs
24" x 48" x 69"	<b>M2448SG46</b>	102 lbs	<b>M2448SG46-5</b>	126 lbs
24" x 60" x 69"	<b>M2460SG46</b>	146 lbs	<b>M2460SG46-5</b>	177 lbs
<b>74"H - Post, 5" Stem Caster Carts</b>				
18" x 36" x 80"	<b>M1836SG47</b>	88 lbs	<b>M1836SG47-5</b>	104 lbs
18" x 48" x 80"	<b>M1848SG47</b>	104 lbs	<b>M1848SG47-5</b>	124 lbs
18" x 60" x 80"	<b>M1860SG47</b>	120 lbs	<b>M1860SG47-5</b>	144 lbs
24" x 36" x 80"	<b>M2436SG47</b>	100 lbs	<b>M2436SG47-5</b>	119 lbs
24" x 48" x 80"	<b>M2448SG47</b>	104 lbs	<b>M2448SG47-5</b>	128 lbs
24" x 60" x 80"	<b>M2460SG47</b>	148 lbs	<b>M2460SG47-5</b>	179 lbs

- STAINLESS

REPLACE "SG" in Model No. to order Stainless Steel Finish

Ex. **M1836SS46**

**Up to 1,200 lb.**  
**MOBILE LOAD CAPACITY**

4 or 5 Solid Shelf Mobile Carts

Stem caster solid shelf cart is an easy way to transport tools and inventories. **Finishes:** Galvanized Steel and Stainless Steel

Each unit consists of:

- 4 - posts
- 4 or 5 - solid shelves
- 4 - donut bumpers
- 4 - 5" thermoplastic resin casters, 2 with brakes

Enclosure Carts



Enclosure carts are an effective way to keep contents from moving or falling off during transportation.

Enclosure carts using rods and tabs are adaptable to any shelf position.

Enclosure dolly base truck using rods and tabs allows for heavier load transport. The rods and tabs act as a perimeter to retain product.

For additional shelves, see *pg. 104*.

Each units consist of:

- 4 - posts
- 4 or 5 - wire shelves
- 4, 5 or 6 - rods and tabs kits

Mobile unit also includes:

- 4 - 5" swivel thermoplastic resin casters, 2 with brakes
- 4 - donut bumpers

Dolly Base unit also includes:

- 1 - dolly base
- 4 - plate thermoplastic resin casters (2 rigid and 2 swivel with brake)



M1836C46RE



MD1836C46RE-5

**COMPLETE CARTS INCLUDE CASTER KIT FOR MOBILITY**

**Up to 1,200 lb. MOBILE LOAD CAPACITY**

Rods & Tabs

Rods and tabs represent an economical, alternate solution for enclosure on backs and sides of mobile and stationary units.

Each kit includes:

- 3 - rods
- 9 - front/back tabs
- 9 - side/solid shelf tabs.

MODEL NO.	DESCRIPTION	SHIP WGT
<b>Rods &amp; Tabs</b>		
52RT	3 - 52" Rods with Tabs	1 lb
61RT	3 - 61" Rods with Tabs	1 lb
72RT	3 - 72" Rods with Tabs	2 lbs
84RT	3 - 84" Rods with Tabs	2 lbs



QSRT Side or Solid Shelf Tab



QAT Front or Back Tab

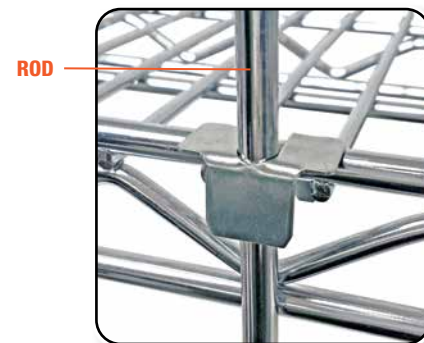

ROD

3 SIDED, 4 OR 5 WIRE SHELF CART WITH RODS AND TABS

DIMENSIONS W" x L" x H"	4 SHELF CARTS		5 SHELF CARTS	
	MODEL NO.	SHIP WGT	MODEL NO.	SHIP WGT
<b>63"H - Post, Cart with Rods and Tabs</b>				
18" x 36" x 69"	M1836C46RE	74 lbs	M1836C46RE-5	84 lbs
18" x 48" x 69"	M1848C46RE	84 lbs	M1848C46RE-5	98 lbs
18" x 60" x 69"	M1860C46RE	100 lbs	M1860C46RE-5	117 lbs
24" x 36" x 69"	M2436C46RE	88 lbs	M2436C46RE-5	101 lbs
24" x 48" x 69"	M2448C46RE	104 lbs	M2448C46RE-5	120 lbs
24" x 60" x 69"	M2460C46RE	124 lbs	M2460C46RE-5	145 lbs
<b>74"H - Post, Cart with Rods and Tabs</b>				
18" x 36" x 80"	M1836C47RE	80 lbs	M1836C47RE-5	90 lbs
18" x 48" x 80"	M1848C47RE	92 lbs	M1848C47RE-5	106 lbs
18" x 60" x 80"	M1860C47RE	104 lbs	M1860C47RE-5	121 lbs
24" x 36" x 80"	M2436C47RE	94 lbs	M2436C47RE-5	107 lbs
24" x 48" x 80"	M2448C47RE	112 lbs	M2448C47RE-5	128 lbs
24" x 60" x 80"	M2460C47RE	132 lbs	M2460C47RE-5	153 lbs

**CHROME WIRE SHELVES**

DOLLY BASE 3 SIDED, 4 OR 5 WIRE SHELF CART WITH RODS AND TABS

DIMENSIONS W" x L" x H"	4 SHELF CARTS		5 SHELF CARTS	
	MODEL NO.	SHIP WGT	MODEL NO.	SHIP WGT
<b>63"H - Post, Dolly Base Carts with Rods and Tabs</b>				
18" x 36" x 70"	MD1836C46RE	86 lbs	MD1836C46RE-5	96 lbs
18" x 48" x 70"	MD1848C46RE	96 lbs	MD1848C46RE-5	110 lbs
18" x 60" x 70"	MD1860C46RE	124 lbs	MD1860C46RE-5	141 lbs
24" x 36" x 70"	MD2436C46RE	113 lbs	MD2436C46RE-5	126 lbs
24" x 48" x 70"	MD2448C46RE	121 lbs	MD2448C46RE-5	137 lbs
24" x 60" x 70"	MD2460C46RE	144 lbs	MD2460C46RE-5	165 lbs
<b>74"H - Post, Dolly Base Carts with Rods and Tabs</b>				
18" x 36" x 81"	MD1836C47RE	92 lbs	MD1836C47RE-5	102 lbs
18" x 48" x 81"	MD1848C47RE	106 lbs	MD1848C47RE-5	120 lbs
18" x 60" x 81"	MD1860C47RE	120 lbs	MD1860C47RE-5	137 lbs
24" x 36" x 81"	MD2436C47RE	108 lbs	MD2436C47RE-5	121 lbs
24" x 48" x 81"	MD2448C47RE	129 lbs	MD2448C47RE-5	145 lbs
24" x 60" x 81"	MD2460C47RE	152 lbs	MD2460C47RE-5	173 lbs



**Enclosure Carts**

Enclosure carts are an effective way to keep contents from moving or falling off during transportation.

Enclosure carts using rods and tabs are adaptable to any shelf position.

Enclosure dolly base truck using rods and tabs allows for heavier load transport. The rods and tabs act as a perimeter to retain product.

For additional shelves, see *pg. 104*.

*Each units consist of:*

- 4 - posts
- 3 or 4 - wire shelves
- 1 - solid shelf
- 4, 5 or 6 - rods and tabs kits

*Mobile unit also includes:*

- 4 - 5" swivel thermoplastic resin casters, 2 with brakes
- 4 - donut bumpers

*Dolly Base unit also includes:*

- 1 - dolly base
- 4 - plate thermoplastic resin casters (2 rigid and 2 swivel with brake)

**COMPLETE CARTS INCLUDE CASTER KIT FOR MOBILITY**

**Up to 1,200 lb. MOBILE LOAD CAPACITY**

**NYLON FABRIC OR CLEAR VINYL CART COVERS AVAILABLE**

See *pg. 124*

**3 SIDED STEM CASTER WIRE SHELF CART WITH 3 OR 4 WIRE SHELVES AND 1 SOLID SHELF WITH RODS AND TABS**

DIMENSIONS W" x L" x H"	4 SHELF CARTS		5 SHELF CARTS	
	MODEL NO.	SHIP WGT	MODEL NO.	SHIP WGT
<b>63"H - Post, Cart with Rods and Tabs</b>				
18" x 36" x 69"	M1836CG46RE	83 lbs	M1836CG46RE-5	93 lbs
18" x 48" x 69"	M1848CG46RE	94 lbs	M1848CG46RE-5	108 lbs
18" x 60" x 69"	M1860CG46RE	114 lbs	M1860CG46RE-5	131 lbs
24" x 36" x 69"	M2436CG46RE	96 lbs	M2436CG46RE-5	109 lbs
24" x 48" x 69"	M2448CG46RE	112 lbs	M2448CG46RE-5	128 lbs
24" x 60" x 69"	M2460CG46RE	136 lbs	M2460CG46RE-5	157 lbs
<b>74"H - Post, Cart with Rods and Tabs</b>				
18" x 36" x 80"	M1836CG47RE	89 lbs	M1836CG47RE-5	99 lbs
18" x 48" x 80"	M1848CG47RE	101 lbs	M1848CG47RE-5	115 lbs
18" x 60" x 80"	M1860CG47RE	123 lbs	M1860CG47RE-5	140 lbs
24" x 36" x 80"	M2436CG47RE	102 lbs	M2436CG47RE-5	115 lbs
24" x 48" x 80"	M2448CG47RE	119 lbs	M2448CG47RE-5	135 lbs
24" x 60" x 80"	M2460CG47RE	144 lbs	M2460CG47RE-5	166 lbs



M1836CG46RE

**CHROME WIRE AND 18 GAUGE SOLID GALVANIZED STEEL SHELVES**

**DOLLY BASE 3 SIDED WIRE SHELF CART WITH 3 OR 4 WIRE SHELVES AND 1 SOLID SHELF WITH RODS AND TABS**

DIMENSIONS W" x L" x H"	4 SHELF CARTS		5 SHELF CARTS	
	MODEL NO.	SHIP WGT	MODEL NO.	SHIP WGT
<b>63"H - Post, Dolly Base Carts with Rods and Tabs</b>				
18" x 36" x 70"	MD1836CG46RE	93 lbs	MD1836CG46RE-5	102 lbs
18" x 48" x 70"	MD1848CG46RE	106 lbs	MD1848CG46RE-5	116 lbs
18" x 60" x 70"	MD1860CG46RE	128 lbs	MD1860CG46RE-5	147 lbs
24" x 36" x 70"	MD2436CG46RE	109 lbs	MD2436CG46RE-5	132 lbs
24" x 48" x 70"	MD2448CG46RE	127 lbs	MD2448CG46RE-5	145 lbs
24" x 60" x 70"	MD2460CG46RE	154 lbs	MD2460CG46RE-5	175 lbs
<b>74"H - Post, Dolly Base Carts with Rods and Tabs</b>				
18" x 36" x 81"	MD1836CG47RE	99 lbs	MD1836CG47RE-5	108 lbs
18" x 48" x 81"	MD1848CG47RE	113 lbs	MD1848CG47RE-5	126 lbs
18" x 60" x 81"	MD1860CG47RE	137 lbs	MD1860CG47RE-5	143 lbs
24" x 36" x 81"	MD2436CG47RE	115 lbs	MD2436CG47RE-5	127 lbs
24" x 48" x 81"	MD2448CG47RE	134 lbs	MD2448CG47RE-5	153 lbs
24" x 60" x 81"	MD2460CG47RE	163 lbs	MD2460CG47RE-5	183 lbs



MD1836CG46RE-5



WHITE NYLON

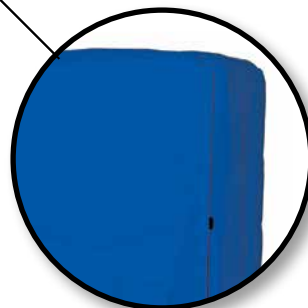

BLUE NYLON



CLEAR VINYL

**CART COVERS**

Protect against pilferage, airborne dust, moisture, and other contaminants

Enclosure Carts



Finishes: Chrome and Green Epoxy

Each unit consists of:

- 4 - posts
- 4 or 5 - wire shelves
- 4 - enclosure panels
- 4 - 5" swivel thermoplastic resin casters, 2 with brakes
- 4 - donut bumpers

**NEW FINISH**

**NYLON FABRIC OR CLEAR VINYL CART COVERS AVAILABLE**

See pg. 124



**BLUE NYLON CART COVER**

Protect against pilferage, airborne dust, moisture and other contaminants

Each units consist of:

- 4 - posts
- 3 or 4 - wire shelves
- 1 - solid shelf
- 4 or 5 - enclosure panels

Mobile unit also includes:

- 4 - 5" swivel thermoplastic resin casters, 2 with brakes
- 4 - donut bumpers

Dolly Base unit also includes:

- 1 - dolly base
- 4 - plate thermoplastic resin casters (2 rigid and 2 swivel with brake)

Add SUFFIX shown below to any Model No. to add Clear Label Holder package

- Ex. M2436C46E-LH33C
- Ex. M2436C46E-5LH33C

- 36" L ENCLOSURE CARTS
- 48" L ENCLOSURE CARTS
- 60" L ENCLOSURE CARTS



M2436C46E



WRCS4-63-2460EP-5



WRDBS4-63-2460EP

**CHROME & EPOXY WIRE SHELVES**

3 SIDED, 4 OR 5 WIRE SHELF CART WITH ENCLOSURE PANELS

DIMENSIONS W" x L" x H"	4 SHELF CARTS		5 SHELF CARTS	
	MODEL NO.	SHIP WGT	MODEL NO.	SHIP WGT
<b>63"H - Post, Cart with Enclosure Panels</b>				
24" x 36" x 69"	M2436C46E	145 lbs	M2436C46E-5	158 lbs
24" x 48" x 69"	M2448C46E	179 lbs	M2448C46E-5	195 lbs
24" x 60" x 69"	M2460C46E	197 lbs	M2460C46E-5	218 lbs

• GREEN EPOXY

REPLACE "C" in Model No. to order Epoxy Finish ▶ Ex. M2436P46E

**COMPLETE CARTS INCLUDE CASTER KIT FOR MOBILITY**

**Up to 1,200 lb. MOBILE LOAD CAPACITY**

3 SIDED STEM CASTER ENCLOSURE CART WITH 3 OR 4 WIRE SHELVES AND 1 SOLID SHELF WITH ENCLOSURE PANELS

DIMENSIONS W" x L" x H"	4 SHELF CARTS		5 SHELF CARTS	
	MODEL NO.	SHIP WGT	MODEL NO.	SHIP WGT
<b>63"H - Post, Cart with Solid Bottom Shelf and Enclosure Panels</b>				
24" x 36" x 69"	WRCS4-63-2436EP	113 lbs	WRCS4-63-2436EP-5	126 lbs
24" x 48" x 69"	WRCS4-63-2448EP	131 lbs	WRCS4-63-2448EP-5	147 lbs
24" x 60" x 69"	WRCS4-63-2460EP	158 lbs	WRCS4-63-2460EP-5	179 lbs
<b>74"H - Post, Cart with Solid Bottom Shelf and Enclosure Panels</b>				
24" x 36" x 80"	WRCS4-74-2436EP	113 lbs	WRCS4-74-2436EP-5	126 lbs
24" x 48" x 80"	WRCS4-74-2448EP	131 lbs	WRCS4-74-2448EP-5	147 lbs
24" x 60" x 80"	WRCS4-74-2460EP	158 lbs	WRCS4-74-2460EP-5	179 lbs

**CHROME WIRE AND 18 GAUGE SOLID GALVANIZED STEEL SHELVES**

3 SIDED DOLLY BASE ENCLOSURE CART WITH 3 OR 4 WIRE SHELVES AND 1 SOLID SHELF WITH ENCLOSURE PANELS

DIMENSIONS W" x L" x H"	4 SHELF CARTS		5 SHELF CARTS	
	MODEL NO.	SHIP WGT	MODEL NO.	SHIP WGT
<b>63"H - Post, Dolly Base Cart with Solid Bottom Shelf and Enclosure Panels</b>				
24" x 36" x 70"	WRDBS4-63-2436EP	124 lbs	WRDBS4-63-2436EP-5	137 lbs
24" x 48" x 70"	WRDBS4-63-2448EP	142 lbs	WRDBS4-63-2448EP-5	158 lbs
24" x 60" x 70"	WRDBS4-63-2460EP	169 lbs	WRDBS4-63-2460EP-5	190 lbs
<b>74"H - Post, Dolly Base Cart with Solid Bottom Shelf and Enclosure Panels</b>				
24" x 36" x 81"	WRDBS4-74-2436EP	124 lbs	WRDBS4-74-2436EP-5	137 lbs
24" x 48" x 81"	WRDBS4-74-2448EP	142 lbs	WRDBS4-74-2448EP-5	158 lbs
24" x 60" x 81"	WRDBS4-74-2460EP	169 lbs	WRDBS4-74-2460EP-5	190 lbs

**Security Units**

**NEW SIZES**

Stationary and Mobile Units prevent pilferage while allowing high visibility of contents at all times. All side and back panels are heavy gauge wire construction and are manufactured of all-welded heavy-duty 1/4" diameter wire on 2" x 2" centers. Assembly is quick and easy. **Finishes:** Chrome and Proform Green Epoxy

**WANT TO SECURE YOUR EXISTING SHELVING UNITS?**



Thick wire gauge ensures strong and dependable security yet easy visibility



2436-63SECP-2

**NYLON FABRIC OR CLEAR VINYL UNIT COVERS AVAILABLE FOR ALL SECURITY UNITS** See pg. 124

**Stationary Security Units**

- Each unit consists of:
- 4 - posts
  - 2 - wire shelves (for top and bottom)
  - 1 - security panel set (includes back and sides)
  - 1 - pair security panel doors

MODEL NO.	DIMENSIONS W" x L" x H"	SHIP WGT
<b>Stationary Security Units</b>		
1836-63SEC	18" x 36" x 63"	145 lbs
1848-63SEC	18" x 48" x 63"	172 lbs
1860-63SEC	18" x 60" x 63"	204 lbs
2136-63SEC	21" x 36" x 63"	155 lbs
2148-63SEC	21" x 48" x 63"	162 lbs
2160-63SEC	21" x 60" x 63"	214 lbs
2436-63SEC	24" x 36" x 63"	165 lbs
2448-63SEC	24" x 48" x 63"	192 lbs
2460-63SEC	24" x 60" x 63"	224 lbs

**ADD SUFFIX "P" TO MODEL NO. TO ORDER GREEN EPOXY FINISH**

Ex. 2436-63SECP

Intermediate shelves can be purchased separately for all security units see pg. 104. To order unit with 2 intermediate shelves included, add -2 to the end of each model no.

Ex. 2436-63SEC-2  
2436-63SECP-2

**Security Panel Doors**

Each door set has left and right panel with 4 hinge bars. Assembly is quick and easy and adapts to the appropriate shelf size, with standard post of 63" high.

CHROME MODEL NO.	GREEN EPOXY MODEL NO.	DIMENSIONS W" x L" x H"	SHIP WGT
<b>Security Panel Door Set with Hinges</b>			
SD36-18C	SD36-18P	18" x 36" x 60"	64 lbs
SD48-18C	SD48-18P	18" x 48" x 60"	76 lbs
SD60-18C	SD60-18P	18" x 60" x 60"	88 lbs
SD36-21C	SD36-21P	21" x 36" x 60"	66 lbs
SD48-21C	SD48-21P	21" x 48" x 60"	78 lbs
SD60-21C	SD60-21P	21" x 60" x 60"	90 lbs
SD36-24C	SD36-24P	24" x 36" x 60"	67 lbs
SD48-24C	SD48-24P	24" x 48" x 60"	79 lbs
SD60-24C	SD60-24P	24" x 60" x 60"	91 lbs



DOOR TOP SECURITY



DOOR MIDDLE SECURITY



DOOR BOTTOM SECURITY



M2436-69SEC

**Stem Caster Security Carts**

Mobility adds flexibility to a unit and is beneficial in all types of operations.

- Each unit consists of:
- 4 - posts
  - 2 - wire shelves (for top and bottom)
  - 1 - security panel set (includes back and sides)
  - 1 - pair security panel doors
  - 4 - 5" thermoplastic resin casters, 2 with brake
  - 4 - donut bumpers

MODEL NO.	DIMENSIONS W" x L" x H"	SHIP WGT
<b>Stem Caster Security Carts</b>		
M1836-69SEC	18" x 36" x 69"	153 lbs
M1848-69SEC	18" x 48" x 69"	180 lbs
M1860-69SEC	18" x 60" x 69"	212 lbs
M2136-69SEC	21" x 36" x 69"	163 lbs
M2148-69SEC	21" x 48" x 69"	190 lbs
M2160-69SEC	21" x 60" x 69"	222 lbs
M2436-69SEC	24" x 36" x 69"	173 lbs
M2448-69SEC	24" x 48" x 69"	200 lbs
M2460-69SEC	24" x 60" x 69"	232 lbs

**Security Panel Sets**

Panels allow maximum security for standard shelving units. Panels are fabricated from all-welded wire and include joined back portion and two side portions.

CHROME MODEL NO.	GREEN EPOXY MODEL NO.	DIMENSIONS W" x L" x H"	SHIP WGT
<b>Security Enclosure Panel Set</b>			
183660EPC	183660EPP	18" x 36" x 60"	60 lbs
184860EPC	184860EPP	18" x 48" x 60"	67 lbs
186060EPC	186060EPP	18" x 60" x 60"	77 lbs
213660EPC	213660EPP	21" x 36" x 60"	64 lbs
214860EPC	214860EPP	21" x 48" x 60"	71 lbs
216060EPC	216060EPP	21" x 60" x 60"	81 lbs
243660EPC	243660EPP	24" x 36" x 60"	70 lbs
244860EPC	244860EPP	24" x 48" x 60"	80 lbs
246060EPC	246060EPP	24" x 60" x 60"	90 lbs

**Up to 1,200 lb. MOBILE LOAD CAPACITY**



MD2436-70SEC

**Dolly Base Security Carts**

Dollies can add stability and support in heavy-duty load applications.

- Each unit consists of:
- 4 - posts
  - 2 - wire shelves (for top and bottom)
  - 1 - security panel set (includes back and sides)
  - 1 - pair security panel doors
  - 1 - dolly base
  - 4 - plate thermoplastic resin casters (2 rigid and 2 swivel with brake)

MODEL NO.	DIMENSIONS W" x L" x H"	SHIP WGT
<b>Dolly Base Security Carts</b>		
MD1836-70SEC	18" x 36" x 70"	165 lbs
MD1848-70SEC	18" x 48" x 70"	194 lbs
MD1860-70SEC	18" x 60" x 70"	228 lbs
MD2436-70SEC	24" x 36" x 70"	186 lbs
MD2448-70SEC	24" x 48" x 70"	215 lbs
MD2460-70SEC	24" x 60" x 70"	250 lbs

**High Density Sliding Floor Track System**



High Density Sliding Track System offers a unique way to maximize and efficiently move wire shelving systems. The patented design allows for quick and easy installation. Bearings in the skate are located under each post for a load capacity of up to 1,500 lb. per shelving unit. The v-groove floor track allows the shelving unit to slide back and forth with ease. Layout assistance is available.

**PERFORMANCE FEATURES AND BENEFITS:**

- Low shipping cost
- NSF approved
- Uses industrial bearings
- Corrosion free construction
- Easy to roll construction
- Fast installation
- Utilizes the structure of existing shelving
- Complies with ADA regulations
- Up to 1,500 lb. load capacity per unit
- Can increase storage areas up to 150%



**SYSTEMS SLIDE BACK AND FORTH WITH EASE**

**QESTP End Stop Kit**

Includes 2 ends and 1 drill bit. Serves the dual purpose of stopping a skate and is the anchor for the track. Manufactured from shock absorbing polymer. One kit is required per track.

**QVTRK V-Groove Track**

Aluminum design with 304 stainless steel inserts with a gradual taper, non-tripping hazard, 7/16" max height. (Sold by the inch)

**HD18 - HD36 One Skate**

Aluminum with engineered plastic wheel housing and industrial up to 2,000 lb. capacity bearings on each end.

**DR Drift Resistor**  
Reduces speed and impact.

**WK Wing Kit**

Includes four 1/4" thick aluminum plates and hardware and allows for the joining of 2 units side by side, sharing one track.

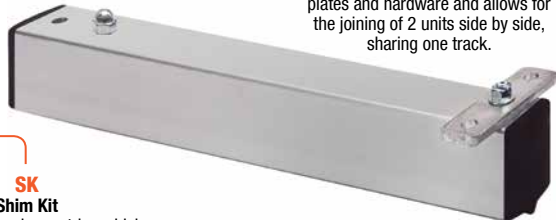

**SK Shim Kit**

48" L thick aluminum strips which can be placed underneath track to help create a level surface for track. (6 per kit)

MODEL NO.	DESCRIPTION	SHIP WGT
<b>Sliding Track Skates</b>		
Also Available with Drift Resistor Add Suffix "DR"		
HD18	One 18" Skate	4 lbs
HD21	One 21" Skate	5 lbs
HD24	One 24" Skate	6 lbs
HD30	One 30" Skate	7 lbs
HD36	One 36" Skate	8 lbs
<b>Additional Components</b>		
QESTP	End Stop Kit	1 lb
QBRK	Foot Activated Brake Kit	1 lb
QVTRK	V-Track (Sold per inch)	1 lb
WK	Wing Kit	2 lbs
SK*	Shim Kit	3 lbs

\*Shim kit comes with (6) 2" x 48" x 1/16" thick aluminum strips which can be placed underneath track to help create a level surface for track

**STEP BY STEP ORDERING INSTRUCTIONS:**

(Note: Shelves and posts to be purchased separately on pgs. 104-105)

- Step 1.** Select desired length (in inches) of track. Use QVTRK to order track. (Note: single units require two tracks and double units will require three tracks)
- Step 2.** Select corresponding skate size from the chart, which will be the same as the depth of shelving unit to be utilized. Two skates required per single unit and three skates required per double unit. (Note: post height should not exceed a 4 to 1 ratio of skate size)
- Step 3.** Purchase one End Stop Kit QESTP per track length. For each double unit being used, a Wing Kit WK is required.

**SINGLE UNIT TRACK SYSTEM**

(Top View)

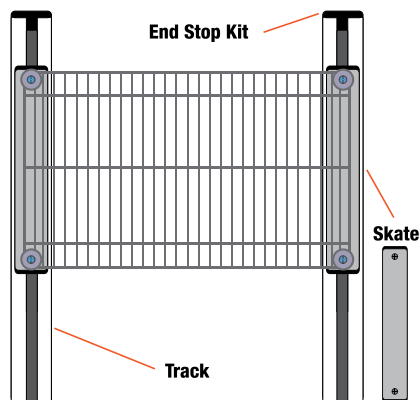

**DOUBLE UNIT TRACK SYSTEM**

(Top View)

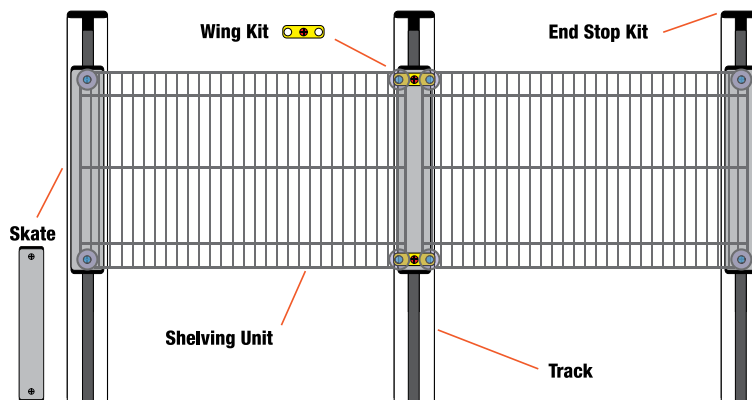

**Single Unit Floor Track Assemblies**



Assembly kit consists of a pair of aluminum tracks with end stop kits. Hardware and assembly instructions included. (Note: custom lengths may be purchased, see pg. 130)

MODEL NO.	TRACK L' (FT)	TRACK L' (IN)	SHIP WGT
<b>Single Unit Floor Track Assembly Kit</b>			
<b>Includes 2 Tracks of Specified Length with End Stop Kits</b>			
QVTRK-2-72EST	6'	72"	14 lbs
QVTRK-2-84EST	7'	84"	16 lbs
QVTRK-2-96EST	8'	96"	18 lbs
QVTRK-2-108EST	9'	108"	20 lbs
QVTRK-2-120EST	10'	120"	22 lbs
QVTRK-2-132EST	11'	132"	24 lbs
QVTRK-2-144EST	12'	144"	26 lbs
QVTRK-2-156EST	13'	156"	28 lbs
QVTRK-2-168EST	14'	168"	30 lbs
QVTRK-2-180EST	15'	180"	32 lbs
QVTRK-2-192EST	16'	192"	34 lbs
QVTRK-2-204EST	17'	204"	36 lbs
QVTRK-2-216EST	18'	216"	38 lbs
QVTRK-2-228EST	19'	228"	40 lbs
QVTRK-2-240EST	20'	240"	42 lbs

**Up to 1,500 lb. SLIDE LOAD CAPACITY PER SHELVING UNIT**

**STEP BY STEP ORDERING INSTRUCTIONS:**

- Select desired length of track and if you require:
  - Single Unit track (use charts on left)
  - Double Unit track (use charts on right)
- Select corresponding skate size from single or double unit charts below. Skate size should match the depth of shelving unit being utilized.
- Using the chart on the bottom of this page, determine how many shelving units will fit on your track.
- Pre-configured 4 and 5 shelf wire units are available on pgs. 106-109. Additional intermediate shelves are available on pg. 104.

**Double Unit Floor Track Assemblies**



Each assembly kit consists of three aluminum tracks with end stop kits. Hardware and assembly instructions included. (Note: custom lengths may be purchased, see pg. 130)

MODEL NO.	TRACK L' (FT)	TRACK L' (IN)	SHIP WGT
<b>Double Unit Floor Track Assembly Kit</b>			
<b>Includes 3 Tracks of Specified Length with End Stop Kits</b>			
QVTRK-3-72EST	6'	72"	21 lbs
QVTRK-3-84EST	7'	84"	24 lbs
QVTRK-3-96EST	8'	96"	27 lbs
QVTRK-3-108EST	9'	108"	30 lbs
QVTRK-3-120EST	10'	120"	33 lbs
QVTRK-3-132EST	11'	132"	36 lbs
QVTRK-3-144EST	12'	144"	39 lbs
QVTRK-3-156EST	13'	156"	42 lbs
QVTRK-3-168EST	14'	168"	45 lbs
QVTRK-3-180EST	15'	180"	48 lbs
QVTRK-3-192EST	16'	192"	51 lbs
QVTRK-3-204EST	17'	204"	54 lbs
QVTRK-3-216EST	18'	216"	57 lbs
QVTRK-3-228EST	19'	228"	60 lbs
QVTRK-3-240EST	20'	240"	63 lbs

**Single Unit Skate Assembly Kits**



Each kit includes two skates and all appropriate hardware. One kit is required for each single mobile unit. (Shelves and posts sold separately on pgs. 104-105)

MODEL NO.	DESCRIPTION	SHIP WGT
<b>Single Unit Skate Assembly Kits</b>		
<b>Also Available with Drift Resistor Add Suffix "DR"</b>		
HD18-2	Two 18" Skates	8 lbs
HD21-2	Two 21" Skates	10 lbs
HD24-2	Two 24" Skates	12 lbs
HD30-2	Two 30" Skates	14 lbs
HD36-2	Two 36" Skates	16 lbs

**Double Unit Skate Assembly Kits**



Each kit includes three skates and all appropriate hardware. One kit is required for each double mobile unit. (Shelves and posts sold separately on pgs. 104-105)

MODEL NO.	DESCRIPTION	SHIP WGT
<b>Double Unit Skate Assembly Kits</b>		
<b>Also Available with Drift Resistor Add Suffix "DR"</b>		
HD18-3	Three 18" Skates + Wing Kit	15 lbs
HD21-3	Three 21" Skates + Wing Kit	18 lbs
HD24-3	Three 24" Skates + Wing Kit	21 lbs
HD30-3	Three 30" Skates + Wing Kit	24 lbs
HD36-3	Three 36" Skates + Wing Kit	27 lbs

**QUANTITY OF SHELVING UNITS BY WIDTH TO FIT ON LENGTH OF TRACK\***

	6'	7'	8'	9'	10'	11'	12'	13'	14'	15'	16'	17'	18'	19'	20'
18"	2	2	3	4	4	5	6	6	7	8	8	9	10	10	11
21"	1	2	2	3	4	4	5	5	6	6	7	8	8	9	9
24"	1	2	2	3	3	4	4	5	5	6	6	7	7	8	8
30"	1	1	2	2	2	3	3	4	4	4	5	5	6	6	6
36"	1	1	1	2	2	2	3	3	3	4	4	4	5	5	5

\*Using a minimum 36" aisle space. Note: Post height should not exceed the skate length by a 4 to 1 ration (example 18" skate should not exceed a 74" post)



**TK-CBW Track Roller**  
Included with Mobile kit  
(4 per kit)

**Sliding Overhead Track System**



**Up to 1,200 lb. LOAD CAPACITY PER UNIT**

Quantum's Overhead Track wire shelving system provides maximum storage using a minimum of space. All kits include all necessary sections of track for assembling lengths that range from 8' to 24' (*note: shelves and posts sold separately*). Assembly is quick and easy and the whole system requires only single-aisle access. Casters are 5" x 1-1/4" rigid thermoplastic resin. Overhead Track design provides a clear walkway and clear aisles underneath eliminating any tripping hazard. Overhead Track extrusion manufactured of heavy-duty aluminum ensuring years of heavy-duty and reliable service.

**PERFORMANCE FEATURES AND BENEFITS:**

- NSF approved
- Uses industrial bearings
- Corrosion free construction
- Easy to roll construction
- Fast installation
- Utilizes the structure of existing shelving
- Up to 1,200 lb. load capacity per unit
- Can increase storage areas up to 150%

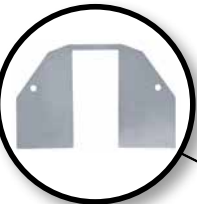

**TK-EP Track End Plate**  
(4 per kit)



**TRACK WITHOUT END PLATE**



**TRACK WITH END PLATE**

**INCREASE STORAGE AREAS UP TO 150%**



MODEL NO.	DESCRIPTION	SHIP WGT
<b>Overhead Track</b>		
TK-2	One Track - 2 Feet	7 lbs
TK-26	One Track - 2-1/2 Feet	9 lbs
TK-5	One Track - 5 Feet	17 lbs
TK-6	One Track - 6 Feet	21 lbs
TK-7	One Track - 7 Feet	24 lbs
TK-EP	Track End Plates with Hardware (Set of 4)	1 lb
TK-CA	Track Connector with Hardware (Set of 4)	6 lbs
<b>End Unit Single Sided Track Bracket Pair</b>		
TK-STB18	18" Single Overhead Track Bracket Pair	4 lbs
TK-STB21	21" Single Overhead Track Bracket Pair	5 lbs
TK-STB24	24" Single Overhead Track Bracket Pair	6 lbs
<b>Intermediate Unit Double Sided Track Bracket Pair</b>		
TK-DTB18	18" Double Overhead Track Bracket Pair	4 lbs
TK-DTB21	21" Double Overhead Track Bracket Pair	5 lbs
TK-DTB24	24" Double Overhead Track Bracket Pair	6 lbs
<b>Mobile Unit Track Rollers</b>		
TK-CBW	Set of 4 Track Rollers	2 lbs



**STATIONARY END KIT**  
(Shelves sold separately)



**INTERMEDIATE KIT**  
(Shelves sold separately)



**MOBILE KIT**  
(Shelves sold separately)

**STEP BY STEP ORDERING INSTRUCTIONS:**

- Step 1.** Select desired length of track.
- Step 2.** Select corresponding stationary end kit and intermediate kits from charts. Size should match the depth of shelving unit being utilized.
- Step 3.** Using the chart on the bottom of this page, determine how many Mobile Kits will fit on your track.
- Step 4.** Wire shelves are available on pg. 104.



**OVERHEAD TRACK KIT WITH END PLATES**

**Overhead Track Kits**

Each kit includes two track of the same length and end plates. Available in heavy-duty aluminum.

MODEL NO.	TRACK LENGTH* (FT)	TRACK LENGTH* (IN)	SHIP WGT
<b>Overhead Track Kit</b>			
TTK-8	8'	96"	53 lbs
TTK-9	9'	108"	60 lbs
TTK-10	10'	120"	67 lbs
TTK-11	11'	132"	73 lbs
TTK-12	12'	144"	80 lbs
TTK-13	13'	156"	87 lbs
TTK-14	14'	168"	93 lbs
TTK-15	15'	180"	100 lbs
TTK-16	16'	192"	107 lbs
TTK-17	17'	204"	113 lbs
TTK-18	18'	216"	120 lbs
TTK-19	19'	228"	127 lbs
TTK-20	20'	240"	133 lbs
TTK-21	21'	252"	140 lbs

**ADD SUFFIX TO END OF EACH CHROME MODEL NO. WHEN SELECTING EPOXY FINISH**

♦ GREEN P ♦ GRAY GY ♦ BLACK BK

Ex. TTK-M18BK

**Stationary End Kits**

Unit consists of:  
8 - 86" Posts\*  
8 - Foot plates  
4 - Single sided overhead track support brackets

**SINGLE SUPPORT BRACKET**



MODEL NO.	DESCRIPTION	SHIP WGT
TTK-E18	18" Stationary End Kits	64 lbs
TTK-E21	21" Stationary End Kits	72 lbs
TTK-E24	24" Stationary End Kits	80 lbs

\*86" posts are available with pre-inserted leveler and bolt by adding an **X** to the Model No. TTK-E18X

**Intermediate Kits**

Unit consists of:  
4 - 86" Posts\*  
4 - Foot plates  
2 - Double sided overhead track support brackets

**DOUBLE SUPPORT BRACKET**



MODEL NO.	DESCRIPTION	SHIP WGT
TTK-C18	18" Intermediate Kits	32 lbs
TTK-C21	21" Intermediate Kits	36 lbs
TTK-C24	24" Intermediate Kits	40 lbs

\*86" posts are available with pre-inserted leveler and bolt by adding an **X** to the Model No. TTK-C18X

**Mobile Kits**

Unit consists of:  
4 - 74" Posts  
4 - Track rollers  
2 - Tie bars

4 - Rigid casters  
4 - Donut bumpers

**MOBILE KITS**



MODEL NO.	DESCRIPTION	SHIP WGT
TTK-M18	18" Mobile Kit	34 lbs
TTK-M21	21" Mobile Kit	36 lbs
TTK-M24	24" Mobile Kit	38 lbs

**QUANTITY OF SHELVING UNITS BY WIDTH TO FIT ON LENGTH OF TRACK\***

	8'	9'	10'	11'	12'	13'	14'	15'	16'	17'	18'	19'	20'	21'
18"	3	3	4	4	5	6	6	7	7	8	9	9	10	10
21"	2	3	3	4	4	5	5	6	6	7	7	8	8	9
24"	2	2	3	3	4	4	5	5	6	6	7	7	8	8

\*Using a minimum 36" aisle space

**Work Station Carts - The ideal work-in-process cart**

The sloped shelves allow for high visibility, productive rotations and gravity feed. **Cart Finish:** Chrome

Each unit consists of:

- 2 - 34" longer back posts
- 2 - 29" shorter front posts
- 1 - flat wire shelf
- 1 - slanted wire shelf
- 4 - 5" swivel thermoplastic resin casters, 2 with brakes
- 4 - donut bumpers



**M1836SL34C**  
Shown with Bins  
(Bins are sold separately)

MOBILE MODEL NO.	SHELF DIMENSIONS W" x L"	NO. OF SHELVES	SHIP WGT
<b>40"H - Work Station Carts</b>			
M1836SL34C	18" x 36"	2	38 lbs
M1848SL34C	18" x 48"	2	48 lbs
M2436SL34C	24" x 36"	2	44 lbs
M2448SL34C	24" x 48"	2	50 lbs



**MWRS-5-92060**



**WRSL6-74-1848-260**

NO. OF BINS	BIN DIMENSIONS L" x W" x H"	NO. OF SHELVES	STATIONARY		MOBILE	
			MODEL NO.	SHIP WGT	MODEL NO.	SHIP WGT
<b>18"W x 36"L x 63"H - Wire Shelving System with 2 Flat Shelves and 3 Slanted Shelves</b> Includes Dividable Grid Containers Available in Blue, Gray, Red and Clear						
12	DG92035 16-1/2" x 10-7/8" x 3-1/2"	5	WRS-5-92035	89 lbs	MWRS-5-92035	100 lbs
12	DG92060 16-1/2" x 10-7/8" x 6"	5	WRS-5-92060	96 lbs	MWRS-5-92060	107 lbs
12	DG92080 16-1/2" x 10-7/8" x 8"	5	WRS-5-92080	107 lbs	MWRS-5-92080	118 lbs
<b>18"W x 36"L x 74"H - Wire Shelving System with 2 Flat Shelves and 5 Slanted Shelves</b> Includes Economy Shelf Bins Available in Blue, Green, Ivory, Red, Yellow, Black and Clear						
48	QSB103 17-7/8" x 4-1/8" x 4"	7	WRS-7-103	118 lbs	MWRS-7-103	129 lbs
30	QSB104 17-7/8" x 6-5/8" x 4"	7	WRS-7-104	110 lbs	MWRS-7-104	121 lbs
24	QSB108 17-7/8" x 8-3/8" x 4"	7	WRS-7-108	113 lbs	MWRS-7-108	124 lbs
18	QSB110 17-7/8" x 11-1/8" x 4"	7	WRS-7-110	111 lbs	MWRS-7-110	122 lbs
<b>18"W x 36"L x 74"H - Wire Shelving System with 2 Flat Shelves and 5 Slanted Shelves</b> Includes Euro Drawers Available in Blue, Red, Yellow and Gray						
48	QED604 17-5/8" x 3-3/4" x 4-5/8"	7	WRS-7-604	144 lbs	MWRS-7-604	155 lbs
30	QED602 17-5/8" x 5-9/16" x 4-5/8"	7	WRS-7-602	126 lbs	MWRS-7-602	137 lbs
18	QED606 17-5/8" x 8-3/8" x 4-5/8"	7	WRS-7-606	132 lbs	MWRS-7-606	143 lbs
<b>18"W x 48"L x 74"H - Wire Shelving System with 2 Flat Shelves and 4 Slanted Shelves</b> Includes Ultra Bins Available in Blue, Green, Ivory, Red, Yellow, Black and Clear						
16	QUS260 18" x 11" x 10"	6	WRSL6-74-1848-260	168 lbs	WRCSL6-74-1848-260	179 lbs
<b>24"W x 48"L x 74"H - Wire Shelving System with 2 Flat Shelves and 4 Slanted Shelves</b> Includes Hulk 24" Containers Available in Blue, Red, Yellow and Clear						
16	QUS953 23-7/8" x 11" x 10"	6	WRSL6-74-2448-953	184 lbs	WRCSL6-74-2448-953	195 lbs

**Slanted Shelf Carts - Stationary and Mobile**

Stationary and Mobile Slanted Shelf units create a unique combination of modular components to enhance supply distribution applications. The sloped shelves allow for high visibility, productive rotations and gravity feed. **(Note: Build a system with your bin requirements or consult a product specialist for appropriate components)**

Each unit consists of:

- 4 - 63" posts
- 2 - flat wire shelves
- 3 - slanted wire shelves

Each mobile unit consists of:

- 4 - 63" posts
- 2 - flat wire shelves
- 3 - slanted wire shelves
- 4 - 5" swivel thermoplastic resin casters, 2 with brakes
- 4 - donut bumpers

**63"H - SLANTED SHELF CARTS**

SHELF DIMENSIONS W" x L"	NO. OF SHELVES	STATIONARY		MOBILE	
		MODEL NO.	SHIP WGT	MODEL NO.	SHIP WGT
18" x 36"	5	1836SL6C	66 lbs	M1836SL6C	76 lbs
18" x 48"	5	1848SL6C	86 lbs	M1848SL6C	96 lbs
24" x 36"	5	2436SL6C	81 lbs	M2436SL6C	91 lbs
24" x 48"	5	2448SL6C	96 lbs	M2448SL6C	106 lbs

**COMPLETE PACKAGES WITH BINS**



**MWRS-7-104**

**Up to 1,200 lb. MOBILE LOAD CAPACITY**

**Slanted Shelf with Bin Holders Combo Carts**

A systems cart that offers hanging bins, slanted bins and bins on a flat surface all in one unit. Carts offer the ability to store pre-packed items or sloped storage for dispensing small parts. This combination creates a highly customized exchange and storage system. **Cart Finish:** Chrome

Bins available in: ● Blue ● Green ● Ivory ● Red ● Yellow  
● Black ● Clear (One color per unit)

MODEL NO.	NO. OF SHELVES	NO. OF BINS	BIN DIMENSIONS L" x W" x H"	SHIP WGT
<b>18"W x 36"L x 80"H - Slanted Wire Shelf Cart with Bin Holders and Bins</b>				
WRCSL5-74-1836-104220	5	20 QSB104 24 QUS220	17-7/8" x 6-5/8" x 4" 7-3/8" x 4-1/8" x 3"	105 lbs
WRCSL5-74-1836-104230	5	20 QSB104 18 QUS230	17-7/8" x 6-5/8" x 4" 10-7/8" x 5-1/2" x 5"	112 lbs
<b>18"W x 48"L x 80"H - Slanted Wire Shelf Cart with Bin Holders and Bins</b>				
WRCSL5-74-1848-104220	5	24 QSB104 30 QUS220	17-7/8" x 6-5/8" x 4" 7-3/8" x 4-1/8" x 3"	128 lbs

**Slanted Shelf Carts - Open or Enclosed**

Units are designed for quick and easy accessibility for pre-packed items. The wire end panel maintains product while the slanted shelf allows for gravity feed. Available with or without side enclosures. **Cart Finish:** Chrome

OPEN		ENCLOSED	
MODEL NO.	SHIP WGT	MODEL NO.	SHIP WGT
<b>5 Shelf - Slanted Cart 2 Flat Shelves and 3 Slanted Shelves</b>			
WRCSL5-63-1836	76 lbs	WRCSL5-63-1836EP	88 lbs
WRCSL5-63-1848	96 lbs	WRCSL5-63-1848EP	108 lbs
WRCSL5-63-2436	91 lbs	WRCSL5-63-2436EP	105 lbs
WRCSL5-63-2448	106 lbs	WRCSL5-63-2448EP	120 lbs

**COMPLETE  
PACKAGES  
WITH BINS**



WRCSL5-74-1836-104230



WRCSL5-63-1836EP

**QUANTUM  
HAS A NEW ANGLE  
FOR STORAGE**



WRCSL5-63-1836-104

**Up to 1,200 lb.  
MOBILE LOAD  
CAPACITY**

**Dividers, Bin Cups and  
Clear Label Holders**  
See pg. 50

Bins available in: ● Blue ● Green ● Ivory ● Red ● Yellow ● Black ● Clear (One color per unit)

		OPEN		ENCLOSED	
NO. OF BINS	BIN DIMENSIONS L" x W" x H"	MODEL NO.	SHIP WGT	MODEL NO.	SHIP WGT
<b>5 Shelf - Slanted Shelf Cart with Bins 2 Flat Shelves and 3 Slanted Shelves</b>					
20 QSB104	17-7/8" x 6-5/8" x 4"	WRCSL5-63-1836-104	94 lbs	WRCSL5-63-1836EP-104	103 lbs
28 QSB104	17-7/8" x 6-5/8" x 4"	WRCSL5-63-1848-104	114 lbs	WRCSL5-63-1848EP-104	123 lbs
20 QSB106	23-5/8" x 6-5/8" x 4"	WRCSL5-63-2436-106	115 lbs	WRCSL5-63-2436EP-106	131 lbs
28 QSB106	23-5/8" x 6-5/8" x 4"	WRCSL5-63-2448-106	136 lbs	WRCSL5-63-2448EP-106	152 lbs

**Bin Cart Systems**

Bin carts can be used for transporting and holding product. A modular drawer system allows for storage of smaller specialty components while the open shelf design maximizes the storage area. The option of cart covers *pg. 124*, enclosure panels *pg. 164*, ledges and dividers *pg. 165* add to the flexibility of the unit. **Cart Finish:** Chrome

Bins available in: ● Blue ● Red ● Gray ● Clear (One color per unit)

MODEL NO.	NO. OF BINS	BIN DIMENSIONS L" x W" x H"	SHIP WGT
<b>24"W x 36"L x 69"H - Bin Cart with Dividable Grids</b>			
WRC5-63-2436-93060	4 DG93060	22-1/2" x 17-1/2" x 6"	113 lbs
<b>24"W x 48"L x 69"H - Bin Cart with Dividable Grids</b>			
WRC5-63-2448-93060	4 DG93060	22-1/2" x 17-1/2" x 6"	128 lbs
<b>24"W x 60"L x 69"H - Bin Cart with Dividable Grids</b>			
WRC5-63-2460-93060	4 DG93060	22-1/2" x 17-1/2" x 6"	153 lbs

**COMPLETE PACKAGES WITH BINS**



**WRC5-63-2436-93060**

- Each unit consists of:
- 4 - 63" posts
  - 5 - wire shelves
  - 4 - DS18-24 bin slides
  - 4 - 5" swivel thermoplastic resin casters, 2 with brake
  - 4 - donut bumpers
  - 4 - DG93060 bins (Blue, Red, Gray or Clear)



**ALL MOBILE UNITS INCLUDE FOUR 5" x 1-1/4" SWIVEL CASTERS, 2 WITH BRAKES**

**Up to 1,200 lb. MOBILE LOAD CAPACITY**



**DIVIDERS**

Containers can be divided by length and/or width allowing a subdivision down to a 1-1/8" square compartment size. See *pg. 69*

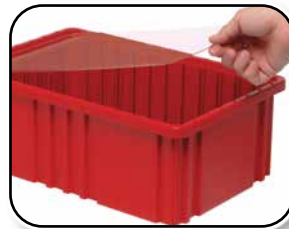

**CLEAR ACRYLIC INLAYS**

Keep stored items visible while protecting against airborne dust and other contaminants. Cover lays inside on rim of container. See *pg. 69*

**Bin Carts**

Offering two heights and four bin quantity designs, these modular carts are the ultimate work-in-process and transport carts. Dividable grids slide easily in and out and with their ability to be divided into multiple compartments with long and short dividers, truly any type of storage is possible, see *pg. 69* for dividers and label holders. **Cart Finish:** Chrome

Bins available in: ● Blue ● Red ● Gray ● Clear (One color per unit)

MODEL NO.	NO. OF BINS	BIN DIMENSIONS L" x W" x H"	SHIP WGT
<b>21"W x 24"L x 45"H - Bin Cart with Dividable Grid Containers</b>			
BC212434M1	4 DG93060	22-1/2" x 17-1/2" x 6"	58 lbs
BC212439M2	7 DG93030	22-1/2" x 17-1/2" x 3"	79 lbs
<b>21"W x 24"L x 69"H - Bin Cart with Dividable Grid Containers</b>			
BC212469M1	7 DG93060	22-1/2" x 17-1/2" x 6"	107 lbs
BC212469M2	11 DG93030	22-1/2" x 17-1/2" x 3"	111 lbs
<b>21"W x 24"L x 45"H - Bin Cart with No Dividable Grid Containers</b>			
BC212439M4	No Containers (includes slides for 4 bin levels)		46 lbs
BC212439M7	No Containers (includes slides for 7 bin levels)		55 lbs
<b>21"W x 24"L x 69"H - Bin Cart with No Dividable Grid Containers</b>			
BC212469M	No Containers (includes slides for 7 bin levels)		63 lbs
BC212469M11	No Containers (includes slides for 11 bin levels)		75 lbs
WR-S24W	-	-	3 lbs



BC212434M1



BC212469M1

CLEAR BINS AVAILABLE VIEW



BC214069M1D



BC216069M2T

### Double & Triple Bay Bin Carts

Offering double or triple bays and four bin quantity designs, these modular carts are the ultimate work-in-process and transport carts. Dividable grids slide easily in and out and with their ability to be divided into multiple compartments with long and short dividers, truly any type of storage is possible, see **pg. 69** for dividers and label holders. Bins can be covered by using our clear acrylic inlays, see below. **Cart Finish:** Chrome

Up to **1,200 lb.** MOBILE LOAD CAPACITY

### Double Bay Bin Carts

Bins available in: ● Blue ● Red ● Gray ● Clear (One color per unit)

MODEL NO.	NO. OF BINS	BIN DIMENSIONS L" x W" x H"	SHIP WGT
<b>24"W x 40"L x 69"H - Bin Cart with Dividable Grid Containers</b>			
BC214069M1D	14 DG93060	22-1/2" x 17-1/2" x 6"	163 lbs
BC214069M2D	22 DG93030	22-1/2" x 17-1/2" x 3"	164 lbs
<b>24"W x 40"L x 69"H - Bin Cart with No Dividable Grid Containers</b>			
BC214069M14D	No Containers (includes slides for 14 bin levels)	-	75 lbs
BC214069M22D	No Containers (includes slides for 22 bin levels)	-	91 lbs
<b>One Pair - 24" Wire Single Bin Slides</b>			
WR-S24W	-	-	3 lbs
<b>One - 24" Wire Double Bin Slide</b>			
WR-D24W	-	-	2 lbs

## COMPLETE PACKAGES WITH BINS



#### DIVIDERS

Containers can be divided by length and/or width allowing a subdivision down to a 1-1/8" square compartment size. See **pg. 69**



#### CLEAR ACRYLIC INLAYS

Keep stored items visible while protecting against airborne dust and other contaminants. Cover lays inside on rim of container. See **pg. 69**

Up to **1,200 lb.** MOBILE LOAD CAPACITY

### Triple Bay Bin Carts

Bins available in: ● Blue ● Red ● Gray ● Clear (One color per unit)

MODEL NO.	NO. OF BINS	BIN DIMENSIONS L" x W" x H"	SHIP WGT
<b>24"W x 60"L x 69"H - Bin Cart with Dividable Grid Containers</b>			
BC216069M1T	21 DG93060	22-1/2" x 17-1/2" x 6"	233 lbs
BC216069M2T	33 DG93030	22-1/2" x 17-1/2" x 3"	234 lbs
<b>24"W x 60"L x 69"H - Bin Cart with No Dividable Grid Containers</b>			
BC216069M21T	No Containers (includes slides for 21 bin levels)	-	100 lbs
BC216069M33T	No Containers (includes slides for 33 bin levels)	-	124 lbs
<b>One Pair - 24" Wire Single Bin Slides</b>			
WR-S24W	-	-	3 lbs
<b>One - 24" Wire Double Bin Slide</b>			
WR-D24W	-	-	2 lbs

**Modular Wire Stacking Baskets**

Offer a variety of storage, display, and mobile supply applications. Dividers can be used to separate product. Accessible front and a wide selection of sizes allow for all types of product to be used from storage to display. (Dividers sold separately) **Finish:** Chrome



**1436BC**  
Shown with Dividers and Clear Label Holder (Sold separately)

**CLEAR LABEL HOLDERS**  
Super easy method for identifying product. Affix directly to the front on any basket. Available in three lengths. (Sold separately)

MODEL NO.	DESCRIPTION	SHIP WGT
<b>Clear Label Holders</b>		
<b>BLH3C</b>	3" Clear Label Holder	1 lb
<b>BLH14C</b>	14" Clear Label Holder	1 lb
<b>BLH32C</b>	32" Clear Label Holder	1 lb

MODEL NO.	BASKET DIMENSIONS W" x L" x H"	SHIP WGT	DIVIDER MODEL NO.	SHIP WGT
<b>1436BC</b>	14" x 36" x 9"	10 lbs	<b>149DC</b>	1 lb
<b>1448BC</b>	14" x 48" x 9"	13 lbs	<b>149DC</b>	1 lb
<b>2036BC</b>	20" x 36" x 9"	12 lbs	<b>209DC</b>	2 lbs
<b>2048BC</b>	20" x 48" x 9"	15 lbs	<b>209DC</b>	2 lbs
<b>203612BC</b>	20" x 36" x 12"	14 lbs	<b>2012DC</b>	2 lbs
<b>204812BC</b>	20" x 48" x 12"	16 lbs	<b>2012DC</b>	2 lbs

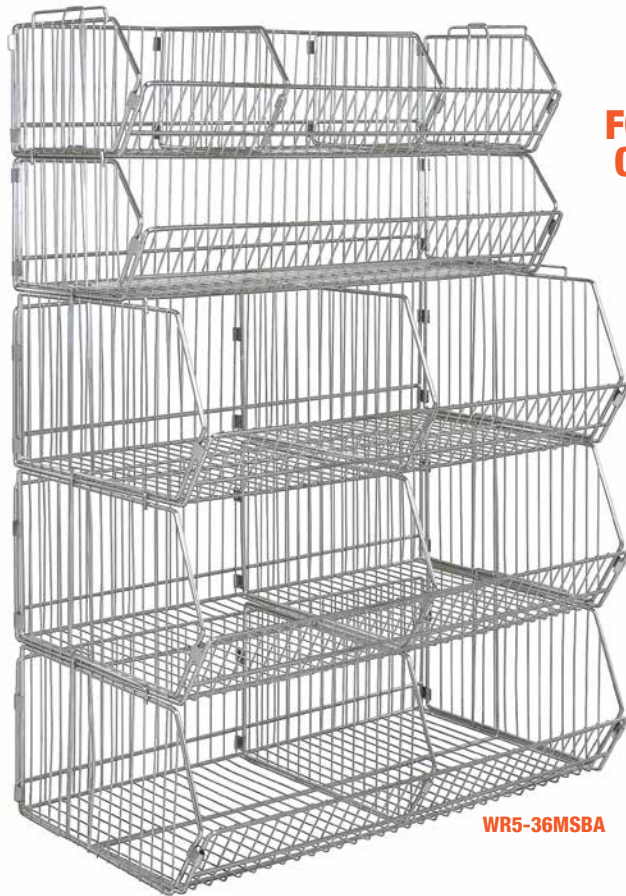

**WR5-36MSBA**

**FOR ALL TYPES OF PRODUCTS**



**DOLLY BASE**

**WR5-36MSBA-MOB**

**Up to 80 lb. STACK CAPACITY PER BASKET**

Build and stack any combination of baskets for your requirements. Larger baskets must be positioned on the lowest point.

**Up to 800 lb. MOBILE LOAD CAPACITY**

**Stationary Stacking Baskets**

- Order this exact unit  
**WR5-36MSBA**  
Unit consists of:
- 2 - baskets **1436BC**
  - 2 - dividers **149DC**
  - 3 - baskets **203612BC**
  - 3 - dividers **2012DC**

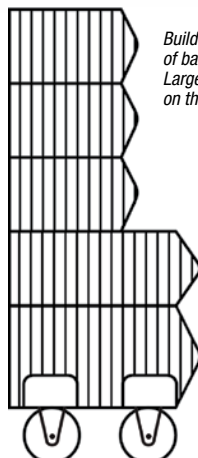

**Dolly Base**

Includes 4 - 5" x 1-1/4" swivel casters which offer easy transport.

MODEL NO.	DIMENSIONS W" x L"	SHIP WGT
<b>M2036BD</b>	20" x 36"	32 lbs
<b>M2048BD</b>	20" x 48"	34 lbs

**Mobile Stacking Baskets**

- Order this exact unit  
**WR5-36MSBA-MOB**  
Unit consists of:
- 2 - baskets **1436BC**
  - 2 - dividers **149DC**
  - 3 - baskets **203612BC**
  - 3 - dividers **2012DC**
  - 1 - dolly **M2036BD**

### 3 BASKET POSITIONS FOR FLEXIBLE STORAGE



**ANGLE DOWN**  
Flows parts to front  
provides maximum  
accessibility



**FLAT**  
Provides maximum  
space efficiency



**ANGLED UP**  
Provides maximum  
bin capacity

### Wire Basket Units

Basket units allow high visibility and air circulation. Baskets act as perfect pick bins which can be added to 18", 21" and 24" deep shelving units. The collar hook allows the basket to be removed or adjusted to accommodate various product mix and sizes. Baskets are adjustable on 1" increments. Up to 150 lb. load capacity per basket. Adjustable baskets used in combination with shelves are an excellent method to store all types of products. Units can be stationary or mobile. Casters add flexibility and convert stationary units into transport systems. Ideal for exchange charts and par level storage. *(Dividers sold separately)* **Finish:** Chrome

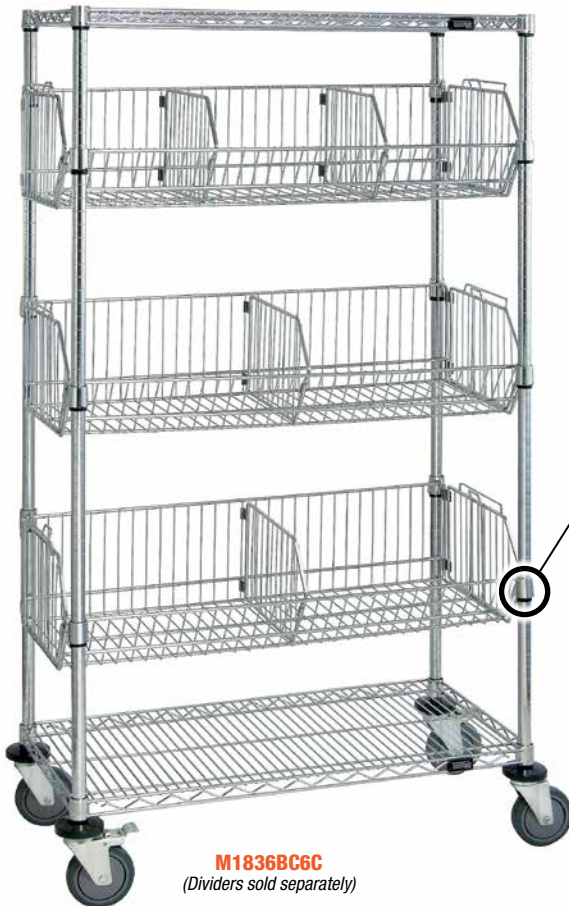

**M1836BC6C**  
*(Dividers sold separately)*



**COLLAR HOOKS**  
Hooks onto basket corner  
allowing basket to securely hang.



**1836BC6C**  
*(Dividers sold separately)*

### Mobile Wire Basket Units

Each mobile unit consists of:

- 4 - 63"H posts
- 3 - 9"H adjustable baskets including collar hooks
- 2 - wire shelves
- 4 - donut bumpers
- 4 - swivel 5" x 1-1/4" thermoplastic resin casters, 2 with brakes

MOBILE MODEL NO.	DIMENSIONS W" x L" x H"	NO. OF SHELVES	NO. OF BASKETS	SHIP WGT
<b>M1836BC6C</b>	18" x 36" x 69"	2	3	78 lbs
<b>M1848BC6C</b>	18" x 48" x 69"	2	3	90 lbs
<b>M2436BC6C</b>	24" x 36" x 69"	2	3	93 lbs
<b>M2448BC6C</b>	24" x 48" x 69"	2	3	108 lbs

## COMPLETE PACKAGES WITH BASKETS

### Stationary Wire Basket Units

Each stationary unit consists of:

- 4 - 63"H posts
- 3 - 9"H adjustable baskets including collar hooks
- 2 - wire shelves

STATIONARY MODEL NO.	DIMENSIONS W" x L" x H"	NO. OF SHELVES	NO. OF BASKETS	SHIP WGT
<b>1836BC6C</b>	18" x 36" x 63"	2	3	70 lbs
<b>1848BC6C</b>	18" x 48" x 63"	2	3	82 lbs
<b>2436BC6C</b>	24" x 36" x 63"	2	3	85 lbs
<b>2448BC6C</b>	24" x 48" x 63"	2	3	100 lbs

Post Baskets

HIGH VISIBILITY, EASY TO CLEAN, ALL-WELDED

Quantum's post baskets are manufactured of industrial grade chrome wire offering a 5/8" x 5/8" mesh design on the bottom/flat surface. Super heavy-duty design affords a generous up to 600-800 lb. load capacity\* evenly distributed. Unique design allows baskets to be used without needing any flat shelves to stabilize overall unit. Drop front and sloped sides provide super easy access while providing a captive space for stored items. Baskets are all adjustable on 1" increments utilizing standard 1" diameter posts. *Finish: Chrome*



MODEL NO.	DIMENSIONS W" x L" x H"	SHIP WGT	DIVIDER MODEL NO.	SHIP WGT
BSK1824C	18" x 24" x 10"	11 lbs	DSK18	2 lbs
BSK1836C	18" x 36" x 10"	13 lbs	DSK18	2 lbs
BSK1848C	18" x 48" x 10"	17 lbs	DSK18	2 lbs
BSK1860C	18" x 60" x 10"	27 lbs	DSK18	2 lbs
BSK2424C	24" x 24" x 10"	12 lbs	DSK24	3 lbs
BSK2436C	24" x 36" x 10"	15 lbs	DSK24	3 lbs
BSK2448C	24" x 48" x 10"	20 lbs	DSK24	3 lbs
BSK2460C	24" x 60" x 10"	34 lbs	DSK24	3 lbs

\*24" - 48" wide offer up to 800 lb. capacity evenly distributed 60" wide offers up to 600 lb. capacity evenly distributed

**BSK1836C**  
Basket shown with Blue Hanging Label Tag PS-LH3  
Available in:  
● Clear ● Red ● Yellow ● Blue ● Green  
● Orange ● Purple  
(Sold separately)

Clear Label Holders

A super easy method for identifying product. Affixes directly to the front on any post basket. Available in six lengths. (Label inserts sold separately)

MODEL NO.	DESCRIPTION	SHIP WGT
<b>Clear Label Holders</b>		
BLH3C	3" Clear Label Holder	1 lb
BLH14C	14" Clear Label Holder	1 lb
BLH20C	20" Clear Label Holder	1 lb
BLH32C	32" Clear Label Holder	1 lb
BLH44C	44" Clear Label Holder	1 lb
BLH56C	56" Clear Label Holder	1 lb

COMPLETE CARTS INCLUDE CASTER KIT FOR MOBILITY

Up to 1,200 lb. MOBILE LOAD CAPACITY

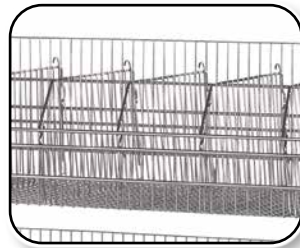

DIVIDERS

Post basket divider allows you to quickly and easily organize the contents of your post basket unit by creating separate compartments within each basket (Sold separately)

Mobile 5 Post Basket Units

Each mobile unit consists of:

- 4 - 74" H posts
- 5 - post basket
- 4 - donut bumpers
- 4 - 5" x 1-1/4" swivel thermoplastic resin casters, 2 with brake

MODEL NO.	DIMENSIONS W" x L" x H"	SHIP WGT
WRC74-BSK1824C-5	18" x 24" x 80"	94 lbs
WRC74-BSK1836C-5	18" x 36" x 80"	127 lbs
WRC74-BSK1848C-5	18" x 48" x 80"	160 lbs
WRC74-BSK1860C-5	18" x 60" x 80"	197 lbs
WRC74-BSK2424C-5	24" x 24" x 80"	125 lbs
WRC74-BSK2436C-5	24" x 36" x 80"	158 lbs
WRC74-BSK2448C-5	24" x 48" x 80"	191 lbs
WRC74-BSK2460C-5	24" x 60" x 80"	228 lbs



WRC74-BSK1836C-5

## Hanging Label Tags

# 7 COLORS AVAILABLE

New design Hanging Label tab has flat surface on one side to allow for self-adhesive label. Opposite side has a slot for label to be inserted and easily removed or changed as needed. Paper labels are not included. Label tags work with all wire shelves, mesh bins, hanging, stacking and post baskets. Available in 7 colors. Package of 25.

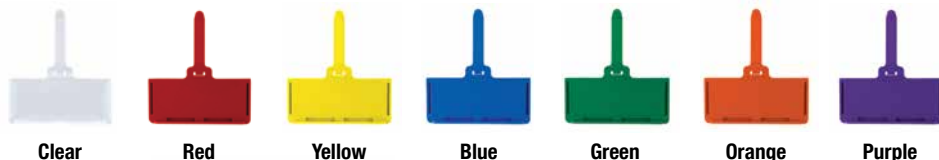

**PS-LH3**

**Hanging Label Tag**

Fits 1-3/8" x 3" Adhesive Label or Slide in Label

## Shelf Label Holders

Are an excellent method for identifying product. Holders affix directly to snake frame front on any size shelf. (Label inserts sold separately)

**LHA3C**



## EASILY IDENTIFY PRODUCT ON ANY SIZE SHELF



**LH3C and LH3B Front Shelf View**



**LHA3C 3 Different Angles**

## ANGLED LABEL HOLDER ADVANTAGE

**ANGLED LABEL HOLDERS ALLOW YOU TO POSITION AND PIVOT ANGLE TO BEST SUIT YOUR NEEDS ANGLE UP OR DOWN WITH EASE**

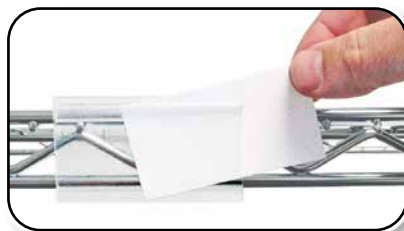

Inserts slide into label holders easily



Clear Label Holder

## Stacking & Post Basket Clear Label Holders

A super easy method for identifying product. Affixes directly to the front on any stacking and post basket. Available in six lengths. (Label inserts sold separately)

MODEL NO.	DESCRIPTION	SHIP WGT
<b>Clear Label Holders</b>		
<b>BLH3C</b>	3" Clear Label Holder	1 lb
<b>BLH14C</b>	14" Clear Label Holder Fits 18" Wide Basket	1 lb
<b>BLH20C</b>	20" Clear Label Holder Fits 24" Wide Basket	1 lb
<b>BLH32C</b>	32" Clear Label Holder Fits 36" Wide Basket	1 lb
<b>BLH44C</b>	44" Clear Label Holder Fits 48" Wide Basket	1 lb
<b>BLH56C</b>	56" Clear Label Holder Fits 60" Wide Basket	1 lb



**BLH20C**

Shown on Basket with Dividers (Sold separately)

## Laser and Inkjet Label Inserts

Laser and inkjet compatible inserts come in 8-1/2" x 11" perforated sheets. Available in 3" and 6" lengths. Multiple inserts can be used on longer label holders. Package of 48 labels.

MODEL NO.	DESCRIPTION	SHIP WGT
<b>Laser and Inkjet Label Inserts - 48 Labels</b>		
<b>LHI-3</b>	1-1/4" x 3" Inserts (3 Sheets)	1 lb
<b>LHI-6</b>	1-1/4" x 6" Inserts (6 Sheets)	1 lb

## NEED A LARGER SURFACE AREA FOR IDENTIFICATION?

New generation extended clear label holder clips onto the front snake frame of any wire shelf and offers a 3"H x 5"W label slot with paper insert. Labels can be changed or easily relocated. Laser and inkjet compatible inserts come in 8-1/2" x 11" perforated sheets. Package of 12.



**LHE3X5C**

## Hanging Basket Clear Label Holders

A super easy method for identifying product. Affixes directly to the front on any hanging basket. Available in four lengths. (Label inserts sold separately)

MODEL NO.	DESCRIPTION	SHIP WGT
<b>Clear Label Holders</b>		
<b>HBL3C</b>	3" Clear Label Holder	1 lb
<b>HBL165C</b>	16-1/2" Clear Label Holder Fits 18" Wide Basket	1 lb
<b>HBL345C</b>	34-1/2" Clear Label Holder Fits 36" Wide Basket	1 lb
<b>HBL465C</b>	46-1/2" Clear Label Holder Fits 48" Wide Basket	1 lb

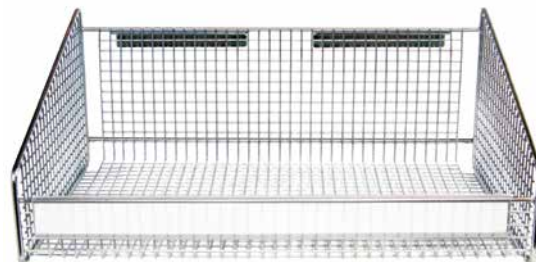

**HBL165C**

PARTition Wall Systems

INSTANT VISIBILITY, EASY TO CLEAN, ALL WELDED

**1017HBC Basket**  
11-7/8"W x 18"L x 7-1/2"H

**HBL165C 16-1/2" Clear Label Holder**  
also available in 3" and 34-1/2"

**Stackable Shelf Bins**  
available on *pg. 34*

**QLP-3661HC Louvered Panel**  
36"L x 61"H  
used with mounting frame  
**WS-PM36HC**

**1035HBC Basket**  
11-7/8"W x 36"L x 7-1/2"H

**1606DHB Divider**      74" H

**1617HBC Basket**  
17-7/8"W x 18"L x 7-1/2"H

**WS-1818DSHC Dust Shelf**  
18"W x 18"L

**26" D**

**WS70-SS18ADHC 18" PARTITION Wall System**  
shown with Mobile Kit and optional accessories

**WS70-SS36HC 36" PARTITION Wall System**  
shown with Mobile Kit and optional accessories

**54" W**

**QTB-LP-BKT Tip Out Bin Hanging Bracket**  
available on *pg. 91*

**Tip Out Bins**  
available on *pg. 91*

**Mesh Stack & Hang Bins**  
available on *pg. 6*

**1006DHB Divider**

**HBL345C 34-1/2" Clear Label Holder**  
also available in 3" and 16-1/2"

**Ultra Stack & Hang Bins**  
available on *pg. 5*  
**Clear Stack & Hang Bins**  
available on *pg. 21 & 22*

**1635HBC Basket**  
17-7/8"W x 36"L x 7-1/2"H

**WS-1836DSHC Dust Shelf**  
18"W x 36"L



**QTB-LP-BKT**  
Hanging Bracket for Tip Out Bins  
(Available in Beige or Gray)



All Starter and Add-On Units  
come standard with Leg Levelers



All Starter and Add-On Units  
can be made mobile

Mobilize your units by ordering the following:

**Single Sided Starter Kit**

- 2 - **WS-SSMOB** Bar
- 2 - **WS-MOB** Caster Kit

**Double Sided Starter Kit**

- 2 - **WS-DSMOB** Bar
- 2 - **WS-MOB** Caster Kit

**Single Sided Add-On Kit**

- 1 - **WS-SSMOB** Bar
- 1 - **WS-MOB** Caster Kit

**Double Sided Add-On Kit**

- 1 - **WS-DSMOB** Bar
- 1 - **WS-MOB** Caster Kit

**FIRST POSITION**  
Flat, straight



**SECOND POSITION**  
10° down slope



**THIRD POSITION**  
30° down slope



**ADJUSTABLE BRACKETS  
ALLOW YOU TO CHOOSE  
YOUR IDEAL POSITION  
AND EASIEST ACCESS  
TO STORED PRODUCT**

**COMPLETE  
PACKAGES  
WITH BASKETS**

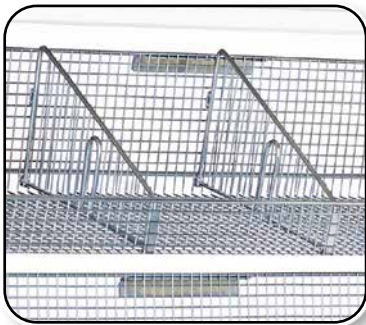

**DIVIDERS**

Basket pressure fit divider allows you to quickly and easily organize the contents of your basket unit by creating separate compartments within each basket  
*(Sold separately)*



**WS70-SS36-4S3L**  
Shown with dividers  
*(Sold separately)*

**PARTition Wall Systems - Complete Packages**

PARTition Wall Hanging Baskets are uniquely designed for instant visibility and easy access while maximizing your storage area. The wire construction minimizes dirt accumulation and allows air circulation. Baskets have a 1/2" x 1/2" grid pattern to partition product while letting you know when to reorder product and restock items. Available in 11-7/8" and 17-7/8" widths, and in 18", 36", and 48" lengths. **Finish:** Chrome

STARTER UNITS		ADD-ON		BASKET		ACCESSORIES		
MODEL NO.	SHIP WGT	MODEL NO.	SHIP WGT	MODEL NO.	NO. OF BASKET	DIVIDER	LABEL HOLDERS	DUST SHELF
MODEL NO.	SHIP WGT	MODEL NO.	SHIP WGT	MODEL NO.	NO. OF BASKET	MODEL NO.	MODEL NO.	MODEL NO.
<b>18" - Single Sided Systems - Complete with Baskets</b>								
WS70-SS18-7S	83 lbs	WS70-SS18AD-7S	71 lbs	1017HBC	7	1006DHB/1006DHB-SQ	HBL165C	WS-1218DSHC
WS70-SS18-4S3L	86 lbs	WS70-SS18AD-4S3L	86 lbs	1017HBC	4	1006DHB/1006DHB-SQ	HBL165C	WS-1818DSHC
				1617HBC	3	1606DHB/1606DHB-SQ	HBL165C	
<b>36" - Single Sided Systems - Complete with Baskets</b>								
WS70-SS36-7S	117 lbs	WS70-SS36AD-7S	105 lbs	1035HBC	7	1006DHB/1006DHB-SQ	HBL345C	WS-1236DSHC
WS70-SS36-4S3L	123 lbs	WS70-SS36AD-4S3L	111 lbs	1035HBC	4	1006DHB/1006DHB-SQ	HBL345C	WS-1836DSHC
				1635HBC	3	1606DHB/1606DHB-SQ	HBL345C	
<b>48" - Single Sided Systems - Complete with Baskets</b>								
WS70-SS48-7S	131 lbs	WS70-SS48AD-7S	119 lbs	1047HBC	7	1006DHB/1006DHB-SQ	HBL465C	WS-1248DSHC
WS70-SS48-4S3L	140 lbs	WS70-SS48AD-4S3L	128 lbs	1047HBC	4	1006DHB/1006DHB-SQ	HBL465C	WS-1848DSHC
				1647HBC	3	1606DHB/1606DHB-SQ	HBL465C	

**Starter Units**

Starter units come complete with two uprights and three tie-bars.



WS70-SS18HC

WS70-SS36HC

WS70-SS48HC

**Add-On Units**

Add-On units allow you to expand your Starter unit by sharing an upright. Add-On unit includes one common upright and three tie-bars.

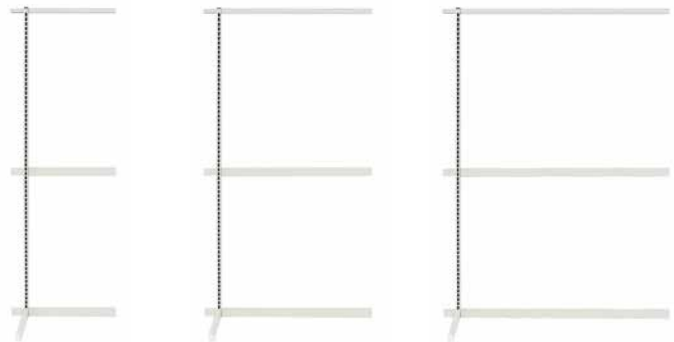

WS70-SS18ADHC

WS70-SS36ADHC

WS70-SS48ADHC

L"	STARTER UNITS		ADD-ON UNITS		ACCESSORIES				
	MODEL NO.	SHIP WGT	MODEL NO.	SHIP WGT	HANG BAR	12" DUST SHELF	18" DUST SHELF	LOUVERED PANEL	PANEL FRAME*
	MODEL NO.	SHIP WGT	MODEL NO.	SHIP WGT	MODEL NO.	MODEL NO.	MODEL NO.	MODEL NO.	MODEL NO.
<b>Single Sided Units</b>									
18"	WS70-SS18HC	31 lbs	WS70-SS18ADHC	31 lbs	-	WS-1218DSHC	WS-1818DSHC	QLP-1861HC	WS-PM18HC
36"	WS70-SS36HC	37 lbs	WS70-SS36ADHC	25 lbs	WS-HB36HC	WS-1236DSHC	WS-1836DSHC	QLP-3661HC	WS-PM36HC
48"	WS70-SS48HC	42 lbs	WS70-SS48ADHC	30 lbs	WS-HB48HC	WS-1248DSHC	WS-1848DSHC	QLP-4861HC	WS-PM48HC
<b>Double Sided Units</b>									
18"	WS70-DS18HC	34 lbs	WS70-DS18ADHC	21 lbs	-	WS-1218DSHC	WS-1818DSHC	QLP-1861HC	WS-PM18HC
36"	WS70-DS36HC	40 lbs	WS70-DS36ADHC	27 lbs	WS-HB36HC	WS-1236DSHC	WS-1836DSHC	QLP-3661HC	WS-PM36HC
48"	WS70-DS48HC	45 lbs	WS70-DS48ADHC	32 lbs	WS-HB48HC	WS-1248DSHC	WS-1848DSHC	QLP-4861HC	WS-PM48HC

\*Required to mount louvered panels

**CUSTOMIZE YOUR OWN UNIT**

For Units using Hanging Brackets:

- Determine total space you want to fill from left to right
- Select a Starter Unit (either 18", 36" or 48" wide)
- Fill remaining space by utilizing Add-On Units
- Determine how many basket levels you want to have per unit, which will correspond to the total number of brackets needed
- Dividers and label holders are available for all basket sizes

For Units using Louvered Panels:

- Determine total space you want to fill from left to right
- Select a Starter Unit (either 18", 36" or 48" wide)
- Fill remaining space by utilizing Add-On Units
- Each unit (both Starter or Add-On) will fit a corresponding 18", 36" or 48" louvered panel (note: Louvered panel requires one panel frame)
- Louvered panel will accommodate:
  - Hanging Baskets** - available on pg. 144
  - Clear Tip Out Bins** - available on pg. 91 (note: one hanging bracket pair QTB-LP-BKT is needed per Tip Out Bin)
  - Mesh Bins** - available on pg. 6
  - Plastic Bins** - available on pgs. 5, 22 and 34 (see chart on the bottom of pg. 9 to determine quantity of bins that fit on panel)

**Hanging Baskets**

- Up to 125 lb. load capacity per basket (up to twice as strong as plastic bins)
- Mesh design ensures no accumulation of dirt or dust and instant visibility
- Brilliant chrome finish ensures professional appearance and years of heavy-duty service
- Baskets can be divided allowing maximization of all space

**UNIQUELY DESIGNED FOR HIGH VISIBILITY AND EASY ACCESS**

MODEL NO.	OUTSIDE DIMENSIONS W" x L" x H"	INSIDE DIMENSIONS W" x L" x H"	SHIP WGT
<b>Hanging Baskets</b>			
1017HBC	11-7/8" x 18" x 7-1/2"	11" x 17-3/8" x 7"	5 lbs
1035HBC	11-7/8" x 36" x 7-1/2"	11" x 35" x 7"	9 lbs
1047HBC	11-7/8" x 48" x 7-1/2"	11" x 47" x 7"	11 lbs
1617HBC	17-7/8" x 18" x 7-1/2"	17" x 17-3/8" x 7"	6 lbs
1635HBC	17-7/8" x 36" x 7-1/2"	17" x 35" x 7"	11 lbs
1647HBC	17-7/8" x 48" x 7-1/2"	17" x 47" x 7"	14 lbs



WS-DS36HC  
Shown with Baskets  
(Sold separately)

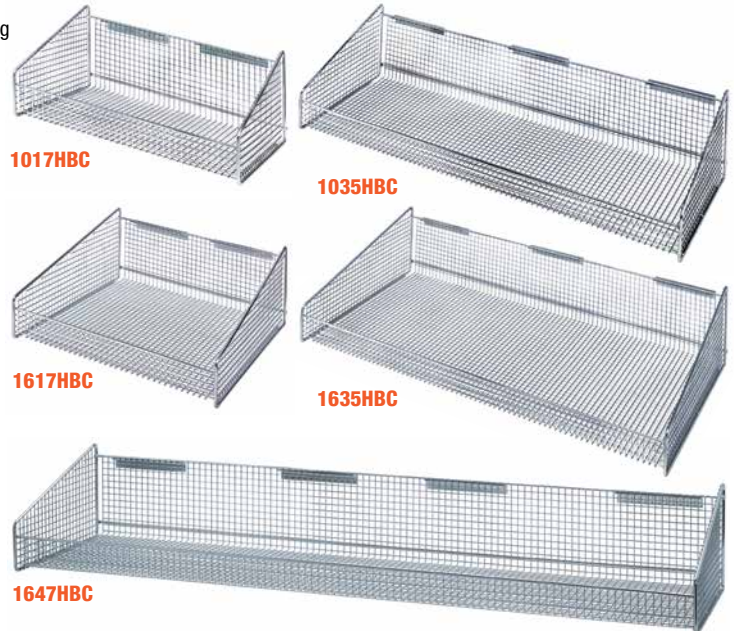

**Dividers**

**8 SIZES AVAILABLE**

MODEL NO.	DIMENSIONS W" x H"	SHIP WGT
<b>Hanging Basket Dividers</b>		
4X3HBD	3" x 4-1/2"	1 lb
4X6HBD	6" x 4-1/2"	1 lb
4X9HBD	9" x 4-1/2"	1 lb
4X15HBD	15" x 4-1/2"	2 lbs
1006DHB	10" x 6"	1 lb
1606DHB	16" x 6"	2 lbs
1006DHB-SQ	10" x 6"	1 lb
1606DHB-SQ	16" x 6"	2 lbs

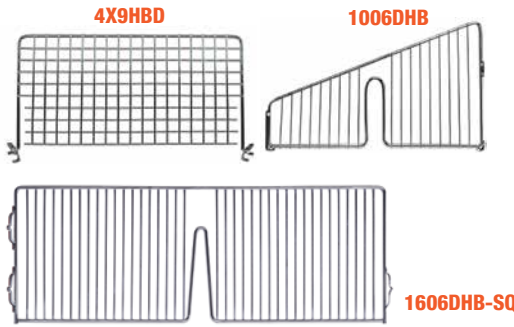

Separate product in basket with use of optional dividers. Dividers are used front to back to create individual compartments.

**Clear Label Holders**

Super easy method for identifying product. Affixes directly to the front on any basket. Four lengths available. (Label inserts sold separately).

MODEL NO.	DESCRIPTION	SHIP WGT
<b>Clear Label Holders</b>		
HBL3C	3" Clear Label Holder	1 lb
HBL165C	16-1/2" Clear Label Holder Fits 18" Basket	1 lb
HBL345C	34-1/2" Clear Label Holder Fits 36" Basket	1 lb
HBL465C	46-1/2" Clear Label Holder Fits 48" Basket	1 lb

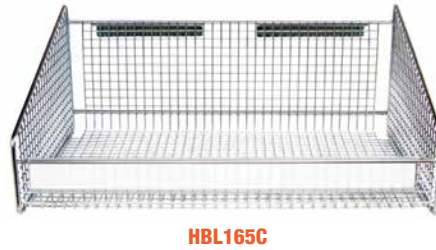

**Dust Shelves**

WS-1218DSHC

MODEL NO.	DIMENSIONS W" x L"	SHIP WGT
<b>Dust Shelves*</b>		
WS-1218DSHC	12" x 18"	5 lbs
WS-1236DSHC	12" x 36"	10 lbs
WS-1248DSHC	12" x 48"	15 lbs
WS-1818DSHC	18" x 18"	7 lbs
WS-1836DSHC	18" x 36"	15 lbs
WS-1848DSHC	18" x 48"	20 lbs

\*Dust Shelves not designed for load bearing

**Spikes & Holders**

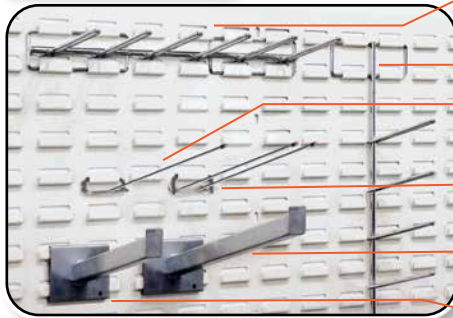

**WS-HTH**  
Horizontal Tape/Reel Holder  
Up to 25 lb. load capacity

**WS-VTH**  
Vertical Tape/Reel Holder  
Up to 25 lb. load capacity

**WS-SR9C**  
9" Single Rod  
Up to 15 lb. load capacity

**WS-DR10C**  
10" Double Rod  
Up to 15 lb. load capacity

**WS-HDS12**  
Heavy-Duty 12" Spike  
Up to 50 lb. load capacity

**WS-HDS6**  
Heavy-Duty 6" Spike  
Up to 65 lb. load capacity

**REQUIRED TO HANG BASKETS**

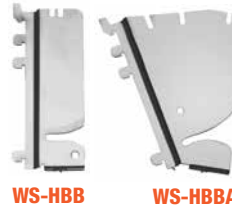

**Hanging Brackets**

MODEL NO.	DESCRIPTION	SHIP WGT
<b>Hanging Brackets</b>		
WS-HBB	90° Bracket Pair (2 pcs)	1 lb
WS-HBBA	Adjustable Bracket Pair (2 pcs)	1 lb

**Louvered Panels**

MODEL NO.	DIMENSIONS L" x H"	SHIP WGT
<b>Oyster White Louvered Panels</b>		
QLP-1861HC	18" x 61"	21 lbs
QLP-3661HC	36" x 61"	40 lbs
QLP-4861HC	48" x 61"	60 lbs

\*Louvered Panels require panel frame in order to affix to PARTition Wall Systems



**Hang Bars**

Used to mount wire louvered panels on PARTition Wall Systems. Wire Panels available on **pg. 7**

MODEL NO.	DESCRIPTION	SHIP WGT
<b>Hang Bars</b>		
WS-HB36HC	36" Hang Bar	4 lbs
WS-HB48HC	48" Hang Bar	5 lbs

**Kanban Indicator Lids**

Clear lid helps to identify when inventory levels are running low.

- Each includes 10 dividers, clips and labels.



**NEW** KBI-HB8757-10



MODEL NO.	DIMENSIONS W" x D" x H"	SHIP WGT
KBI-HB1757-10	1-3/4" x 7" x 1-1/2"	2 lbs
KBI-HB2757-10	2-3/4" x 7" x 1-1/2"	2 lbs
KBI-HB3757-10	3-3/4" x 7" x 1-1/2"	2 lbs
KBI-HB5757-10	5-3/4" x 7" x 1-1/2"	3 lbs
KBI-HB8757-10	8-3/4" x 7" x 1-1/2"	4 lbs
KBI-HB11757-10	11-3/4" x 7" x 1-1/2"	5 lbs
KBI-HB17007-10	17" x 7" x 1-1/2"	6 lbs
KBI-HB20007-10	20" x 7" x 1-1/2"	7 lbs
KBI-HB24007-10	24" x 7" x 1-1/2"	8 lbs
KBI-HB35007-10	35" x 7" x 1-1/2"	12 lbs

**PARTition Store Pull Out Basket Carts**

**Up to 800 lb. MOBILE LOAD CAPACITY**

Pull out basket storage organize and transport your storage tools and needed parts.

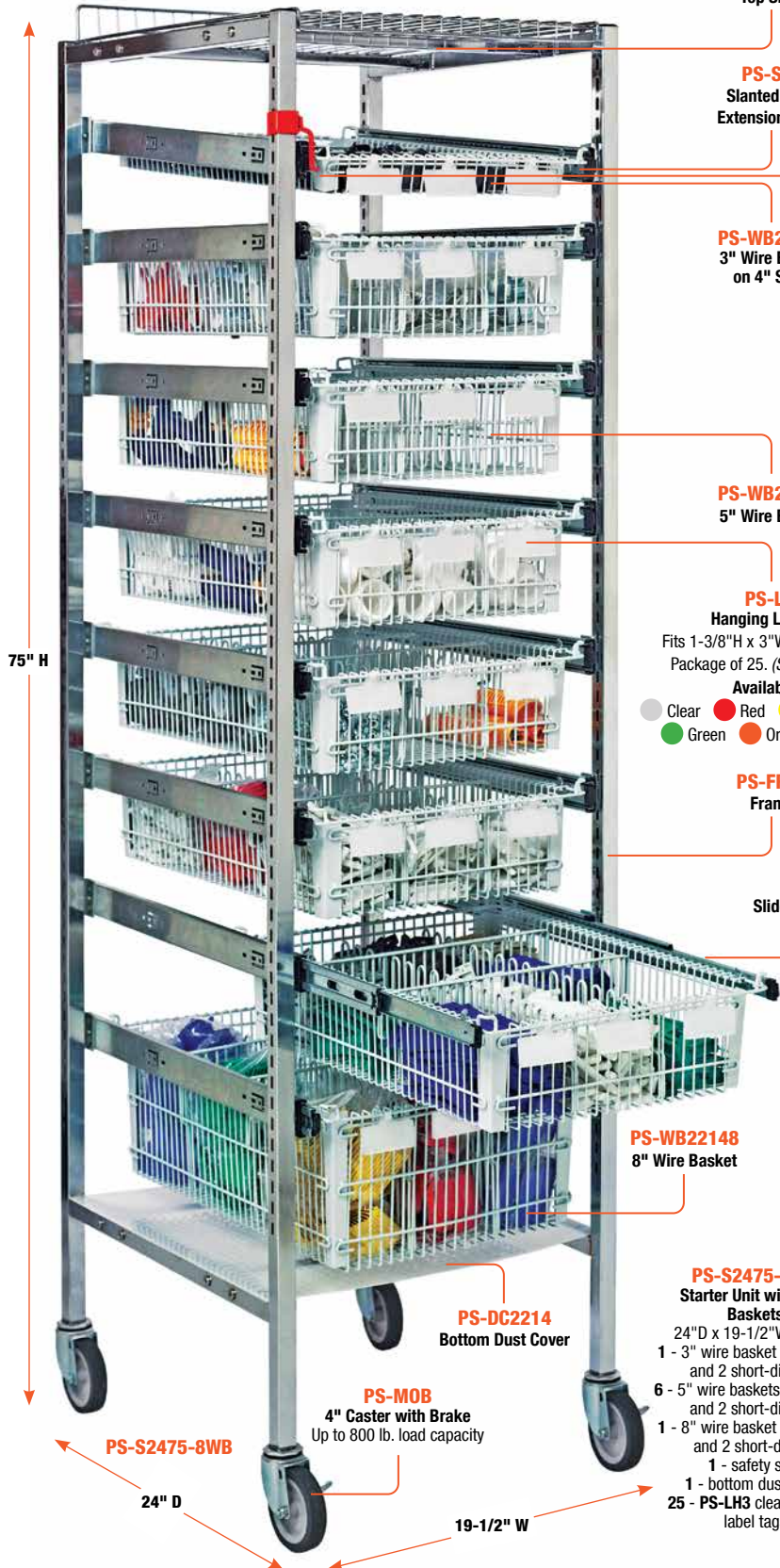

**PS-TS22184**  
Top Shelf

**PS-SSE**  
Slanted Slide Extension - Pair

**PS-WB22143**  
3" Wire Basket on 4" Slant



**PS-RSS**  
Red Safety Stop  
Used to secure wire baskets from sliding out when used on slanted slide.

**PS-WB22145**  
5" Wire Basket

**PS-LH3**  
Hanging Label Tag  
Fits 1-3/8"H x 3"W adhesive label.  
Package of 25. (Sold separately)  
Available in:  
● Clear ● Red ● Yellow ● Blue  
● Green ● Orange ● Purple

**PS-FR68**  
Frame

**PS-SE**  
Slide Extension - Pair

**PS-WB22148**  
8" Wire Basket

**PS-DC2214**  
Bottom Dust Cover

**PS-MOB**  
4" Caster with Brake  
Up to 800 lb. load capacity

**PS-S2475-8WB**  
Starter Unit with Wire Baskets  
24"D x 19-1/2"W x 75"H  
1 - 3" wire basket with 2 long and 2 short-dividers  
6 - 5" wire baskets with 2 long and 2 short-dividers  
1 - 8" wire basket with 2 long and 2 short-dividers  
1 - safety stop  
1 - bottom dust cover  
25 - PS-LH3 clear hanging label tags

**PARTition Store Starter Unit**

Starter units come complete with 2 frames, 4 cross bars, top wire shelf, full extension slides, bottom dust cover and four 4"H poly casters, 2 with brakes. Load capacity of up to 800 lb.



**PS-S2475-7S**  
Starter Unit with Wire Shelves  
24"D x 19-1/2"W x 75"H  
7 - wire shelves on slides  
1 - bottom dust cover  
25 - PS-LH3 clear hanging label tags

**PARTition Store Add-On Unit**

Add-on units come complete with 1 frame, 4 cross bars, top wire shelf, full extension slides, bottom dust cover and two 4"H casters, 1 with brake.

**EXPAND YOUR STARTER UNIT**



**PS-A2475-8WB**  
Add-on with Wire Baskets



**PS-A2475-7S**  
Add-on with Wire Shelves

**PARTITION Store Double Bay Carts**

- Ideal for transport of your needed parts or tools
- All-welded 1-1/2" square tubular epoxy-coated steel frame
- Sturdy base with solid shelf insert
- 5" quiet poly swivel casters
- Standard donut bumpers on corners which protect walls and provide cushion impact
- Accessories include dividers and label holders
- Custom configurations are available, call for details

**Up to 1,200 lb.**  
**MOBILE LOAD CAPACITY**  
**FOR BAY CARTS**



**PS-DBC-7WB7S**

**Double Bay Cart with Wire Baskets and Shelves**  
29-1/2"D x 44"W x 74-1/2"H  
7 - 5" wire baskets with 2 long and 2 short dividers  
7 - wire shelves on slides  
50 - PS-LH3 clear hanging label tags

Also available:  
**PS-DBC-14WB**

**Double Bay Cart with Wire Baskets**  
29-1/2"D x 44"W x 74-1/2"H  
14 - 5" wire baskets with 2 long and 2 short dividers  
50 - PS-LH3 clear hanging label tags

**PS-DBC-14S**

**Double Bay Cart with Wire Shelves**  
29-1/2"D x 44"W x 74-1/2"H  
14 - wire shelves on slides  
50 - PS-LH3 clear hanging label tags

**EACH BASKET AND SHELF CAN SUPPORT**

**Up to 60 lbs.**  
*(One tray extended at a time)*

**DOUBLE BAY HEAVY-DUTY PULL OUT BASKET TRANSPORT CARTS**

**Accessories**

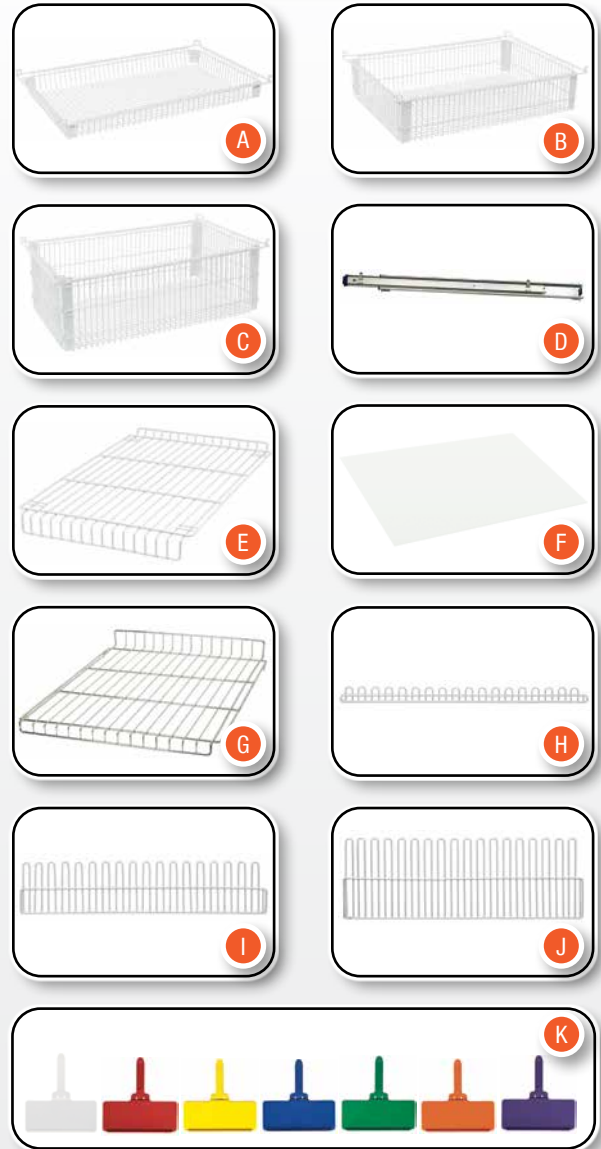

- (A) PS-WB22143**  
3" Wire Basket  
22" x 14" x 3"
- (B) PS-WB22145**  
5" Wire Basket  
22" x 14" x 5"
- (C) PS-WB22148**  
8" Wire Basket  
22" x 14" x 8"
- (D) PS-SE**  
Slide Extension - Pair  
**PS-SSE**  
Slant Slide Extension - Pair
- (E) PS-WS2414**  
Flat Shelf available in:  
- White  
- Chrome
- (F) PS-DC2214**  
Bottom Dust Cover  
22" x 14"
- (G) PS-TS22184C**  
Chrome Top Shelf
- (H) PS-WBLD-3**  
3" Basket Long Divider  
**PS-WBSD-3**  
3" Basket Short Divider
- (I) PS-WBLD-5**  
5" Basket Long Divider  
**PS-WBSD-5**  
5" Basket Short Divider
- (J) PS-WBLD-8**  
8" Basket Long Divider  
**PS-WBSD-8**  
8" Basket Short Divider
- (K) PS-LH3**  
Hanging Label Tag  
1-3/8" x 3" Available in:  
- Clear - Red - Yellow  
- Blue - Green - Orange  
- Purple

# MAXIMUM EFFICIENCY

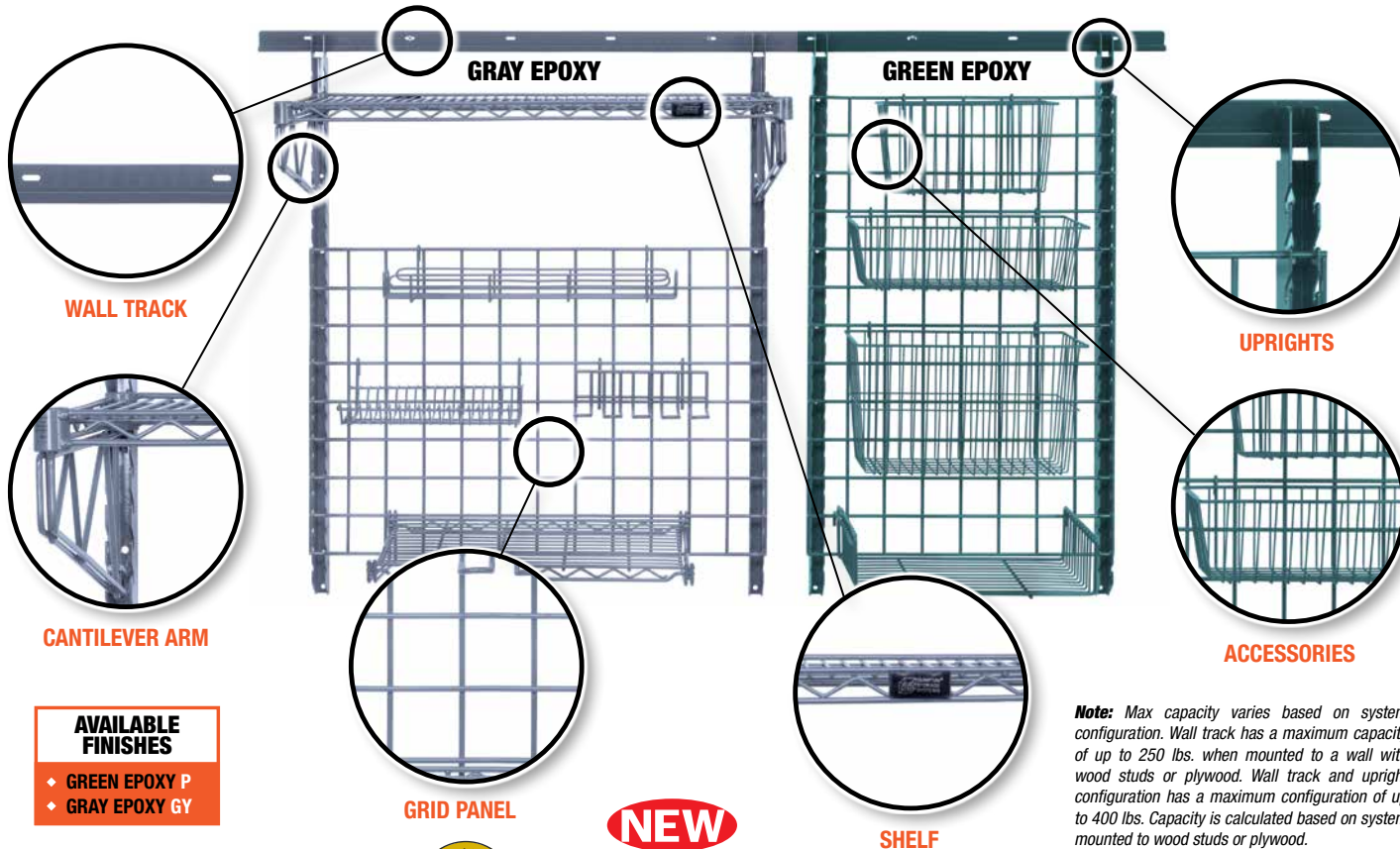

**AVAILABLE FINISHES**

- ♦ GREEN EPOXY P
- ♦ GRAY EPOXY GY



**NEW**  
**GRAY EPOXY FINISH**

**Note:** Max capacity varies based on system configuration. Wall track has a maximum capacity of up to 250 lbs. when mounted to a wall with wood studs or plywood. Wall track and upright configuration has a maximum configuration of up to 400 lbs. Capacity is calculated based on system mounted to wood studs or plywood.

## Store Grid Mount System

A versatile storage, utility, and display system suited to maximize efficiencies of underutilized spaces and empty walls. Store Grid is an easy to use system that integrates wall tracks, grids, wall shelving, and accessories in custom configurations and lengths. The use of the system around and above equipment will keep these areas cleaner and more organized. Store Grid enables the flexibility to add wall shelving and wall mounted task stations to any space for ease of accessibility and functionality. The durability of the 15 year warranty antimicrobial epoxy and robust design of the system protects against product degradation and ensures easy installation and maintenance.

**Finishes:** Proform Green and Gray Epoxy

- Antimicrobial additive protects the epoxy from bacteria, mold, and mildew that causes stains, odors, and product degradation.
- Keep small wares, utilities, inventory, tools, containers, utensils, and supplies off of the work surface and organized for fast, easy access. The work area remains clean and free from clutter to increase efficiencies.
- Grids attach to the uprights and enable the customizable configurations of accessories - bulk storage shelves, small supply shelves, baskets, hooks, drying rack accessories, utensil holders, bins, small utility racks, and a variety of holders.
- Easy installation and assembly. Mount the wall track and configure a customized work space using uprights, grids, shelves, and accessories.



**IDEAL FOR MAXIMIZING EFFICIENCY IN ANY PREPARATION, STORAGE OR WORK SPACE**

## TO ORDER:

1. Select size of Store Grid wall tracks depending on the space you have
2. Select size and quantity of uprights
3. Select number of shelves and cantilevers (two per shelf)
4. Select grid and accessories

## Product Notes

When configuring task stations with uprights, select shelves and grids of the same length. Longer grids may be used, although must not overhang the upright by more than 6" on either side. Grids may be mounted behind shelves. However, shelf support and grid cannot use the same slots on the upright. Maximum usable wall track mounting space is the track length minus 2" (stop fasteners are installed at each end of a run of wall track and occupy around 1" of track space on each end)

Shelves, shelf brackets, grids, and accessories may be removed for in-depth cleaning of walls. Wall tracks and uprights can be wiped clean. **Note:** Do not use abrasive chemicals or materials since these may damage the protective coating. Clean with mild detergents and damp cloths.

## Recommendations

**Wash Stations:** use shelves, baskets, drying racks and hooks for proper air drying of items used in food preparation.

**Prep Stations:** use shelves, baskets, bins, hooks, spice rack, and glove box holder for a neater work space.

**FLEXIBLE - WALL TRACKS AND UPRIGHTS ARE DESIGNED TO INTERFACE WITH WOOD STUDS, PLYWOOD, CONCRETE, AND OTHER SUITABLE WALL SURFACES**

**Wall Tracks**

12 gauge cold rolled steel; obround mounting holes located at 8" increments; first and last holes are located 4" from the ends of the track; obround hole dimensions (1/8" x 3/4"). Wall tracks include stop fasteners for the ends of the tracks and joiner plates for connecting adjacent tracks. Hardware not included.



**SG-WT56P**  
Wall Track  
56"

**Uprights**

12 gauge cold rolled steel; slotted every 1-1/2"; 1-1/8" diameter mounting holes are spaced every 6" along the upright, sold by each upright. These slots attach to grids and shelf supports in a clip-in function.



Upright

**Wire Grids**

1/4" diameter cold rolled steel wire create with 3" x 3" openings that are easily attached to the uprights.

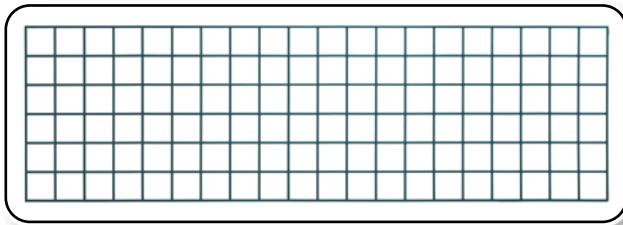

**SG-1860P**  
Wire Grid  
18" x 60"

**Cantilevers**

Mounts directly onto uprights. Available in single and double configurations, and in four different depths. Two single cantilevers are required for each end of a unit. Sold by the each.

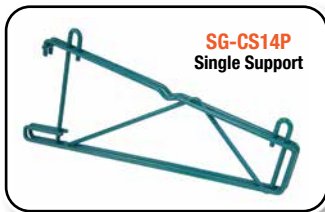

**SG-CS14P**  
Single Support

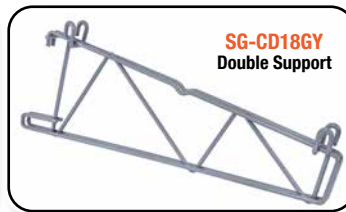

**SG-CD18GY**  
Double Support

**Brackets**

For use in light and standard-duty applications without uprights. One kit required per grid.

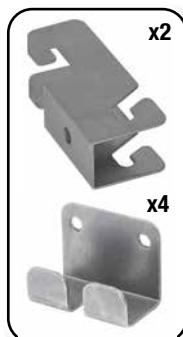

**SG-WTBS**  
Mounting Bracket  
Kit For Wall Track  
(Pack of 6)



**SG-WTBGY**  
Mounting Bracket  
Kit For Wall Track  
(Pack of 6)



**SG-DWB**  
Mounting  
Bracket Kit  
For Wall  
(Pack of 6)



**SG-PWM**  
Plastic Grid  
Mounting  
Bracket Kit  
For Wall  
(Pack of 6)

Metal finishes: P GY

PROFORM MODEL NO.	GRAY MODEL NO.	DESCRIPTION	CTN QTY	CTN WGT
<b>Store Grid Wall Mount Tracks</b>				
<b>SG-WT40P</b>	<b>SG-WT40GY</b>	40" Wall Track	1	5 lbs
<b>SG-WT56P</b>	<b>SG-WT56GY</b>	56" Wall Track	1	6 lbs
<b>SG-WT72P</b>	<b>SG-WT72GY</b>	72" Wall Track	1	7 lbs

Metal finishes: P GY

PROFORM MODEL NO.	GRAY MODEL NO.	DESCRIPTION	CTN QTY	CTN WGT
<b>Store Grid Wall Mount Uprights</b>				
<b>SG-U16P</b>	<b>SG-U16GY</b>	16" Upright	1	2 lbs
<b>SG-U31P</b>	<b>SG-U31GY</b>	31" Upright	1	4 lbs
<b>SG-U44P</b>	<b>SG-U44GY</b>	44-1/2" Upright	1	5 lbs

Metal finishes: P GY

PROFORM MODEL NO.	GRAY MODEL NO.	DESCRIPTION	CTN QTY	CTN WGT
<b>Store Grid Wall Mount Grids</b>				
<b>SG-1830P</b>	<b>SG-1830GY</b>	18" x 30" Grid	1	8 lbs
<b>SG-1836P</b>	<b>SG-1836GY</b>	18" x 36" Grid	1	9 lbs
<b>SG-1848P</b>	<b>SG-1848GY</b>	18" x 48" Grid	1	12 lbs
<b>SG-1860P</b>	<b>SG-1860GY</b>	18" x 60" Grid	1	14 lbs
<b>SG-2430P*</b>	<b>SG-2430GY</b>	24" x 30" Grid	1	10 lbs
<b>SG-2436P</b>	<b>SG-2436GY</b>	24" x 36" Grid	1	12 lbs
<b>SG-2448P</b>	<b>SG-2448GY</b>	24" x 48" Grid	1	15 lbs
<b>SG-3036P</b>	<b>SG-3036GY</b>	30" x 36" Grid	1	13 lbs
<b>SG-3048P</b>	<b>SG-3048GY</b>	30" x 48" Grid	1	17 lbs
<b>SG-3354P</b>	<b>SG-3354GY</b>	33" x 54" Grid	1	21 lbs

\*COMING SOON!

Metal finishes: P GY

PROFORM MODEL NO.	GRAY MODEL NO.	DESCRIPTION	CTN QTY	CTN WGT
<b>Store Grid Wall Mount Tracks</b>				
<b>SG-CS14P</b>	<b>SG-CS14GY</b>	14" Shelf Single Cantilever	1	3 lbs
<b>SG-CS18P</b>	<b>SG-CS18GY</b>	18" Shelf Single Cantilever	1	3 lbs
<b>SG-CS21P</b>	<b>SG-CS21GY</b>	21" Shelf Single Cantilever	1	4 lbs
<b>SG-CS24P</b>	<b>SG-CS24GY</b>	24" Shelf Single Cantilever	1	4 lbs
<b>SG-CD14P</b>	<b>SG-CD14GY</b>	14" Shelf Double Cantilever	1	3 lbs
<b>SG-CD18P</b>	<b>SG-CD18GY</b>	18" Shelf Double Cantilever	1	3 lbs
<b>SG-CD21P</b>	<b>SG-CD21GY</b>	21" Shelf Double Cantilever	1	4 lbs
<b>SG-CD24P</b>	<b>SG-CD24GY</b>	24" Shelf Double Cantilever	1	4 lbs

Shelf Cantilevers provide support for Quantum 14", 18", 21" and 24" epoxy shelves. Double Cantilevers are used for a side-by-side configuration.

Finishes: S GY BK

MODEL NO.	DESCRIPTION	CTN QTY	CTN WGT
<b>Store Grid Wall Mount Bracket</b>			
<b>SG-DWB</b>	Stainless Steel Mounting Bracket Kit For Wall (Pack of 6)	1	2 lbs
<b>SG-PWM</b>	Plastic Grid Mounting Bracket Kit For Wall (Pack of 6)	1	2 lbs
<b>SG-WTBS</b>	Stainless Steel Mounting Bracket Kit For Wall Track (Pack of 6)	1	2 lbs
<b>SG-WTBGY</b>	Epoxy Gray Mounting Bracket Kit For Wall Track (Pack of 6)	1	2 lbs

**Store Grid Kits**

**SGK-2448-1P**

**Light-Duty Task Station**

- Wall storage space ideal for Prep Stations
- 24" x 48" grid space
- Easy to rearrange accessories
- Antimicrobial additive protects the epoxy coating from bacteria, mold, and mildew.

Metal finishes: **▲P ▲GY**

Ship Weight - 47 lbs

Unit consists of:

- 1 - Wire Grid - **SG-2448P**
- 1 - Basket 17-3/8" x 7-1/2" x 5" - **SG-B1775P**
- 1 - Basket 17-3/8" x 7-1/2" x 10" - **SG-B17710P**
- 6 - Hook - **SG-HOOK6P**
- 6 - Hook - **SG-HOOKSM**
- 1 - Mounting Bracket - **SG-DWB**

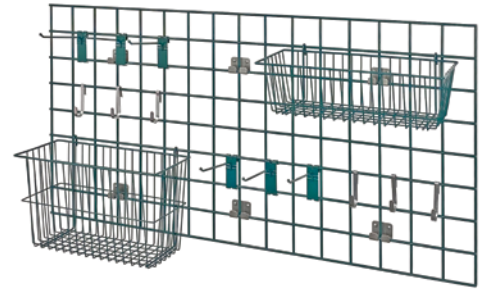

**SGK-3036-1GY**

**Light-Duty Task Station**

- Wall storage space ideal for Wash Stations
- 30" x 36" grid space
- Easy to rearrange accessories
- Antimicrobial additive protects the epoxy coating from bacteria, mold, and mildew.

Metal finishes: **▲P ▲GY**

Ship Weight - 44 lbs

Unit consists of:

- 1 - Wire Grid - **SG-3036GY**
- 1 - Basket 17-3/8" x 7-1/2" x 5" - **SG-B1775GY**
- 1 - Basket 17-3/8" x 7-1/2" x 10" - **SG-B17710GY**
- 1 - Shelf 9" x 18" - **SG-S918GY**
- 1 - Drying Rack - **SG-LH1384GY**
- 1 - Utensil Holder - **SG-UH4GY**
- 1 - Hook - **SG-HOOK6GY**
- 2 - Hook - **SG-HOOKSM**
- 1 - Hook - **SG-HOOKDB**
- 1 - Mounting Bracket - **SG-DWB**

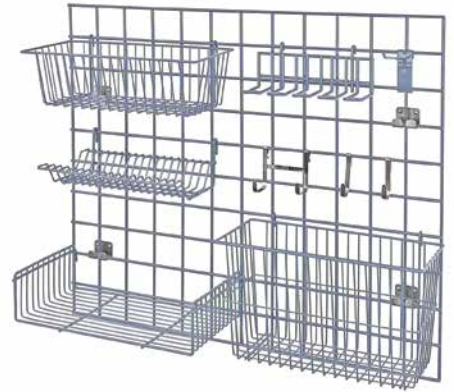

**SGK-401836-1P**

**Medium-Duty Task Station**

- Wall storage space with a 1836P wire shelf
- 18" x 36" grid space
- 40" track
- Antimicrobial additive protects the epoxy coating from bacteria, mold, and mildew.

Metal finishes: **▲P ▲GY**

Ship Weight - 38 lbs

Unit consists of:

- 1 - Wall Track - **SG-WT40P**
- 2 - Upright - **SG-U31P**
- 2 - Single Cantilever Arm - **SG-CS18P**
- 1 - Shelf 18" x 36" - **1836P**
- 1 - Wire Grid - **SG-1836P**

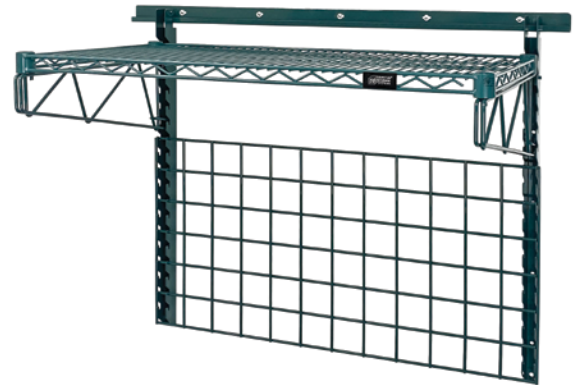

**SGK-401836-2GY**

**Medium-Duty Task Station**

- Wall storage space with a 1836P wire shelf, ideal for Wash Stations
- 18" x 36" grid space
- 40" track
- Antimicrobial additive protects the epoxy coating from bacteria, mold, and mildew.

Metal finishes: **▲P ▲GY**

Ship Weight - 57 lbs

Unit consists of:

- 1 - Wall Track - **SG-WT40GY**
- 2 - Upright - **SG-U31GY**
- 2 - Single Cantilever Arm - **SG-CS18GY**
- 1 - Shelf 18" x 36" - **1836GY**
- 1 - Wire Grid - **SG-1836GY**
- 1 - Basket 17-3/8" x 7-1/2" x 5" - **SG-B1775GY**
- 1 - Drying Rack - **SG-LH1384GY**
- 1 - Flatware Cylinder - **SG-CH**
- 1 - Cylinder Holder - **SG-CMBGY**
- 2 - Hook - **SG-HOOK6GY**
- 6 - Hook - **SG-HOOKSM**



**Store Grid Kits**

**SGK-401836-3P**

**Medium-Duty Task Station**

- Wall storage space with an 18" x 36" wire and solid shelf
- 18" x 36" grid space
- 40" track
- Antimicrobial additive protects the epoxy coating from bacteria, mold, and mildew.

Metal finishes: P GY

Ship Weight - 66 lbs

Unit consists of:

- 1 - Wall Track - **SG-WT40P**
- 2 - Upright - **SG-U44P**
- 4 - Single Cantilever Arm - **SG-CS18P**
- 1 - Shelf 18" x 36" - **1836P**
- 1 - Shelf 18" x 36" - **1836SG**
- 1 - Wire Grid - **SG-1836P**
- 1 - Shelf 16" x 16" - **SG-S1616P**
- 2 - Shelf 9" x 18" - **SG-S918P**



**SGK-401836-4GY**

**Medium-Duty Task Station**

- Wall storage space with a 1836GY wire shelf, ideal for Prep Stations
- 18" x 36" grid space
- 40" track
- Antimicrobial additive protects the epoxy coating from bacteria, mold, and mildew.

Bin available in: BL GN IV RD YL BK CL

Metal finishes: P GY

Ship Weight - 65 lbs

Unit consists of:

- 1 - Wall Track - **SG-WT40GY**
- 2 - Upright - **SG-U31GY**
- 2 - Single Cantilever Arm - **SG-CS18GY**
- 1 - Shelf 18" x 36" - **1836GY**
- 1 - Wire Grid - **SG-1836GY**
- 1 - Basket 17-3/8" x 7-1/2" x 5" - **SG-B1775GY**
- 2 - Hook - **SG-HOOK6GY**
- 6 - Hook - **SG-HOOKSM**
- 1 - Shelf 9" x 18" - **SG-S918GY**
- 1 - Bin 10-7/8" x 5-1/2" x 5" - **QUS230**
- 1 - Bin Holder - **SG-SBH**

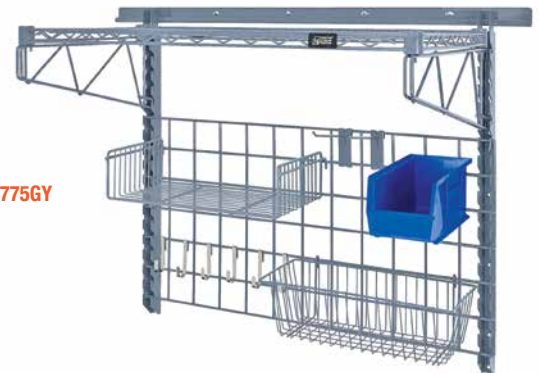

**SGK-402436-1P**

**Standard-Duty Task Station**

- Wall storage space with an 18" x 36" open grid polymer shelf
- 24" x 36" grid space
- 40" track
- Antimicrobial additive protects the epoxy coating from bacteria, mold, and mildew.

Metal finish: P

Ship Weight - 56 lbs

Unit consists of:

- 1 - Wall Track - **SG-WT40P**
- 2 - Single Cantilever Arm - **SG-CS18P**
- 1 - Shelf 18" x 36" - **1836WPM**
- 1 - Wire Grid - **SG-2436P**
- 2 - Basket 17-3/8" x 7-1/2" x 5" - **SG-B1775P**
- 2 - Utensil Holder - **SG-UH10P**
- 1 - Mounting Bracket - **SG-WTBP**

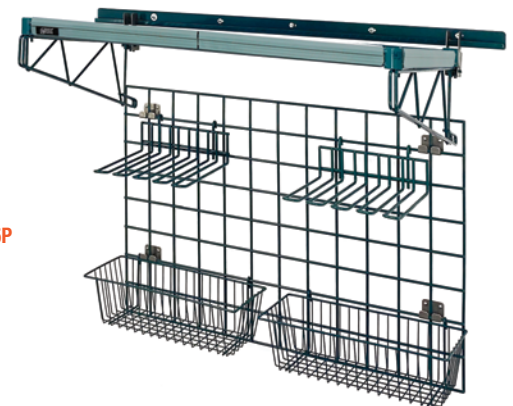

**SGK-403036-1GY**

**Standard-Duty Task Station**

- Wall storage space with an 18" x 36" grid shelf
- 30" x 36" grid space
- 40" track
- Antimicrobial additive protects the epoxy coating from bacteria, mold, and mildew.

Metal finishes: P GY

Ship Weight - 22 lbs

Unit consists of:

- 1 - Wall Track - **SG-WT40GY**
- 1 - Wire Grid - **SG-3036GY**
- 1 - Shelf 18" x 36" - **SG-LS1836GY**
- 1 - Mounting Bracket - **SG-WTBP**

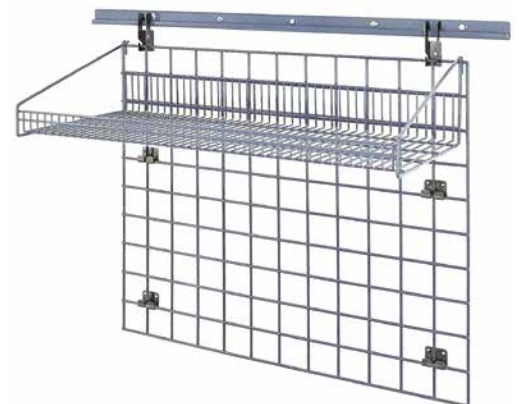

**Store Grid Kits**

**SGK-403036-2GY**

**Standard-Duty Task Station**

- Wall storage space with an 18" x 36" grid shelf
- 30" x 36" grid space
- 40" track
- Antimicrobial additive protects the epoxy coating from bacteria, mold, and mildew.

Bin available in: ● BL ● GN ● IV ● RD ● YL ● BK ● CL

Metal finishes: ▲ P ▲ GY

Ship Weight - 44 lbs

Unit consists of:

- 1 - Wall Track - **SG-WT40GY**
- 1 - Wire Grid - **SG-3036GY**
- 1 - Shelf 18" x 36" - **SG-LS1836GY**
- 1 - Basket 17-3/8" x 7-1/2" x 5" - **SG-B1775GY**
- 2 - Hook - **SG-HOOK6GY**
- 10 - Hook - **SG-HOOKSM**
- 1 - Shelf 9" x 18" - **SG-S918GY**
- 1 - Bin 10-7/8" x 5-1/2" x 5" - **QUS230**
- 1 - Bin Holder - **SG-SBH**
- 1 - Mounting Bracket - **SG-WTBGY**

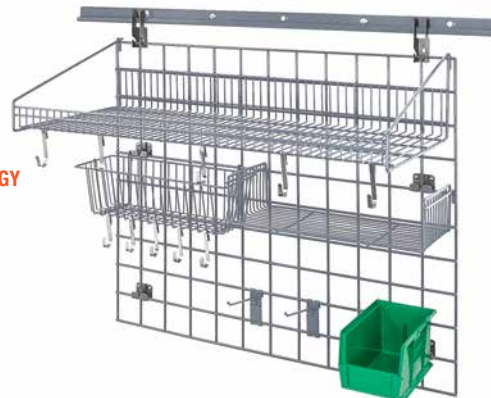

**SGK-403036-3P**

**Medium-Duty Task Station**

- Wall storage space with an 18" x 36" grid shelf, ideal for Wash Stations
- 30" x 36" grid space
- 40" track
- Antimicrobial additive protects the epoxy coating from bacteria, mold, and mildew.

Metal finishes: ▲ P ▲ GY

Ship Weight - 60 lbs

Unit consists of:

- 1 - Wall Track - **SG-WT40P**
- 2 - Upright - **SG-U31P**
- 1 - Wire Grid - **SG-3036P**
- 1 - Shelf 18" x 36" - **SG-LS1836P**
- 1 - Shelf 9" x 18" - **SG-S918P**
- 1 - Basket 13-3/8" x 5" x 7" - **SG-B1357P**
- 1 - Basket 17-3/8" x 7-1/2" x 5" - **SG-B1775P**
- 1 - Basket 17-3/8" x 7-1/2" x 10" - **SG-B17710P**
- 1 - Flatware Cylinder - **SG-CH**
- 1 - Cylinder Holder - **SG-CMBP**
- 2 - Hook - **SG-HOOK6P**



**SGK-562448-1GY**

**Medium-Duty Task Station**

- Wall storage space with 1848P wire shelves, ideal for Wash Stations
- 24" x 48" grid space
- 56" track
- Antimicrobial additive protects the epoxy coating from bacteria, mold, and mildew.

Metal finishes: ▲ P ▲ GY

Ship Weight - 92 lbs

Unit consists of:

- 1 - Wall Track - **SG-WT56GY**
- 2 - Upright - **SG-U44GY**
- 4 - Single Cantilever Arm - **SG-CS18GY**
- 2 - Shelf 18" x 48" - **1848GY**
- 1 - Wire Grid - **SG-2448GY**
- 1 - Basket 17-3/8" x 7-1/2" x 5" - **SG-B1775GY**
- 1 - Drying Rack - **SG-LH1384GY**
- 1 - Flatware Cylinder - **SG-CH**
- 1 - Cylinder Holder - **SG-CMBGY**
- 4 - Hook - **SG-HOOK6GY**
- 6 - Hook - **SG-HOOKSM**



**SGK-563048-1P**

**Medium-Duty Task Station**

- Wall storage space ideal for Wash Stations
- 30" x 48" grid space
- 56" track
- Antimicrobial additive protects the epoxy coating from bacteria, mold, and mildew.

Metal finishes: ▲ P ▲ GY

Ship Weight - 59 lbs

Unit consists of:

- 1 - Wall Track - **SG-WT56P**
- 2 - Upright - **SG-U31P**
- 1 - Wire Grid - **SG-3048P**
- 1 - Drying Rack - **SG-TDR461410P**
- 2 - Drying Rack - **SG-SLH201412P**
- 2 - Bottle Holder - **SG-BR6P**
- 2 - Hook - **SG-HOOK6P**

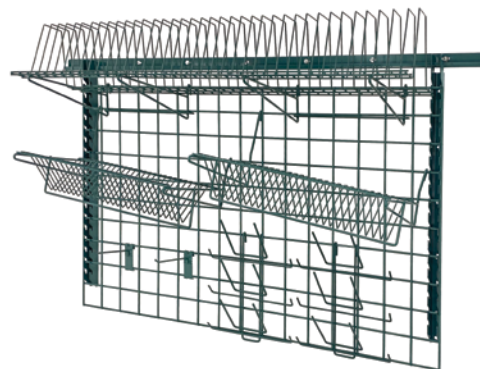

**Store Grid Kits**

**SGK-721830-1P**

**Medium-Duty Task Station**

- Wall storage space ideal for Wash Stations
- 36" x 60" grid space
- 72" track
- Antimicrobial additive protects the epoxy coating from bacteria, mold, and mildew.

Metal finishes: **P** **GY**

Ship Weight - 89 lbs

Unit consists of:

- 1 - Wall Track - **SG-WT72P**
- 4 - Upright - **SG-U44P**
- 4 - Wire Grid - **SG-1830P**
- 2 - Shelf 18" x 30" - **SG-LS1830P**
- 2 - Flatware Cylinder - **SG-CH**
- 2 - Cylinder Holder - **SG-CMBP**
- 2 - Utensil Holder - **SG-UH10P**
- 2 - Utensil Holder - **SG-UH4P**
- 2 - Drying Rack - **SG-LH1384P**



**SGK-723036-1GY**

**Medium-Duty Task Station**

- Wall storage space ideal for Wash Stations
- 30" x 72" grid space
- 72" track
- Antimicrobial additive protects the epoxy coating from bacteria, mold, and mildew.

Metal finishes: **P** **GY**

Ship Weight - 101 lbs

Unit consists of:

- 1 - Wall Track - **SG-WT72GY**
- 4 - Upright - **SG-U44GY**
- 2 - Wire Grid - **SG-3036GY**
- 2 - Shelf 18" x 36" - **SG-LS1836GY**
- 2 - Flatware Cylinder - **SG-CH**
- 2 - Cylinder Holder - **SG-CMBGY**
- 2 - Basket 17-3/8" x 7-1/2" x 10" - **SG-B17710GY**
- 2 - Drying Rack - **SG-LH1384GY**
- 4 - Hook - **SG-HOOK6GY**
- 10 - Hook - **SG-HOOKSM**



**SGK-803036-1P**

**Medium-Duty Task Station**

- Wall storage space with 1836P wire shelves, ideal for Prep Stations
- 30" x 72" grid space
- 80" track
- Antimicrobial additive protects the epoxy coating from bacteria, mold, and mildew.

Metal finishes: **P** **GY**

Ship Weight - 107 lbs

Unit consists of:

- 2 - Wall Track - **SG-WT40P**
- 3 - Upright - **SG-U44P**
- 2 - Single Cantilever Arm - **SG-CS18P**
- 1 - Double Cantilever Arm - **SG-CD18P**
- 2 - Shelf 18" x 36" - **1836P**
- 2 - Wire Grid - **SG-3036P**
- 1 - Shelf 18" x 36" - **SG-LS1836P**
- 1 - Basket 17-3/8" x 7-1/2" x 5" - **SG-B1775P**
- 3 - Utility Rack - **SG-SR2254P**
- 1 - Utensil Holder - **SG-UH10P**
- 2 - Hook - **SG-HOOK6P**

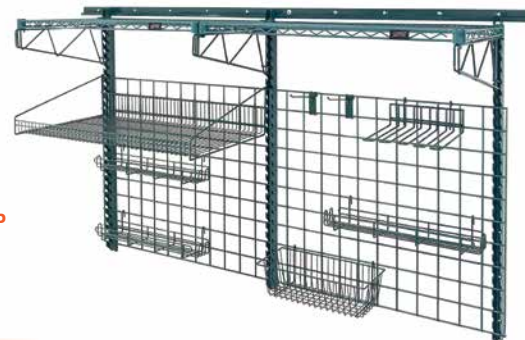

**SGK-961830-1GY**

**Medium-Duty Task Station**

- Wall storage space with 1830P wire shelves
- 96" track
- Antimicrobial additive protects the epoxy coating from bacteria, mold, and mildew.

Metal finishes: **P** **GY**

Ship Weight - 99 lbs

Unit consists of:

- 1 - Wall Track - **SG-WT56GY**
- 1 - Wall Track - **SG-WT40GY**
- 4 - Upright - **SG-U31GY**
- 4 - Single Cantilever Arm - **SG-CS18GY**
- 4 - Double Cantilever Arm - **SG-CD18GY**
- 6 - Shelf 18" x 30" - **1830GY**



**SG-A1**

**Accessory Pack 1**

- Fits a minimum of 18" x 36" grid space

Kit consists of:

- 1 - Basket 17-3/8" x 7-1/2" x 5" - **SG-B1775P**
- 1 - Drying Rack - **SG-LH1384P**
- 1 - Flatware Cylinder - **SG-CH**
- 1 - Cylinder Holder - **SG-CMBP**
- 2 - Hook - **SG-HOOK6P**
- 6 - Hook - **SG-HOOKSM**

Ship Weight - 22 lbs

Metal finishes: **P** **GY**

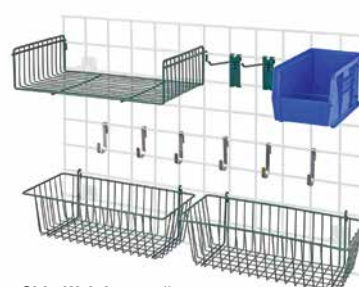

**SG-A2**

**Accessory Pack 2**

- Fits a minimum of 18" x 36" grid space

Kit consists of:

- 2 - Basket 17-3/8" x 7-1/2" x 5" - **SG-B1775P**
- 2 - Hook - **SG-HOOK6P**
- 6 - Hook - **SG-HOOKSM**
- 1 - Shelf 9" x 18" - **SG-S918P**
- 1 - Bin 10-7/8" x 5-1/2" x 5" - **QUS230**
- 1 - Bin Holder - **SG-SBH**

Ship Weight - 25 lbs

Metal finishes: **P** **GY**

Bin available in: **BL** **GN** **IV** **RD** **YL** **BK** **CL**

Store Grid Accessories

Metal finishes: P GY S

PROFORM MODEL NO.	GRAY MODEL NO.	DESCRIPTION	CTN QTY	CTN WGT
<b>Shelves</b>				
A SG-S918P	SG-S918GY	9" x 18" Shelf with Side Ledge	1	7 lbs
B SG-LS1436P	SG-LS1436GY	14" x 36" Large Grid Shelf with Front Ledge	1	8 lbs
SG-LS1448P	SG-LS1448GY	14" x 48" Large Grid Shelf with Front Ledge	1	10 lbs
SG-LS1830P	SG-LS1830GY	18" x 30" Large Grid Shelf with Front Ledge	1	9 lbs
SG-LS1836P	SG-LS1836GY	18" x 36" Large Grid Shelf with Front Ledge	1	10 lbs
SG-LS1848P	SG-LS1848GY	18" x 48" Large Grid Shelf with Front Ledge	1	13 lbs
C SG-S1224P	SG-S1224GY	12" x 24" Small Grid Shelf	1	6 lbs
D SG-S1616P	SG-S1616GY	16" x 16" Square Grid Shelf	1	5 lbs
<b>Baskets</b>				
E SG-B1357P	SG-B1357GY	13-3/8" x 5" x 7" Basket	1	9 lbs
F SG-B1775P	SG-B1775GY	17-3/8" x 7-1/2" x 5" Basket	1	7 lbs
G SG-B17710P	SG-B17710GY	17-3/8" x 7-1/2" x 10" Basket	1	11 lbs
<b>Hooks</b>				
H SG-HOOKSM	SG-HOOKSMGY	J Small Hook	1	1 lb
I SG-HOOKLG	SG-HOOKLGGY	J Shaped Large Hook	1	1 lb
J SG-HOOKDB	SG-HOOKDBGY	J Double Large Hook	1	1 lb
K SG-HOOK6P	SG-HOOK6GY	6" Hook	1	1 lb
L SG-HA5P	-	Hook Arm	1	1 lb
<b>Drying Racks</b>				
M SG-TDR341410P	SG-TDR341410GY	36" Tray Drying Rack	1	12 lbs
SG-TDR461410P	SG-TDR461410GY	48" Tray Drying Rack	1	13 lbs
N SG-SLH201412P	SG-SLH201412GY	Slanted Lid Holder/Drying Shelf	1	5 lbs
O SG-LH1384P	SG-LH1384GY	Lid Holder/Drying Shelf	1	2 lbs
P SG-BR6P	SG-BR6GY	6-Prong Bottle Rack	1	2 lbs
<b>Utensil Holders</b>				
Q SG-UH10P	SG-UH10GY	Large Utensil Holder	1	4 lbs
R SG-UH4P	SG-UH4GY	Small Utensil Holder	1	4 lbs
S SG-CMBP	SG-CMBGY	Cylinder Holder Mounting Bracket	1	1 lb
T SG-CH	-	Flatware Cylinder	1	1 lb
<b>Bin Holders</b>				
U SG-SBH	-	3"L x 3/4"W x 1-1/16"H - usable hanging space: 3" - Single Bin Holder	1	1 lb
V SG-SMBH	-	11-5/8"L x 3/4"W x 3-5/8"H - usable hanging space: 9-1/8" - Small Bin Holder	1	1 lb
W SG-LGBH	-	23-5/8"L x 3/4"W x 3-5/8"H - usable hanging space: 18-2/8" - Large Bin Holder	1	2 lbs
<b>Miscellaneous</b>				
X SG-SR2254P	SG-SR2254GY	Spice Rack Utility Rack	1	4 lbs
Y SG-IPH	-	Insert Pan Holder Plated	1	2 lbs
Z SG-HFF	-	Hanging File Folder Plated	1	3 lbs
AA SG-GBHP	SG-GBHGY	Glove Box Holder	1	2 lbs
AB SG-BH29P	SG-BH29GY	Book Holder 2" x 9"	1	3 lbs
AC SG-HOLDERP	SG-HOLDERGY	Paper Towel Holder	1	3 lbs

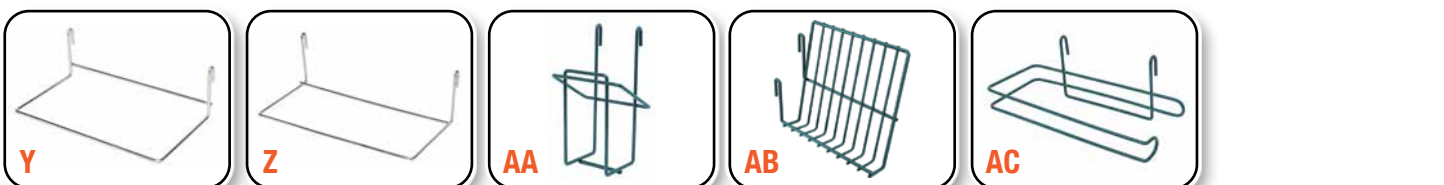
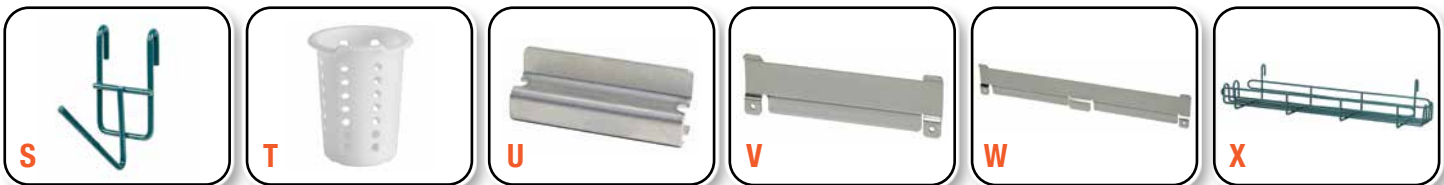
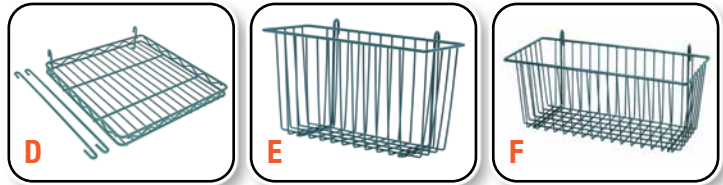

CUSTOMIZABLE CONFIGURATIONS USING A VARIETY OF ACCESSORIES



**DWB12, DWB14, DWB18, DWB21 or DWB24**  
Wire Cantilever Arm

- AVAILABLE FINISHES**
- ◆ CHROME
  - ◆ EPOXY GREEN P
  - ◆ EPOXY GRAY GY
  - ◆ EPOXY BLACK BK

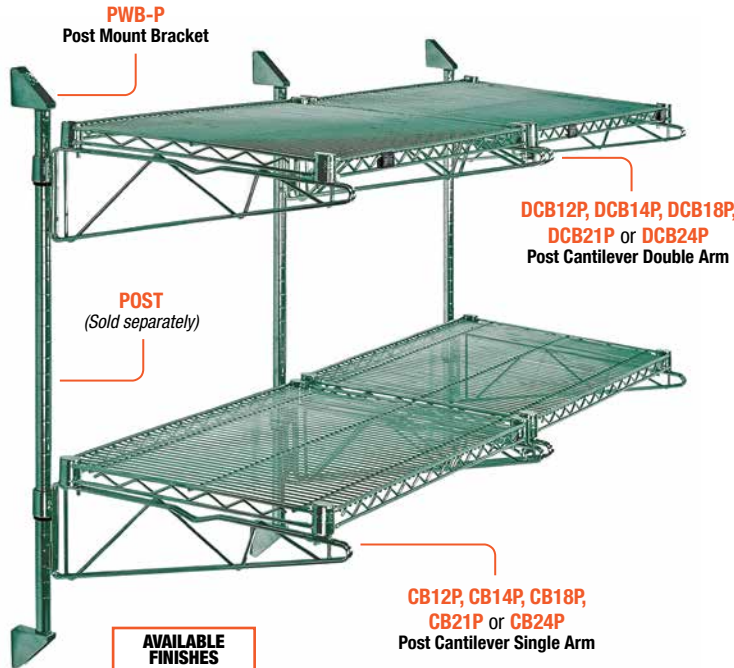

**PWB-P**  
Post Mount Bracket

**DCB12P, DCB14P, DCB18P, DCB21P or DCB24P**  
Post Cantilever Double Arm

**POST**  
(Sold separately)

**CB12P, CB14P, CB18P, CB21P or CB24P**  
Post Cantilever Single Arm

- AVAILABLE FINISHES**
- ◆ CHROME
  - ◆ STAINLESS S
  - ◆ EPOXY GREEN P
  - ◆ EPOXY GRAY GY
  - ◆ EPOXY BLACK BK

**PWB**  
**PWB-P**  
**PWB-GY**  
**PWB-BK**

**Post Mount Bracket**

Used to secure cantilever post mount units and free standing shelving units to wall. Sold in a pack of 4. (Mounting screws are not included)



**TO ORDER THIS EXACT CONFIGURATION, YOU WOULD ORDER THE FOLLOWING:**

- 2 - CB18P
- 2 - DCB18P
- 4 - 1836P
- 3 - P34P

To further extend the configuration shown by an additional section to the left or right, simply order:

- 2 - DCB18P
- 2 - 1836P
- 1 - P34P

To further extend the configuration shown by an additional shelf level, simply order:

- 1 - CB18P
- 1 - DCB18P
- 2 - 1836P

Your options are unlimited.

**Cantilever Single Shelf Wall Mount**



Cantilever shelving is an excellent way to create storage space when floor space isn't available. Simple in design, our cantilever shelving systems are easy to assemble and install. Select from five different depths: 12", 14", 18", 21" or 24". Two cantilever arms and 2 mounting brackets are included per order. Wire shelves are sold separately.

**TO CHOOSE FINISH ADD FINISH SUFFIX TO MODEL NO. Ex. DWB12P**

MODEL NO.	DESCRIPTION	SHIP WGT
<b>Chrome Cantilever Arms and Mounting Brackets</b>		
DWB12	2 - 12" Cantilever Arms & 2 Mounting Brackets	3 lbs
DWB14	2 - 14" Cantilever Arms & 2 Mounting Brackets	3 lbs
DWB18	2 - 18" Cantilever Arms & 2 Mounting Brackets	4 lbs
DWB21	2 - 21" Cantilever Arms & 2 Mounting Brackets	5 lbs
DWB24	2 - 24" Cantilever Arms & 2 Mounting Brackets	5 lbs
<b>Proform Green, Gray &amp; Black Epoxy Cantilever Arms and Mounting Brackets</b>		
DWB12 (P, GY, BK)	2 - 12" Epoxy Cantilever Arms & 2 Mounting Brackets	3 lbs
DWB14 (P, GY, BK)	2 - 14" Epoxy Cantilever Arms & 2 Mounting Brackets	3 lbs
DWB18 (P, GY, BK)	2 - 18" Epoxy Cantilever Arms & 2 Mounting Brackets	4 lbs
DWB21 (P, GY, BK)	2 - 21" Epoxy Cantilever Arms & 2 Mounting Brackets	5 lbs
DWB24 (P, GY, BK)	2 - 24" Epoxy Cantilever Arms & 2 Mounting Brackets	5 lbs
<b>Chrome Double Cantilever Arm and Mounting Bracket</b>		
DWBD12	1 - 12" Double Cantilever Arm & Mounting Bracket	3 lbs
DWBD14	1 - 14" Double Cantilever Arm & Mounting Bracket	3 lbs
DWBD18	1 - 18" Double Cantilever Arm & Mounting Bracket	4 lbs
DWBD21	1 - 21" Double Cantilever Arm & Mounting Bracket	5 lbs
DWBD24	1 - 24" Double Cantilever Arm & Mounting Bracket	5 lbs
<b>Proform Green, Gray &amp; Black Epoxy Double Cantilever Arm and Mounting Bracket</b>		
DWBD12 (P, GY, BK)	1 - 12" Epoxy Double Cantilever Arm & Mounting Bracket	3 lbs
DWBD14 (P, GY, BK)	1 - 14" Epoxy Double Cantilever Arm & Mounting Bracket	3 lbs
DWBD18 (P, GY, BK)	1 - 18" Epoxy Double Cantilever Arm & Mounting Bracket	4 lbs
DWBD21 (P, GY, BK)	1 - 21" Epoxy Double Cantilever Arm & Mounting Bracket	5 lbs
DWBD24 (P, GY, BK)	1 - 24" Epoxy Double Cantilever Arm & Mounting Bracket	5 lbs

**Cantilever Multiple Shelf Post Wall Mount**



Adjustable post wall mount systems use a post cantilever single arm of 12", 14", 18", 21" or 24" with appropriate shelf size and post height. Two post cantilever single arms and 4 post mount brackets are included per order.

Post Cantilever Double Arm is available in 12", 14", 18", 21" and 24" and uses the center post for continuous or add-on shelf sections. One post cantilever double arm and 2 post mount brackets are included per order. Wire shelves and posts are sold separately.

**TO CHOOSE FINISH ADD FINISH SUFFIX TO MODEL NO. Ex. CB12P**

MODEL NO.	DESCRIPTION	SHIP WGT
<b>Chrome Single Post Cantilever Arms</b>		
CB12	2 - 12" Single Post Cantilever Arms & 4 Post Mount Brackets	4 lbs
CB14	2 - 14" Single Post Cantilever Arms & 4 Post Mount Brackets	5 lbs
CB18	2 - 18" Single Post Cantilever Arms & 4 Post Mount Brackets	6 lbs
CB21	2 - 21" Single Post Cantilever Arms & 4 Post Mount Brackets	7 lbs
CB24	2 - 24" Single Post Cantilever Arms & 4 Post Mount Brackets	8 lbs
<b>Proform Green, Gray &amp; Black Epoxy Single Post Cantilever Arms</b>		
CB12 (P, GY, BK)	2 - 12" Single Post Cantilever Arms & 4 Post Mount Brackets	4 lbs
CB14 (P, GY, BK)	2 - 14" Single Post Cantilever Arms & 4 Post Mount Brackets	5 lbs
CB18 (P, GY, BK)	2 - 18" Single Post Cantilever Arms & 4 Post Mount Brackets	6 lbs
CB21 (P, GY, BK)	2 - 21" Single Post Cantilever Arms & 4 Post Mount Brackets	7 lbs
CB24 (P, GY, BK)	2 - 24" Single Post Cantilever Arms & 4 Post Mount Brackets	8 lbs
<b>Stainless Steel Single Post Cantilever Arms</b>		
CB14S	2 - 14" Single Post Cantilever Arms & 4 Post Mount Brackets	5 lbs
CB18S	2 - 18" Single Post Cantilever Arms & 4 Post Mount Brackets	6 lbs
<b>Chrome Double Post Cantilever Arms</b>		
DCB12	1 - 12" Double Post Cantilever Arm & 2 Post Mount Brackets	10 lbs
DCB14	1 - 14" Double Post Cantilever Arm & 2 Post Mount Brackets	11 lbs
DCB18	1 - 18" Double Post Cantilever Arm & 2 Post Mount Brackets	12 lbs
DCB21	1 - 21" Double Post Cantilever Arm & 2 Post Mount Brackets	13 lbs
DCB24	1 - 24" Double Post Cantilever Arm & 2 Post Mount Brackets	14 lbs
<b>Proform Green, Gray &amp; Black Epoxy Double Post Cantilever Arms</b>		
DCB12 (P, GY, BK)	1 - 12" Double Post Cantilever Arm & 2 Post Mount Brackets	10 lbs
DCB14 (P, GY, BK)	1 - 14" Double Post Cantilever Arm & 2 Post Mount Brackets	11 lbs
DCB18 (P, GY, BK)	1 - 18" Double Post Cantilever Arm & 2 Post Mount Brackets	12 lbs
DCB21 (P, GY, BK)	1 - 21" Double Post Cantilever Arm & 2 Post Mount Brackets	13 lbs
DCB24 (P, GY, BK)	1 - 24" Double Post Cantilever Arm & 2 Post Mount Brackets	14 lbs

Direct Wall Mount Cantilever Single Shelf Complete Packages



Versatile hanging system, ideal to create storage space in difficult spaces to accompany floor storage. Select from five different depths: 12", 14", 18", 21" or 24".

TO CHOOSE FINISH ADD FINISH SUFFIX TO MODEL NO. Ex. WDWB1224P



MODEL NO.	DIMENSION W" x L"	SHIP WGT
WDWB1224	12" x 24"	9 lbs
WDWB1230	12" x 30"	9 lbs
WDWB1236	12" x 36"	10 lbs
WDWB1242	12" x 42"	11 lbs
WDWB1248	12" x 48"	12 lbs
WDWB1260	12" x 60"	17 lbs
WDWB1272	12" x 72"	20 lbs
WDWB1424	14" x 24"	9 lbs
WDWB1430	14" x 30"	10 lbs
WDWB1436	14" x 36"	11 lbs
WDWB1442	14" x 42"	13 lbs
WDWB1448	14" x 48"	14 lbs
WDWB1454	14" x 54"	15 lbs
WDWB1460	14" x 60"	17 lbs
WDWB1472	14" x 72"	20 lbs
WDWB1824	18" x 24"	11 lbs
WDWB1830	18" x 30"	12 lbs
WDWB1836	18" x 36"	14 lbs
WDWB1842	18" x 42"	15 lbs
WDWB1848	18" x 48"	18 lbs
WDWB1854	18" x 54"	19 lbs
WDWB1860	18" x 60"	21 lbs
WDWB1872	18" x 72"	24 lbs
WDWB2124	21" x 24"	13 lbs
WDWB2130	21" x 30"	14 lbs
WDWB2136	21" x 36"	16 lbs
WDWB2142	21" x 42"	17 lbs
WDWB2148	21" x 48"	19 lbs
WDWB2154	21" x 54"	21 lbs
WDWB2160	21" x 60"	23 lbs
WDWB2172	21" x 72"	29 lbs
WDWB2424	24" x 24"	14 lbs
WDWB2430	24" x 30"	16 lbs
WDWB2436	24" x 36"	18 lbs
WDWB2442	24" x 42"	20 lbs
WDWB2448	24" x 48"	21 lbs
WDWB2454	24" x 54"	23 lbs
WDWB2460	24" x 60"	26 lbs
WDWB2472	24" x 72"	31 lbs



WDWB1230P Wall Mount Cantilever Single Shelf

DWB12P, DWB14P, DWB18P, DWB21P or DWB24P Wire Cantilever Arm

AVAILABLE FINISHES

- CHROME C
- EPOXY GREEN P
- EPOXY GRAY GY
- EPOXY BLACK BK

QUICK, EASY ASSEMBLY

Post Wall Mount Cantilever with Baskets Complete Packages

Modular Wire Baskets mount to standard post to utilize wall space efficiently. Baskets allow for high visibility and quick accessibility. Baskets are adjustable and removable. **Finish:** Chrome

MODEL NO.	NO. OF BASKETS	BASKET MODEL NO.	BASKET DIMENSIONS W" x L" x H"	SHIP WGT
<b>34"H - Wire Cantilever with Baskets - Complete Packages</b>				
CAN-34-1436BC-PWB	2	1436BC	14" x 36" x 9"	26 lbs
CAN-34-1448BC-PWB	2	1448BC	14" x 48" x 9"	32 lbs
CAN-34-2036BC-PWB	2	2036BC	20" x 36" x 9"	30 lbs
CAN-34-2048BC-PWB	2	2048BC	20" x 48" x 9"	36 lbs
CAN-34-203612BC-PWB	2	203612BC	20" x 36" x 12"	34 lbs
CAN-34-204812BC-PWB	2	204812BC	20" x 48" x 12"	38 lbs



OPTIONAL DIVIDERS AVAILABLE

TURN EMPTY WALLS INTO STORAGE SPACE

CAN-34-1436BC-PWB Baskets shown with Clear Label Holder (Sold separately)

COMPLETE PACKAGES WITH BASKETS



SCH1 Collar Hooks Hooks onto basket corner allowing basket to securely hang. See pg. 166

Post Wall Mount Cantilever with Bin Holders Complete Packages

Easy access, adjustable wall mounted bin systems. Available in 24", 30", 36", 48" and 60" widths. Optional bin dividers, windows fronts and clear label holders. **Finish:** Chrome

Bin available in: Blue Green Ivory Red Yellow Black Clear

MODEL NO.	NO. OF BIN RAILS	DIMENSIONS L" x H"	NO. OF BINS	BIN DIMENSIONS L" x W" x H"	SHIP WGT
<b>Wire Cantilever Bin Holder - Complete with Bins Available in Blue, Green, Ivory, Red, Yellow, Black and Clear</b>					
CAN-34-24BH-230	3	24" x 34"	9 QUS230	10-7/8" x 5-1/2" x 5"	18 lbs
CAN-34-30BH-230	3	30" x 34"	12 QUS230	10-7/8" x 5-1/2" x 5"	20 lbs
CAN-34-36BH-230	3	36" x 34"	18 QUS230	10-7/8" x 5-1/2" x 5"	26 lbs
CAN-34-48BH-230	3	48" x 34"	24 QUS230	10-7/8" x 5-1/2" x 5"	34 lbs
CAN-34-60BH-230	3	60" x 34"	30 QUS230	10-7/8" x 5-1/2" x 5"	42 lbs



CAN-34-36BH-230

COMPLETE PACKAGES WITH BINS



**LOWEST PRICE GUARANTEE**

**Post Wall Mount Cantilever Units 1, 2 & 3 Shelves  
Complete Packages**

Versatile hanging system, ideal to create storage space in difficult spaces to accompany floor storage. Select from five different depths: 12", 14", 18", 21" or 24". Available in 1, 2 or 3 shelf configurations.

TO CHOOSE FINISH ADD FINISH SUFFIX TO MODEL NO.

Ex. WC14-CB1224P

**NEW**

- AVAILABLE FINISHES**
- ◆ CHROME C
  - ◆ EPOXY GREEN P
  - ◆ EPOXY GRAY GY
  - ◆ EPOXY BLACK BK



**QUICK, EASY ASSEMBLY**



WC14-CB1230BK



WC34-CB1230GY



WC54-CB1230C

DIMENSION W" x L"	14" Post Wall Mount 1 Shelf		34" Post Wall Mount 2 Shelf		54" Post Wall Mount 3 Shelf	
	MODEL NO.	SHIP WGT	MODEL NO.	SHIP WGT	MODEL NO.	SHIP WGT
12" x 24"	WC14-CB1224	13 lbs	WC34-CB1224	26 lbs	WC54-CB1224	39 lbs
12" x 30"	WC14-CB1230	13 lbs	WC34-CB1230	26 lbs	WC54-CB1230	39 lbs
12" x 36"	WC14-CB1236	14 lbs	WC34-CB1236	28 lbs	WC54-CB1236	42 lbs
12" x 42"	WC14-CB1242	15 lbs	WC34-CB1242	34 lbs	WC54-CB1242	45 lbs
12" x 48"	WC14-CB1248	16 lbs	WC34-CB1248	36 lbs	WC54-CB1248	48 lbs
12" x 60"	WC14-CB1260	21 lbs	WC34-CB1260	38 lbs	WC54-CB1260	63 lbs
12" x 72"	WC14-CB1272	24 lbs	WC34-CB1272	42 lbs	WC54-CB1272	72 lbs
14" x 24"	WC14-CB1424	13 lbs	WC34-CB1424	48 lbs	WC54-CB1424	34 lbs
14" x 30"	WC14-CB1430	14 lbs	WC34-CB1430	28 lbs	WC54-CB1430	42 lbs
14" x 36"	WC14-CB1436	15 lbs	WC34-CB1436	30 lbs	WC54-CB1436	45 lbs
14" x 42"	WC14-CB1442	17 lbs	WC34-CB1442	34 lbs	WC54-CB1442	51 lbs
14" x 48"	WC14-CB1448	18 lbs	WC34-CB1448	36 lbs	WC54-CB1448	54 lbs
14" x 54"	WC14-CB1454	19 lbs	WC34-CB1454	38 lbs	WC54-CB1454	57 lbs
14" x 60"	WC14-CB1460	21 lbs	WC34-CB1460	42 lbs	WC54-CB1460	63 lbs
14" x 72"	WC14-CB1472	24 lbs	WC34-CB1472	48 lbs	WC54-CB1472	72 lbs
18" x 24"	WC14-CB1824	15 lbs	WC34-CB1824	30 lbs	WC54-CB1824	45 lbs
18" x 30"	WC14-CB1830	16 lbs	WC34-CB1830	32 lbs	WC54-CB1830	48 lbs
18" x 36"	WC14-CB1836	18 lbs	WC34-CB1836	36 lbs	WC54-CB1836	54 lbs
18" x 42"	WC14-CB1842	19 lbs	WC34-CB1842	38 lbs	WC54-CB1842	57 lbs
18" x 48"	WC14-CB1848	22 lbs	WC34-CB1848	44 lbs	WC54-CB1848	66 lbs
18" x 54"	WC14-CB1854	23 lbs	WC34-CB1854	46 lbs	WC54-CB1854	69 lbs
18" x 60"	WC14-CB1860	25 lbs	WC34-CB1860	50 lbs	WC54-CB1860	75 lbs
18" x 72"	WC14-CB1872	28 lbs	WC34-CB1872	56 lbs	WC54-CB1872	84 lbs
21" x 24"	WC14-CB2124	16 lbs	WC34-CB2124	32 lbs	WC54-CB2124	48 lbs
21" x 30"	WC14-CB2130	17 lbs	WC34-CB2130	34 lbs	WC54-CB2130	51 lbs
21" x 36"	WC14-CB2136	19 lbs	WC34-CB2136	38 lbs	WC54-CB2136	57 lbs
21" x 42"	WC14-CB2142	20 lbs	WC34-CB2142	40 lbs	WC54-CB2142	60 lbs
21" x 48"	WC14-CB2148	22 lbs	WC34-CB2148	44 lbs	WC54-CB2148	66 lbs
21" x 54"	WC14-CB2154	24 lbs	WC34-CB2154	48 lbs	WC54-CB2154	72 lbs
21" x 60"	WC14-CB2160	26 lbs	WC34-CB2160	52 lbs	WC54-CB2160	78 lbs
21" x 72"	WC14-CB2172	32 lbs	WC34-CB2172	64 lbs	WC54-CB2172	96 lbs
24" x 24"	WC14-CB2424	18 lbs	WC34-CB2424	36 lbs	WC54-CB2424	54 lbs
24" x 30"	WC14-CB2430	20 lbs	WC34-CB2430	40 lbs	WC54-CB2430	60 lbs
24" x 36"	WC14-CB2436	22 lbs	WC34-CB2436	44 lbs	WC54-CB2436	66 lbs
24" x 42"	WC14-CB2442	24 lbs	WC34-CB2442	48 lbs	WC54-CB2442	72 lbs
24" x 48"	WC14-CB2448	25 lbs	WC34-CB2448	50 lbs	WC54-CB2448	59 lbs
24" x 54"	WC14-CB2454	27 lbs	WC34-CB2454	54 lbs	WC54-CB2454	81 lbs
24" x 60"	WC14-CB2460	30 lbs	WC34-CB2460	60 lbs	WC54-CB2460	90 lbs
24" x 72"	WC14-CB2472	35 lbs	WC34-CB2472	70 lbs	WC54-CB2472	105 lbs

Mobile Dunnage Platform Racks



Units can be used for moving case goods and other heavy items for cleaning, warehouse and stock room applications. Non-marking casters add flexibility. **Finish:** Gray Epoxy

Each unit consists of:

- 4 - 6" posts
- 1 - 3 sided frame
- 1 - dunnage shelf
- 4 - 5" swivel thermoplastic resin casters, 2 with brakes
- 4 - donut bumpers

Up to **1,200 lb.**  
MOBILE LOAD CAPACITY

GRAY MODEL NO.	DIMENSIONS W" x L" x H"	SHIP WGT
M18246DGY	18" x 24" x 12"	36 lbs
M18306DGY	18" x 30" x 12"	40 lbs
M18366DGY	18" x 36" x 12"	44 lbs
M18426DGY	18" x 42" x 12"	48 lbs
M18486DGY	18" x 48" x 12"	52 lbs
M18606DGY	18" x 60" x 12"	59 lbs
M24246DGY	24" x 24" x 12"	39 lbs
M24306DGY	24" x 30" x 12"	44 lbs
M24366DGY	24" x 36" x 12"	48 lbs
M24426DGY	24" x 42" x 12"	53 lbs
M24486DGY	24" x 48" x 12"	55 lbs
M24606DGY	24" x 60" x 12"	63 lbs



M18366DGY

Modular Dunnage Racks



Ideal for extreme load capacities (up to 1,300-1,600 lb.). Includes tubular 1" square frame super structure and removable wire top mat. **Finish:** Gray Epoxy

Each unit consists of:

- 4 - 14" posts
- 1 - 3 sided frame
- 1 - dunnage shelf

Up to **1,300-1,600 lb.**  
MOBILE LOAD CAPACITY

GRAY MODEL NO.	DIMENSIONS W" x L" x H"	SHIP WGT
182414DGY	18" x 24" x 14"	22 lbs
183014DGY	18" x 30" x 14"	26 lbs
183614DGY	18" x 36" x 14"	30 lbs
184214DGY	18" x 42" x 14"	34 lbs
184814DGY	18" x 48" x 14"	38 lbs
186014DGY	18" x 60" x 14"	45 lbs
242414DGY	24" x 24" x 14"	25 lbs
243014DGY	24" x 30" x 14"	30 lbs
243614DGY	24" x 36" x 14"	34 lbs
244214DGY	24" x 42" x 14"	39 lbs
244814DGY	24" x 48" x 14"	41 lbs
246014DGY	24" x 60" x 14"	49 lbs



183614DGY



Tank & Beverage Container Racks



Represents a cost effective way to keep containers off the floor for cleanliness. This unit is an effective way to tidy up and increase available storage capacity. Used frequently in cafeterias and warehouse applications. **Finish:** Gray Epoxy

Each 1 Tier unit consists of:

- 4 - 34" posts
- 1 - 3 sided frame
- 1 - dunnage shelf

Up to **1,300-1,600 lb.**  
MOBILE LOAD CAPACITY

Each 2 Tier unit consists of:

- 4 - 54" posts
- 2 - 3 sided frames
- 2 - dunnage shelves

Up to **2,600-3,200 lb.**  
MOBILE LOAD CAPACITY

WEIGHT CAPACITY BASED ON EVEN LOAD DISTRIBUTION PER SHELF

GRAY MODEL NO.	DIMENSIONS W" x L" x H"	SHIP WGT
<b>1 Tier</b>		
182434DGY	18" x 24" x 34"	26 lbs
183034DGY	18" x 30" x 34"	30 lbs
183634DGY	18" x 36" x 34"	34 lbs
184234DGY	18" x 42" x 34"	38 lbs
184834DGY	18" x 48" x 34"	42 lbs
186034DGY	18" x 60" x 34"	49 lbs
242434DGY	24" x 24" x 34"	29 lbs
243034DGY	24" x 30" x 34"	34 lbs
243634DGY	24" x 36" x 34"	38 lbs
244234DGY	24" x 42" x 34"	43 lbs
244834DGY	24" x 48" x 34"	45 lbs
246034DGY	24" x 60" x 34"	55 lbs
<b>2 Tier</b>		
182454DGY	18" x 24" x 54"	48 lbs
183054DGY	18" x 30" x 54"	56 lbs
183654DGY	18" x 36" x 54"	64 lbs
184254DGY	18" x 42" x 54"	72 lbs
184854DGY	18" x 48" x 54"	80 lbs
186054DGY	18" x 60" x 54"	94 lbs
242454DGY	24" x 24" x 54"	54 lbs
243054DGY	24" x 30" x 54"	34 lbs
243654DGY	24" x 36" x 54"	72 lbs
244254DGY	24" x 42" x 54"	82 lbs
244854DGY	24" x 48" x 54"	86 lbs
246054DGY	24" x 60" x 54"	106 lbs



183654DGY

Shelf Platform Racks



Represents an ergonomic solution for keeping case goods off the floor. Platforms are often used at workstations and prep storage areas. **Finish:** Chrome and Proform Green Epoxy

Each unit consists of:

- 4 - 14" posts
- 1 - shelf

Up to **600-800 lb.**  
MOBILE LOAD CAPACITY

MAXIMUM STORAGE SPACE

NEW

CHROME MODEL NO.	PROFORM MODEL NO.	DIMENSIONS W" x L" x H"	SHIP WGT
183614PC	183614PP	18" x 36" x 14"	14 lbs
184814PC	184814PP	18" x 48" x 14"	18 lbs
186014PC	186014PP	18" x 60" x 14"	21 lbs
243614PC	243614PP	24" x 36" x 14"	17 lbs
244814PC	244814PP	24" x 48" x 14"	20 lbs
246014PC	246014PP	24" x 60" x 14"	25 lbs



183614PC



MODEL NO.	DIMENSIONS W" x L" x H"	LOAD CAPACITY	SHIP WGT
<b>Ventilated Top</b>			
362412DPP	24" x 36" x 12"	500 lbs	13 lbs
363612DPP	36" x 36" x 12"	750 lbs	22 lbs
482412DPP	24" x 48" x 12"	700 lbs	19 lbs
662412DPP	24" x 66" x 12"	1,000 lbs	23 lbs
663612DPP	36" x 66" x 12"	1,500 lbs	37 lbs
962412DPP	24" x 96" x 12"	1,400 lbs	34 lbs
963612DPP	36" x 96" x 12"	2,000 lbs	53 lbs
<b>Solid Top</b>			
362412DPS	24" x 36" x 12"	700 lbs	17 lbs
363612DPS	36" x 36" x 12"	1,000 lbs	26 lbs
482412DPS	24" x 48" x 12"	900 lbs	21 lbs
662412DPS	24" x 66" x 12"	1,400 lbs	28 lbs
663612DPS	36" x 66" x 12"	1,900 lbs	49 lbs
962412DPS	24" x 96" x 12"	1,800 lbs	41 lbs
963612DPS	36" x 96" x 12"	2,700 lbs	64 lbs

**Polymer Dunnage Racks**



Our Dunnage Racks are as portable as they are versatile. Made from lightweight, heavy-duty high density polyethylene, these are the perfect match for wet or chemically intense manufacturing environments. A simple snap together design makes it a breeze to raise finished goods and raw materials off the ground and away from moisture, dirt and traffic. When it comes to cleanup time, just sweep underneath! We offer the largest commercially available sizes in a high-capacity, low-cost dunnage solution that lets you reset and move workstations as often as you see fit. Plus, the grid-top design simplifies working with fluids and bagged goods because any spilled items will flow through the surface to the floor below.



**Expandable EZ Lock Platform Rack & Pallet**



Quantum's EZ Lock platform and pallet allows you to customize your storage space in seconds. Its patented interlocking design allows true flexibility in building the exact size pallet or platform you need. Using 12" x 40" footprints, each unit locks together making this an all-purpose storage, moving, and shipping solution. Manufactured of recycled high density polyethylene, the vented deck is freezer safe and chemical resistant. Its one piece body design and structure allows for a 4 way forklift and hand truck entry, and it meets GMA industry standards. Enhances any 5S Lean initiative. Withstands temperatures from -30°F – 200°F and offers up to 2,500 lb. load capacity when connected. Once built, the structure will maintain its dimensions with no sagging or stretching. Plastic will not absorb any liquids or chemicals and is resistant to insect infestation. Perfect for use in hospitals, pharmacies, clean rooms, food and beverage areas, manufacturing environments, and supermarket and grocery store back rooms.

**EASILY STORE SUPPLIES AND MATERIALS OFF THE GROUND**

Available in: ● Black

MODEL NO.	DIMENSIONS W" x L" x H"	CTN QTY	SHIP WGT
EL-12406	12" x 40" x 6"	1 Pair (2 Pieces)	14 lbs

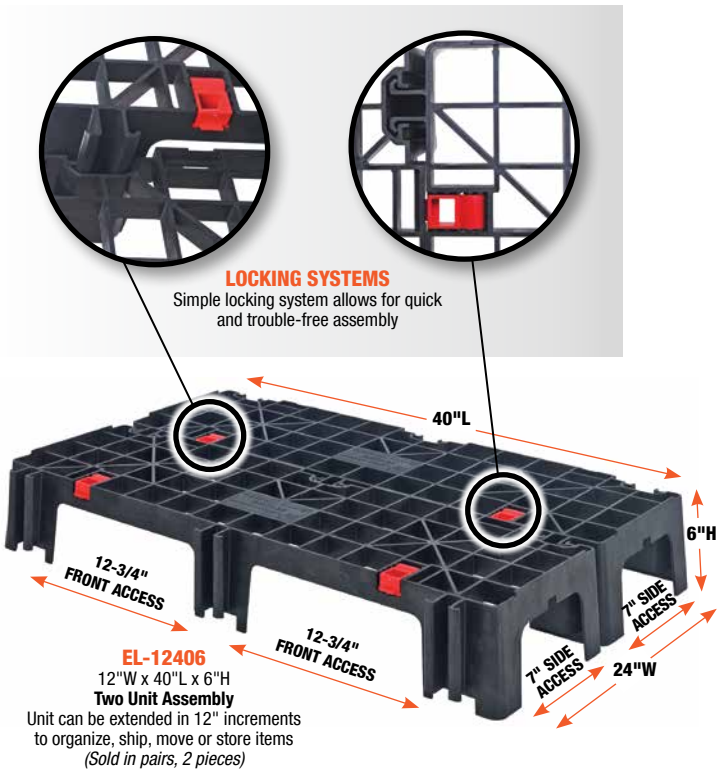

**QUICK AND TROUBLE-FREE ASSEMBLY UP TO 2,500 LB. LOAD CAPACITY**



**STACKABLE FOR EASY STORAGE**

# 3 FINISHES AVAILABLE



**1" PERIMETER AROUND DROP MAT SHELVES**



## Retaining Drop Mat Cantilever Shelf

Retaining Drop Mat Cantilever Shelves provide a 1" perimeter around the shelf. Space-efficient and easy to install. Up to 150 lbs load capacity. Unit will require taller rear posts to accommodate these shelves. **Finishes:** Proform Green, Gray and Black Epoxy

**NEW**  
1236RCSP  
Proform Green Epoxy Finish



MODEL NO.	DIMENSIONS W" x L"	SHIP WGT
<b>Proform Green Epoxy Cantilever Shelves</b>		
1224RCSP	12" x 24"	5 lbs
1230RCSP	12" x 30"	6 lbs
1236RCSP	12" x 36"	7 lbs
1242RCSP	12" x 42"	8 lbs
1248RCSP	12" x 48"	9 lbs
1260RCSP	12" x 60"	11 lbs
<b>Gray Epoxy Cantilever Shelves</b>		
1224RCSGY	12" x 24"	5 lbs
1230RCSGY	12" x 30"	6 lbs
1236RCSGY	12" x 36"	7 lbs
1242RCSGY	12" x 42"	8 lbs
1248RCSGY	12" x 48"	9 lbs
1260RCSGY	12" x 60"	11 lbs
<b>Black Epoxy Cantilever Shelves</b>		
1224RCSBK	12" x 24"	5 lbs
1230RCSBK	12" x 30"	6 lbs
1236RCSBK	12" x 36"	7 lbs
1242RCSBK	12" x 42"	8 lbs
1248RCSBK	12" x 48"	9 lbs
1260RCSBK	12" x 60"	11 lbs

**NEW**  
1236RCSGY  
Gray Epoxy Finish



**NEW**  
1236RCSBK  
Black Epoxy Finish



**Up to 150 lb. LOAD CAPACITY PER SHELF**

**MOUNTS ON UNIT'S BACK POSTS**

## Dunnage Shelves



Dunnage shelves are constructed of 1" square tubular steel with removable wire decking. Utilized in extreme load applications. Up to 1,300-1,600 lb. load capacity depending of shelf length. **Finishes:** Blue Endurance or Gray Epoxy - Excellent for high humidity or corrosive applications and is fortified with an antimicrobial agent.

BLUE ENDURANCE MODEL NO.	GRAY MODEL NO.	DIMENSIONS W" x L"	SHIP WGT
-	1824DSGY	18" x 24"	14 lbs
-	1830DSGY	18" x 30"	18 lbs
1836DS	1836DSGY	18" x 36"	21 lbs
-	1842DSGY	18" x 42"	25 lbs
1848DS	1848DSGY	18" x 48"	28 lbs
1860DS	1860DSGY	18" x 60"	34 lbs
-	2424DSGY	24" x 24"	16 lbs
-	2430DSGY	24" x 30"	20 lbs
2436DS	2436DSGY	24" x 36"	24 lbs
-	2442DSGY	24" x 42"	28 lbs
-	2448DSGY	24" x 48"	30 lbs
2460DS	2460DSGY	24" x 60"	37 lbs

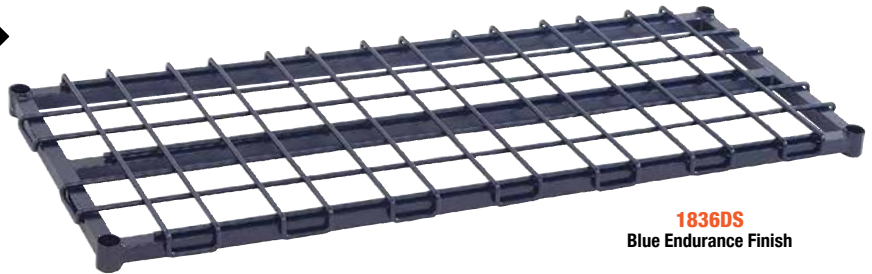

1836DS  
Blue Endurance Finish

## HEAVY-DUTY



1836DSGY  
Gray Epoxy Finish

**Up to 1,300-1,600 lb. LOAD CAPACITY PER SHELF**

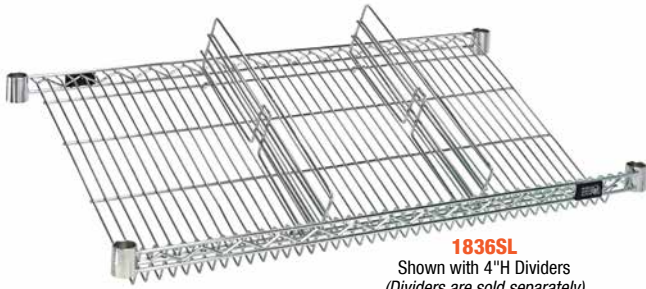

**1836SL**  
Shown with 4"H Dividers  
(Dividers are sold separately)

**Slanted Shelves**



Designed with a 25° slant to add structure to various applications and retain products. Perfect angle for gravity flow as well as bin storage. **Finish:** Chrome

CHROME MODEL NO.	DIMENSIONS W" x L"	SHIP WGT	DIVIDER MODEL NO.
<b>1836SL</b>	18" x 36"	7 lbs	<b>DIV18SL</b>
<b>1848SL</b>	18" x 48"	8 lbs	<b>DIV18SL</b>
<b>2436SL</b>	24" x 36"	8 lbs	<b>DIV24SL</b>
<b>2448SL</b>	24" x 48"	9 lbs	<b>DIV24SL</b>
<b>2472SL</b>	24" x 72"	12 lbs	<b>DIV24SL</b>

**NEW SIZES**

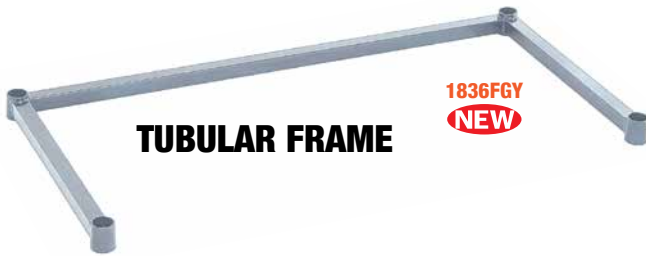

**TUBULAR FRAME**

**1836FGY**  
**NEW**

**Tubular 3 Sided Frames**



Constructed of 1" square tubing, frame is designed for added structure to the perimeter of a dunnage or shelving unit. **Finish:** Gray Epoxy

GRAY MODEL NO.	DIMENSIONS W" x L"	SHIP WGT
<b>1824FGY</b> <b>NEW</b>	18" x 24"	4 lbs
<b>1830FGY</b> <b>NEW</b>	18" x 30"	4 lbs
<b>1836FGY</b>	18" x 36"	5 lbs
<b>1842FGY</b> <b>NEW</b>	18" x 42"	5 lbs
<b>1848FGY</b>	18" x 48"	6 lbs
<b>1860FGY</b>	18" x 60"	7 lbs
<b>2424FGY</b> <b>NEW</b>	24" x 24"	5 lbs
<b>2430FGY</b> <b>NEW</b>	24" x 30"	6 lbs
<b>2436FGY</b>	24" x 36"	6 lbs
<b>2442FGY</b> <b>NEW</b>	24" x 42"	7 lbs
<b>2448FGY</b>	24" x 48"	7 lbs
<b>2460FGY</b>	24" x 60"	10 lbs

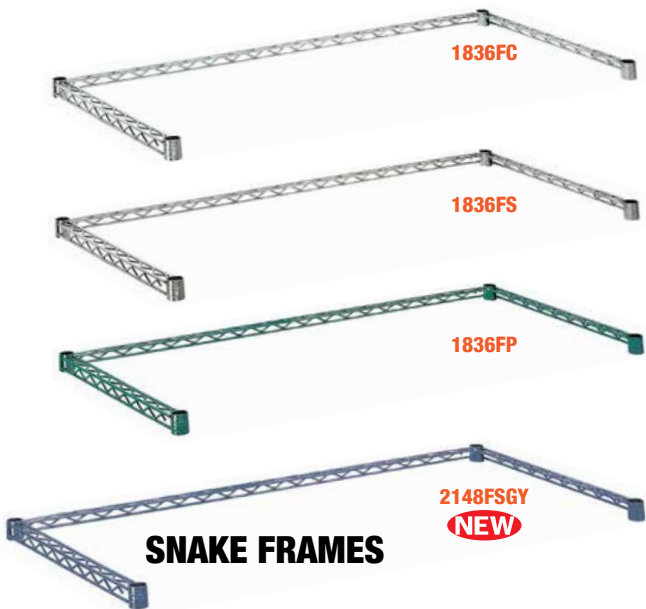

**SNAKE FRAMES**

**1836FC**

**1836FS**

**1836FP**

**2148FSGY**  
**NEW**

**Wire 3 Sided Snake Frames**



Designed to add structure to various applications and retain products. **Finishes:** Chrome, 304 Stainless Steel, Proform Green Epoxy and Gray Epoxy

CHROME	STAINLESS	PROFORM	GRAY	DIMENSIONS W" x L"	SHIP WGT
MODEL NO.	MODEL NO.	MODEL NO.	MODEL NO.		
<b>1836FC</b>	<b>1836FS</b>	<b>1836FP</b>	-	18" x 36"	6 lbs
<b>1848FC</b>	<b>1848FS</b>	<b>1848FP</b>	-	18" x 48"	7 lbs
<b>1860FC</b>	<b>1860FS</b>	<b>1860FP</b>	-	18" x 60"	8 lbs
-	-	-	<b>2148FSGY</b> <b>NEW</b>	21" x 48"	8 lbs
-	-	-	<b>2160FSGY</b> <b>NEW</b>	21" x 60"	9 lbs
<b>2436FC</b>	<b>2436FS</b>	<b>2436FP</b>	-	24" x 36"	8 lbs
<b>2448FC</b>	<b>2448FS</b>	<b>2448FP</b>	-	24" x 48"	9 lbs
<b>2460FC</b>	<b>2460FS</b>	<b>2460FP</b>	-	24" x 60"	10 lbs

**NEW SIZES**

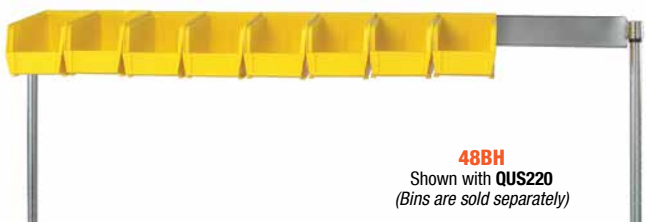

**48BH**  
Shown with QUS220  
(Bins are sold separately)

**Bin Rail Holders**



Creates a more functional work area with the bin rail which allows you to adapt bins to your shelving unit. Bin rail holder adjusts on 1" increments. **Finish:** Chrome

MODEL NO.	DESCRIPTION	SHIP WGT
<b>24BH</b> <b>NEW</b>	One 24" Bin Holder	3 lbs
<b>30BH</b> <b>NEW</b>	One 30" Bin Holder	4 lbs
<b>36BH</b>	One 36" Bin Holder	5 lbs
<b>48BH</b>	One 48" Bin Holder	7 lbs
<b>60BH</b>	One 60" Bin Holder	9 lbs

MODEL NO.	QUS 210	QUS 220	QUS 221	QUS 224	QUS 230
<b>Quantity of Ultra Bins to Fit Bin Rail Holders</b>					
<b>24BH</b>	5	5	5	3	3
<b>30BH</b>	6	6	6	4	4
<b>36BH</b>	8	8	5	8	6
<b>48BH</b>	11	11	7	11	8
<b>60BH</b>	14	14	9	14	10

See pg. 5 for bin dimensions

**NEW SIZES**

Modular Trays



Heavy-duty 18" x 26" white trays are NSF approved and can be used in any application. Perimeter ends are reinforced for additional strength. 20" x 26" size offers a deep stacking tray. Both tray sizes are available in ESD material complying to ANSI/ESD standards for the use in PC board assembly and handling. All trays are manufactured from fiberglass reinforced thermoset material, allowing up to 200 lb. weight capacity when evenly distributed. Quantum's modular trays will withstand temperatures of -40°F to +350°F. 18" x 26" Trays available in White and ESD, 20" x 26" Trays are available in Gray, White and ESD.

Available in: ● Gray ○ White ● Black (ESD)

MODEL NO.	DIMENSIONS W" x L" x H"	SHIP WGT
<b>18" x 26" - Trays</b>		
1826TR	18" x 26" x 1-1/8" White Tray	4 lbs
1826ESD	18" x 26" x 1-1/8" Black ESD Tray	4 lbs
<b>20" x 26" - Stackable Trays</b>		
2026TRGY	20" x 26" x 1-1/2" Gray Tray	5 lbs
2026TRWT	20" x 26" x 1-1/2" White Tray	5 lbs
2026ESD	20" x 26" x 1-1/2" Black ESD Tray	5 lbs



Tray Slides



Efficiently utilize space between shelves using standard trays and/or bins.

- Available in 18" and 24" depths, overall height 23"
- Accommodates up to 10 trays

MODEL NO.	DESCRIPTION	SHIP WGT
<b>Tray Slide</b>		
TS18C	18" Tray Slide Set	10 lbs
TS24C	24" Tray Slide Set	11 lbs



Up to 200 lb. LOAD CAPACITY PER TRAY

Modular Tray Carts

Tray Carts are offered in half size and full size units, designed to handle work in process. ESD trays can be used on tray cart for conductive applications with the addition of conductive plastic split sleeves (WR-SSCO) and a drag chain (ESD-DC). Optional Tray Stop prevents trays from falling out. **Cart Finish:** Chrome

MODEL NO.	DIMENSIONS W" x L" x H"	SHIP NO. OF TRAY WGT	TRAY MODEL NO.	TRAY STOP MODEL NO.
<b>39"H - Side Load Tray Cart</b>				
TC-19	18" x 30" x 39"	45 lbs 19	1826ESD 1826TR	TS32C
<b>69"H - Side Load Tray Carts</b>				
TC-20 <b>NEW</b>	18" x 30" x 69"	72 lbs 20	1826ESD 1826TR	TS62C
TC-39	18" x 30" x 69"	74 lbs 39	1826ESD 1826TR	TS62C
TC-31	21" x 30" x 69"	68 lbs 31	2026ESD 2026TR	TS62C
<b>69"H - End Load Tray Cart</b>				
TC-EL38	21-3/4" x 27" x 69"	74 lbs 38	1826ESD 1826TR	TS62C

Trays are sold separately



WR-00CO Conductive Casters  
4 swivel  
- 2 brakes  
- 2 non-brakes



Conductive Options



WR-SSCO Plastic Conductive Split Sleeve





**UB10**  
Utility Basket

An additional storage or display area outside the perimeter of the shelf. Measures 18-7/8"W x 11-1/4"D x 7-5/8"H.

Finish: Chrome

**Up to 25 lb.**  
LOAD CAPACITY

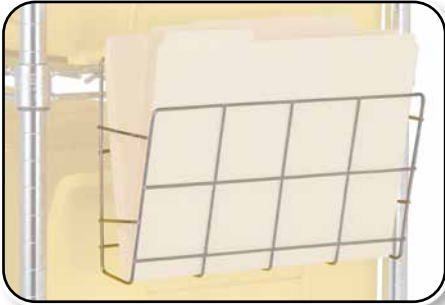

**DH8**

Document Holder

Provides an effective way to secure documents or folders. Measures 12-3/8"W x 2"D x 8-5/8"H. Finish: Chrome

**Up to 25 lb.**  
LOAD CAPACITY

**Shelf Inlay Mats**

An economical solution to convert a wire shelf to a solid surface preventing items from falling through. White shelf inlay mat is easily removable for cleaning. Manufactured of polyethylene, .5 mm thickness.

MODEL NO.	DESCRIPTION	SHIP WGT
1836SM	One 18" x 36" Inlay Mat	1 lb
1848SM	One 18" x 48" Inlay Mat	2 lbs
1860SM	One 18" x 60" Inlay Mat	2 lbs
1872SM	One 18" x 72" Inlay Mat	2 lbs
2436SM	One 24" x 36" Inlay Mat	2 lbs
2448SM	One 24" x 48" Inlay Mat	2 lbs
2460SM	One 24" x 60" Inlay Mat	2 lbs
2472SM	One 24" x 72" Inlay Mat	3 lbs

**CUSTOM SIZES AVAILABLE**

call for details



**EASY TO CLEAN**  
CREATES SPILL-SAFE SURFACE

**Wire Shelf Covers**

**NSF NEW**

- Crystal clear and very sturdy
- Converts wire shelf to a solid shelf
- Provides a spill-safe surface so that no liquid will fall through the wire
- Wire label holders can still be placed on the wire shelf and the cover's edge will fit over the front of the label holder
- Withstands temperatures from -20°F up to 170°F



MODEL NO.	DESCRIPTION	SHIP WGT
1836COV	One 18" x 36" Shelf Cover	3 lbs
1848COV	One 18" x 48" Shelf Cover	4 lbs
1860COV	One 18" x 60" Shelf Cover	4 lbs
1872COV	One 18" x 72" Shelf Cover	5 lbs
2436COV	One 24" x 36" Shelf Cover	4 lbs
2448COV	One 24" x 48" Shelf Cover	5 lbs
2460COV	One 24" x 60" Shelf Cover	6 lbs
2472COV	One 24" x 72" Shelf Cover	6 lbs

**Polymer Shelf Label Holder**

**NEW**

MODEL NO.	DESCRIPTION	SHIP WGT
<b>Clear Label Holders</b>		
ULH3C	3" Clear Label Holder	1 lb
ULH33C	33" Clear Label Holder Fits 36" Shelf	1 lb
ULH45C	45" Clear Label Holder Fits 48" Shelf	1 lb
ULH57C	57" Clear Label Holder Fits 60" Shelf	1 lb
ULH69C	69" Clear Label Holder Fits 72" Shelf	1 lb



Label Holders can also be used on Wire Shelves

**Post Label Holders**

New post label holders come in two sizes and allow for easy identification of aisles/rows as well as of wire cart contents. Attach to standard 1" diameter posts. Each package includes 12 clear holders and corresponding printer friendly sheet labels.

MODEL NO.	DIMENSIONS W" x L"	PKG QTY	SHIP WGT
PLH1X6C	1" x 6"	12 pcs	1 lb
PLH2X4C	2" x 4"	12 pcs	1 lb



**EASY IDENTIFICATION OF AISLES/ROWS CONTENTS**

**Modular Enclosure Panels**

**NEW FINISH**

Are easily adaptable to standard shelving units to create a secured storage area.

- Panels are fabricated from 6 gauge wire on 3" x 3" squares
- Modular enclosure panels work with four shelf depths: 14", 18", 21" and 24" and three heights: 63", 74" and 86"
- One modular enclosure panel is needed for each side and two or three panels are needed for the back
- New EP-CLIP hardware package allows enclosure panels to be fastened tight to the shelves to help eliminate any rattling noise while in transit. One package needed per enclosure panel.

CHROME	STAINLESS STEEL	PROFORM GREEN EPOXY <small>(NEW)</small>	Add -CUT to Model No. for use with bottom solid shelf	Ex. EP126-CUT
MODEL NO.	MODEL NO.	MODEL NO.	DESCRIPTION	SHIP WGT
EP126	EP126S	EP126P	One 12" x 62" Panel	5 lbs
EP166	EP166S	EP166P	One 16" x 62" Panel	6 lbs
EP196	EP196S	EP196P	One 19" x 62" Panel	7 lbs
EP226	EP226S	EP226P	One 22" x 62" Panel	8 lbs
EP127	EP127S	EP127P	One 12" x 73" Panel	6 lbs
EP167	EP167S	EP167P	One 16" x 73" Panel	7 lbs
EP197	EP197S	EP197P	One 19" x 73" Panel	8 lbs
EP227	EP227S	EP227P	One 22" x 73" Panel	9 lbs
EP128	EP128S	EP128P	One 12" x 84" Panel	7 lbs
EP168	EP168S	EP168P	One 16" x 84" Panel	8 lbs
EP198	EP198S	EP198P	One 19" x 84" Panel	9 lbs
EP228	EP228S	EP228P	One 22" x 84" Panel	10 lbs



**MOBILE CART SHOWN WITH 4 ENCLOSURE PANELS. MOBILE ENCLOSURE CARTS AVAILABLE**

See pg. 128

- Holds up to 25 lb. weight capacity evenly distributed

**Single and Double Drawer Slides**

Compliment any system with specialized areas for storage which allow bins and trays to be suspended between shelves. Single bin slide mounts 18", 21" and 24" shelves. Double bin slide adapts to 24" shelves only. (Bins sold separately) *Finish:* Chrome

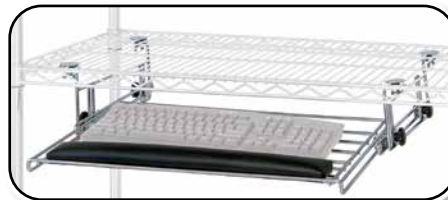

**KEYBD**

**Keyboard Shelf**

Mounts under any size wire shelf and accepts keyboards up to 21"W x 11"D. Has a 6" height adjustment. Measures 25-1/4"W x 15"D x 4-1/4"H

*Finish:* Chrome

MODEL NO.	DESCRIPTION	SHIP WGT
DS18-24	Single Bin Design	2 lbs
DDS-24	Double Bin Design	4 lbs



DS18-24



**Modular Dolly Frames**

DB1836S-PT

Dolly Frames allow standard shelving units to be converted to heavy-duty transport trucks. Frames are fabricated from heavy gauge steel. Bumpers are attached to each corner to protect walls and help cushion impact. *Finishes:* Chrome and Stainless Steel

CHROME	STAINLESS STEEL	DIMENSIONS W" x L"	SHIP WGT
Dolly Frame Only			
DB1836C	DB1836S	18" x 36"	10 lbs
DB1848C	DB1848S	18" x 48"	12 lbs
DB1860C	DB1860S	18" x 60"	14 lbs
DB2436C	DB2436S	24" x 36"	13 lbs
DB2448C	DB2448S	24" x 48"	15 lbs
DB2460C	DB2460S	24" x 60"	18 lbs
Dolly Kit - Includes 4 Swivel Plate Casters, 2 with Brake			
DB1836C-PT	DB1836S-PT	18" x 36"	22 lbs
DB1848C-PT	DB1848S-PT	18" x 48"	24 lbs
DB1860C-PT	DB1860S-PT	18" x 60"	26 lbs
DB2436C-PT	DB2436S-PT	24" x 36"	25 lbs
DB2448C-PT	DB2448S-PT	24" x 48"	27 lbs
DB2460C-PT	DB2460S-PT	24" x 60"	30 lbs

**CHOOSE FROM ONE BIN/TRAY DESIGN OR TWO BIN/TRAY DESIGN**



DDS24

**Hang Rails**

HB18C

CHROME	STAINLESS STEEL	DESCRIPTION	SHIP WGT
HB14C	-	One 14" Hang Rail	2 lbs
HB18C	HB18S	One 18" Hang Rail	3 lbs
HB24C	HB24S	One 24" Hang Rail	4 lbs
HB36C	HB36S	One 36" Hang Rail	5 lbs
HB48C	HB48S	One 48" Hang Rail	6 lbs
HB60C	HB60S	One 60" Hang Rail	7 lbs

**Hang Bars**

- Holds up to 75 lbs. weight capacity evenly distributed

CHROME	STAINLESS STEEL	DESCRIPTION	SHIP WGT
Intermediate			
GR24	-	One 24" Chrome Hang Bar	2 lbs
Full Length			
GR36	GR36S	One 36" Hang Bar	3 lbs
GR48	GR48S	One 48" Hang Bar	4 lbs
GR60	GR60S	One 60" Hang Bar	5 lbs
-	GR72S	One 72" Stainless Steel Hang Bar	6 lbs



GR24



GR36, GR48, GR60

### Side and Back Ledges

Ledges are 4"H and act as a perimeter to retain shelf items and prevent anything from falling off. To order a Proform Green, Gray or Black Epoxy finish, add **P, GY** or **BK** right after chrome model no. prefix (i.e. *SL12P, SL12GY* or *SL12BK*). **Finishes:** Chrome, Stainless Steel, Proform Green, Gray and Black Epoxy

CHROME	STAINLESS STEEL	AVAILABLE EPOXY			DESCRIPTION	SHIP WGT
MODEL NO.	MODEL NO.	P	GY	BK		
<b>4"H - Side Ledges</b>						
SL12	SL12S	Y	Y	Y	12" Side Ledge	1 lb
SL14	SL14S	Y	Y	Y	14" Side Ledge	1 lb
SL18	SL18S	Y	Y	Y	18" Side Ledge	1 lb
SL21	SL21S	Y	Y	Y	21" Side Ledge	2 lbs
SL24	SL24S	Y	Y	Y	24" Side Ledge	2 lbs
SL30	SL30S	Y	Y	Y	30" Side/Back Ledge	2 lbs
<b>4"H - Back Ledges</b>						
BL36	BL36S	Y	Y	Y	36" Back/Side Ledge	3 lbs
BL42	BL42S	Y	Y	Y	42" Back Ledge	3 lbs
BL48	BL48S	Y	Y	Y	48" Back Ledge	3 lbs
BL54	BL54S	Y	Y	Y	54" Back Ledge	4 lbs
BL60	BL60S	Y	Y	Y	60" Back Ledge	5 lbs
BL72	BL72S	Y	Y	Y	72" Back Ledge	6 lbs

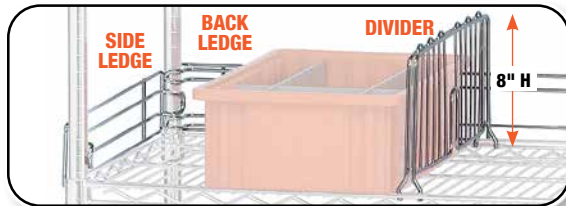

### Dividers

**NEW SIZES**

Dividers are 8"H unless specified and are available in 7 depths to be used with all shelves. To order a Proform Green, Gray or Black Epoxy finish, add **P, GY** or **BK** right after chrome model no. prefix (i.e. *DIV12P, DIV12GY* or *DIV12BK*). **Finishes:** Chrome, Stainless Steel, Proform Green, Gray and Black Epoxy

CHROME	STAINLESS STEEL	AVAILABLE EPOXY			DESCRIPTION	SHIP WGT
MODEL NO.	MODEL NO.	P	GY	BK		
<b>Dividers</b>						
DIV12	DIV12S	Y	Y	Y	One 12" Divider	2 lbs
DIV14	DIV14S	Y	Y	Y	One 14" Divider	2 lbs
DIV18	DIV18S	Y	Y	Y	One 18" Divider	2 lbs
DIV21	DIV21S	Y	Y	Y	One 21" Divider	3 lbs
DIV24	DIV24S	Y	Y	Y	One 24" Divider	3 lbs
<b>NEW</b> DIV24X3SW**	-	N	N	N	One 24" x 3.6" Divider	1 lb
<b>NEW</b> DIV24X6	-	N	N	N	One 24" x 6" Divider	1 lb
<b>NEW</b> DIV24X21*	-	N	Y	N	One 24" x 21" Divider	5 lbs
DIV30	DIV30S	Y	Y	Y	One 30" Divider	4 lbs
DIV36	DIV36S	Y	Y	Y	One 36" Divider	4 lbs

\*Only available in Gray Epoxy finish  
\*\*Single wire design

### Wire Carton Dividers

Quantum's new wire carton dividers are the ideal storage tool to maintain and organize your boxes. Available for 18" and 24" shelf depths, the dividers fix in place and provide firm and convenient storage to your warehouse and workplace. Two convenient heights to choose from: 14" or 20-1/2". **Finish:** Chrome

MODEL NO.	DESCRIPTION	SHIP WGT
WCSD-1814	18" x 14" Divider	3 lbs
WCSD-1820	18" x 20-1/2" Divider	3 lbs
WCSD-2414	24" x 14" Divider	3 lbs
WCSD-2420	24" x 20-1/2" Divider	4 lbs

### Push Handles

Comfortable grip design. Five widths available enabling easy movement of any mobile unit. To order a Proform Green, Gray or Black Epoxy finish, add **P, GY** or **BK** right after chrome model no. prefix (i.e. *PH18P, PH18GY* or *PH18BK*). **Finishes:** Chrome, Stainless Steel, Proform Green, Gray and Black Epoxy

CHROME	STAINLESS STEEL	AVAILABLE EPOXY			DESCRIPTION	SHIP WGT
MODEL NO.	MODEL NO.	P	GY	BK		
PH18	PH18S	Y	Y	Y	One 18" Push Handle	2 lbs
PH21	PH21S	Y	Y	N	One 21" Push Handle	3 lbs
PH24	PH24S	Y	Y	Y	One 24" Push Handle	3 lbs
PH30	-	N	N	N	One 30" Push Handle	3 lbs
PH36	PH36S	N	N	N	One 36" Push Handle	3 lbs



PH18

### U-Handles

Build your own special size utility cart with three different width choices: 18", 21" or 24". Overall height 32", not including casters. To order a Proform Green, Gray or Black Epoxy finish, add **P, GY** or **BK** right after chrome model no. prefix (i.e. *UH18P, UH18GY* or *UH18BK*). **Finishes:** Chrome, Stainless Steel, Proform Green, Gray and Black Epoxy

CHROME	STAINLESS STEEL	AVAILABLE EPOXY			DESCRIPTION	SHIP WGT
MODEL NO.	MODEL NO.	P	GY	BK		
UH18	UH18S	Y	Y	Y	18" U-Handle	2 lbs
UH21	UH21S	Y	Y	N	21" U-Handle	3 lbs
UH24	UH24S	Y	Y	Y	24" U-Handle	3 lbs



UH18

### Tie Bars

Required with rigid casters to ensure rigid alignment. Tie bar length should match up to shelf depth. Rigid casters sold separately. **Finish:** Chrome

MODEL NO.	DESCRIPTION	SHIP WGT
18TB	One 18" Tie Bar which Fits 2 Casters	2 lbs
21TB	One 21" Tie Bar which Fits 2 Casters	2 lbs
24TB	One 24" Tie Bar which Fits 2 Casters	2 lbs
30TB	One 30" Tie Bar which Fits 2 Casters	2 lbs
36TB	One 36" Tie Bar which Fits 2 Casters	3 lbs



18TB



WCSD-1820

### Post Clamps

Joins multiple units of shelving. **Finish:** Chrome

MODEL NO.	DESCRIPTION	SHIP WGT
PCL1	1/2" Post Clamp	1 lb
PCL2	3-1/3" Post Clamp	1 lb



PCL2

**Conductive Accessories**



**ESD-DC**  
Drag Chain

Drag chain is mounted to bottom of shelf and is used to ground standard wire shelving units. Recommended to be used in conjunction with aluminum or plastic conductive split sleeves and conductive casters.



**WR-SSCO**  
Plastic Conductive Split Sleeve  
Sold as a pack of 4 pairs.



**ESD-SS**  
Aluminum Split Sleeve  
Aluminum Split Sleeves required when grounding standard wire shelving in conductive applications. Sold as a pack of 4 pairs.



**S-HOOK**  
Chrome



**S-HOOKSS**  
Stainless Steel



**S-HOOKP**  
Proform Green Epoxy



**S-Hooks**

For continuous runs of shelving. Two hooks should be used per shelf where two posts are not utilized. Sold as an 8 pack. **Finishes:** Chrome, Stainless Steel, Proform Green, Gray and Black Epoxy



**S-HOOKGY**  
Gray Epoxy



**S-HOOKBK**  
Black Epoxy



**FP**  
Post Foot Plate  
Triangular plate allows additional surface to disperse weight.  
**Finish:** Chrome



**FG**  
Non-Marring Floor Glides  
Affixes to bottom of bolt. Serves as protection to prevent marring of floors.  
Sold as a pack of 4 pieces.



**WR-SP**  
Shelf Collar Plug  
Sold as a pack of 4 pieces.  
**Finish:** Chrome



**WR-WMB, WR-WMBP**  
Post Wall Mount Bracket  
Mounts post to wall securely. 2" clearance required.  
**Finish:** Chrome and Green Epoxy



**WR-SS**  
Split Sleeve  
Sold as a pack of 4 pairs.  
(Enough for one shelf)



**WR-PMGP**  
Post Mount Grid Bracket  
Sold as a pack of 4 pieces.

**Collar Hooks**



Used to secure baskets to posts or as a hook for longer items. Sold in packs of four.

MODEL NO.	DESCRIPTION	SHIP WGT
SCH1-5	1-1/2" Hook (4 Pack)	1 lb
SCH1	1/2" Hook (4 Pack)	1 lb

**Seismic Foot Plates**

Quantum's seismic foot plates are used to anchor stationary shelving units to the floor.

MODEL NO.	DESCRIPTION	SHIP WGT
WR-SFP	Single Seismic Foot Plate	3 lbs
WR-DFP	Double Seismic Foot Plate	4 lbs

**OSHPD Certification**

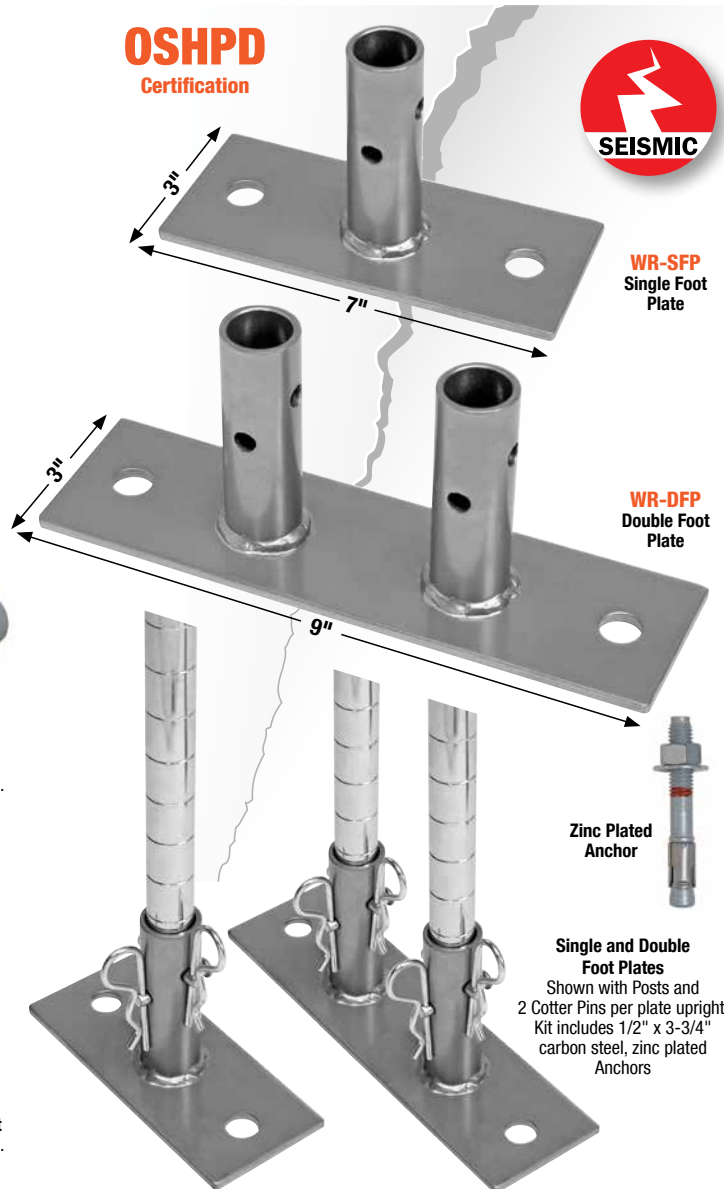

**WR-SFP**  
Single Foot Plate

**WR-DFP**  
Double Foot Plate

Zinc Plated Anchor

**Single and Double Foot Plates**  
Shown with Posts and 2 Cotter Pins per plate upright. Kit includes 1/2" x 3-3/4" carbon steel, zinc plated Anchors

**ADD YOUR CASTER KIT  
TO YOUR UNIT FOR  
MOBILITY**

**Up to 800-3,200 lb.  
MOBILE LOAD CAPACITY**



**Donut Bumper**

Non-marking, 3" diameter polyethylene bumper used to protect walls and help cushion impact.

MODEL NO.	DESCRIPTION	SHIP WGT
DB	One 3" Diameter Donut Bumper	1 lb

**Casters**

MODEL NO.	DESCRIPTION	LOAD CAPACITY PER CASTER	SHIP WGT
<b>Stem Casters</b>			
WR-00H	Four Swivel 5" x 1-1/4" Thermoplastic Resin Casters, 2 with brake	300 lbs	10 lbs
WR-00H-HD <b>NEW</b>	Four Swivel 5-1/2" x 1-1/4" Heavy-Duty Polyurethane Casters, 2 with brake	600 lbs	12 lbs
WR-00HS	Four Swivel 5" x 1-1/4" Polyurethane Stainless Steel Casters with Zerk Grease Fittings, 2 with brake	300 lbs	12 lbs
WR-00CO	Four Swivel ESD/Conductive 5" x 1-1/4" Casters, 2 with brake	300 lbs	12 lbs
WR-SB2R2*	Two Swivel 5" x 1-1/4" Thermoplastic Resin Caster with brake, 2 Rigid	300 lbs	12 lbs
WR-3	Four Swivel 3" Polyurethane Casters, all with brake	200 lbs	8 lbs
WR-RG*	One Rigid 5" x 1-1/4" Thermoplastic Resin Caster	300 lbs	3 lbs
WR-PS	One Swivel 8" x 2-1/2" Pneumatic Caster	325 lbs	4 lbs
PSC-5S	5"x1-1/4" Polymer Swivel Casters, 2 with brake	200 lbs	9 lbs
<b>Plate Casters</b>			
PT-PS	One Swivel 5" x 1-1/4" Thermoplastic Resin Caster	300 lbs	3 lbs
PT-PR	One Rigid 5" x 1-1/4" Thermoplastic Resin Caster	300 lbs	3 lbs
PT-PSB	One Swivel 5" x 1-1/4" Thermoplastic Resin Caster with brake	300 lbs	3 lbs
PT-PS-S	One Swivel 5" x 1-1/4" Polyurethane Stainless Steel Caster with Zerk Grease Fittings	300 lbs	3 lbs
PT-PR-S	One Rigid 5" x 1-1/4" Polyurethane Stainless Steel Caster with Zerk Grease Fittings	300 lbs	3 lbs
PT-PSB-S	One Swivel 5" x 1-1/4" Polyurethane Stainless Steel Caster with brake with Zerk Grease Fittings	300 lbs	3 lbs
PT-PS6	One Swivel 6" x 2" Polyurethane Caster	800 lbs	5 lbs
PT-PR6	One Rigid 6" x 2" Polyurethane Caster	800 lbs	5 lbs
PT-PSB6	One Swivel 6" x 2" Polyurethane Caster with brake	800 lbs	5 lbs
PT-NS	One Swivel 8" x 2-1/2" Pneumatic Caster	325 lbs	4 lbs
PT-NR	One Rigid 8" x 2-1/2" Pneumatic Caster	325 lbs	4 lbs

\*Requires Tie Bars for rigid alignment (See pg. 165)



**WR-00H**  
Thermoplastic Resin Stem Casters  
Shown with and without brake  
Sold as a set of 4 casters, 2 with brake



**WR-00H-HD**  
Heavy-Duty Polyurethane Stem Casters  
Shown with and without brake  
Sold as a set of 4 casters, 2 with brake



**WR-00CO**  
Conductive Stem Casters  
Shown with and without brake  
Sold as a set of 4 casters, 2 with brake



**WR-00HS**  
Stainless Steel Stem Casters  
Shown with and without brake  
Sold as a set of 4 casters, 2 with brake



**PSC-5S**  
Polymer Stem Casters  
Shown with and without brake  
Sold as a set of 4 casters, 2 with brake



**PT-PR**  
Rigid Thermoplastic Resin Plate Casters



**PT-PSB**  
Thermoplastic Resin Plate Casters  
Shown with and without brake



**PT-PS**  
Rigid Thermoplastic Resin Plate Casters  
Requires Tie Bar  
(See chart pg. 165)



**WR-RG**  
Rigid Thermoplastic Resin Stem Casters  
Requires Tie Bar  
(See chart pg. 165)

**WR-3**  
3" Polyurethane Stem Casters  
Sold as a set of 4 casters, all with brake



**PT-PR6**  
Rigid Polyurethane Plate Casters



**PT-PSB6**  
Polyurethane Plate Casters  
Shown with and without brake



**PT-PS6**



**WR-PS**  
Pneumatic Stem Casters



**PT-NR**  
Rigid Pneumatic Plate Casters



**PT-NS**  
Pneumatic Plate Casters

Millenia Shelving



Millenia™ Shelving guarantees a premium storage option. This innovative new shelving system combines an easy-to-clean product coupled with cost efficient technologies. System offers a multi-functional design and lifetime warranty against rust and corrosion. Unique dunnage add-on supports, add stability and increases weight capacity on the bottom shelf. Quantum expert shelving consultants can help you prepare a complimentary 2D or 3D layout to optimize your space.

**NEW**



**APPLICATIONS**

Food service, walk-in coolers, healthcare storage, supermarket. Suitable to be used in wet, humid, or dry environments and applications.



**EASY TO ASSEMBLE AND INSTALL**

Shelves come preassembled for easier installation and can be adjusted on a 1" increment. No tools required.



**EASY TO CLEAN**

Shelf plates can be easily removed for cleaning by hand or industrial dishwasher.

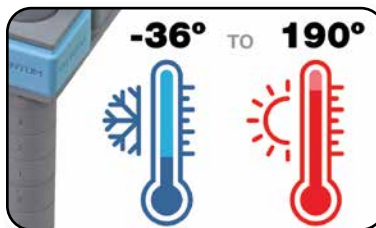

**TEMPERATURE RANGE**

With a wide temperature range, Millenia Shelving can be used in all extreme environments:

- Dry Storage
- Wet Storage
- Coolers
- Freezers



**RUST AND CORROSION FREE**

All Millenia Shelving is supported by a lifetime warranty against rust and corrosion. Its polymer composition makes it resistant to abrasive chemicals and wet environments.

**PERFORMANCE FEATURES:**

- Lifetime limited warranty
- Shelving unit materials:
  - Beams/Side Connectors/Adjustable Foot/Shelf Conus/Connector: Pultruded with glass fibers and thermoset resin composite
  - Shelf Plates: Polypropylene (available in vented or solid)
  - Bumper: Reinforced nylon
  - Post Cap: Polypropylene
- Up to 1,000 lb. load capacity per shelf evenly distributed and up to 2,000 lb. overall shelving unit *\*Dunnage stand recommended for units with 54" and longer shelves*
- No tools required for assembly
- National Sanitation Foundation (NSF) Approved
- Mobile capability available
- Shipped KD Class 92.5

**WIDTHS (W):** 18", 21", 24"

**LENGTHS (L):** 24", 30", 36", 42", 48", 54", 60", 72"

**HEIGHTS (H):** 14", 26", 38", 50", 62", 74", 86", 98"



**CAD DESIGN**

Design assistance is available for all your projects from room layouts to shelving or cart design. We'll create and develop an integrated system around your requirements. Layouts can be created to accommodate your space with the appropriate product mix.

Quantum offers the most complete package of storage products to satisfy all your requirements. Let us review your next project to maximize your storage space.

- Industry Exclusive 3D Modeling
- Blueprint & AutoCAD Compatible
- Space Utilization & Maximization
- Plan-o-grams



**NEW**



Millenia Shelving

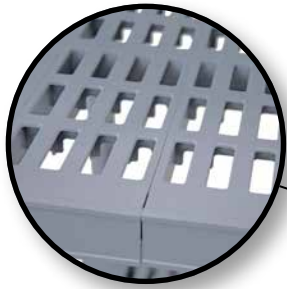

**SHELF WITH VENTED SURFACE**



**PRIVATE LABEL CAPABILITY**



**SHELF WITH SOLID SURFACE**



**SOLID BOTTOM SHELF AIDS IN PROTECTING PRODUCT FROM DUST AND DIRT COMING FROM THE GROUND**



**UNIT CAN BE STATIONARY OR MOBILE**

**Maximum load capacity evenly distributed**

\*Extra reinforcement dunnage stand recommended for units with 54" and longer shelves

**Up to 1,000 lb.**  
**LOAD CAPACITY PER SHELF**

## TRANSFORMING THE WAY YOU WORK AND STORE

### Optimized Space Utilization

By using various accessories, multiple shelving configurations become possible without compromising the maximum load capacity of the shelving system.

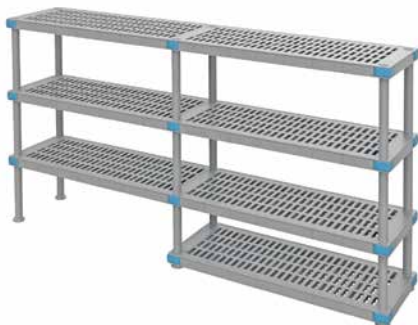

**ADD-ON UNIT CAPABILITY (SIDE TO SIDE)**



**ADD-ON UNIT CAPABILITY (L-SHAPE)**



**ADD-ON UNIT CAPABILITY (U-SHAPE)**

Millenia Shelves



Each shelf includes 4 packs of split sleeves **QPSS** and 4 support gussets **QPG**.

Up to **1,000 lb.** LOAD CAPACITY PER SHELF



**GUSSETS QPG**

Included with all shelves for extra support (Sold as 4-pack)

MODEL NO.	NOMINAL DIMENSIONS W" x L"	SHIP WGT
<b>Millenia Shelving Solid Shelves</b>		
QP1824SS	18" x 24"	6 lbs
QP1830SS	18" x 30"	7 lbs
QP1836SS	18" x 36"	9 lbs
QP1842SS	18" x 42"	10 lbs
QP1848SS	18" x 48"	11 lbs
QP1854SS	18" x 54"	12 lbs
QP1860SS	18" x 60"	13 lbs
QP1872SS	18" x 72"	15 lbs
QP2124SS	21" x 24"	7 lbs
QP2130SS	21" x 30"	8 lbs
QP2136SS	21" x 36"	9 lbs
QP2142SS	21" x 42"	10 lbs
QP2148SS	21" x 48"	12 lbs
QP2154SS	21" x 54"	13 lbs
QP2160SS	21" x 60"	14 lbs
QP2172SS	21" x 72"	16 lbs
QP2424SS	24" x 24"	8 lbs
QP2430SS	24" x 30"	10 lbs
QP2436SS	24" x 36"	12 lbs
QP2442SS	24" x 42"	13 lbs
QP2448SS	24" x 48"	15 lbs
QP2454SS	24" x 54"	16 lbs
QP2460SS	24" x 60"	18 lbs
QP2472SS	24" x 72"	21 lbs
<b>Millenia Shelving Vented Shelves</b>		
QP1824VS	18" x 24"	6 lbs
QP1830VS	18" x 30"	7 lbs
QP1836VS	18" x 36"	8 lbs
QP1842VS	18" x 42"	9 lbs
QP1848VS	18" x 48"	10 lbs
QP1854VS	18" x 54"	11 lbs
QP1860VS	18" x 60"	12 lbs
QP1872VS	18" x 72"	14 lbs
QP2124VS	21" x 24"	6 lbs
QP2130VS	21" x 30"	8 lbs
QP2136VS	21" x 36"	9 lbs
QP2142VS	21" x 42"	10 lbs
QP2148VS	21" x 48"	11 lbs
QP2154VS	21" x 54"	12 lbs
QP2160VS	21" x 60"	13 lbs
QP2172VS	21" x 72"	15 lbs
QP2424VS	24" x 24"	8 lbs
QP2430VS	24" x 30"	9 lbs
QP2436VS	24" x 36"	11 lbs
QP2442VS	24" x 42"	12 lbs
QP2448VS	24" x 48"	13 lbs
QP2454VS	24" x 54"	15 lbs
QP2460VS	24" x 60"	16 lbs
QP2472VS	24" x 72"	19 lbs



**SOLID SHELF QP1836SS**

(Plates can be removed and are dishwasher safe)



**NEW**



**VENTED SHELF QP1836VS**

(Plates can be removed and are dishwasher safe)



**SLEEVES QPSS**

Included with all shelves (Sold as 4-pack)



**POST CAP QPPC**

(Sold as 4-pack)



**POST QPP14**

**FLOOR ADAPTER QPFA**

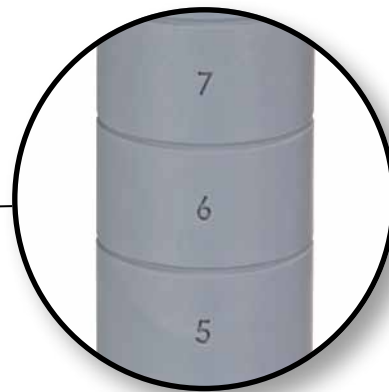

SHELF CAN BE ADJUSTED ON A 1" INCREMENTS. NO TOOLS REQUIRED

Millenia Posts



Each post includes post cap **QPPC** and floor adapter **QPFA**.

MODEL NO.	NOMINAL DIMENSIONS H"	SHIP WGT
<b>Millenia Shelving Posts</b>		
QPP14*	14"	1 lb
QPP26*	26"	1 lb
QPP38*	38"	2 lbs
QPP50*	50"	2 lbs
QPP62*	62"	2 lbs
QPP74*	74"	3 lbs
QPP86*	86"	3 lbs
QPP98	98"	3 lbs

To order posts for mobile use, replace **QPP** with **QPPM** in Model Number



LOWEST PRICE GUARANTEE

Millenia Vented Shelf Units



Vented shelves allow for storage from small to large items. Open grid surface allows for air circulation and minimal dust buildup. All vented complete shelf units consist of 4 or 5 shelves and 4 posts. Mobilize starter kit shelving unit using optional mobile kit.

**Up to 1,000 lb.**  
LOAD CAPACITY PER SHELF

**OPTIONAL MOBILE KIT**  
QPPSC-5S

Includes four 5"x1-1/4" Polymer swivel casters, 2 with brake and four donut bumpers  
Up to 800 lb. mobile load capacity (evenly distributed)



MODEL NO.	NOMINAL DIMENSIONS W" x L" x H"	SHIP WGT
<b>50" Millenia 4 Shelf Vented Shelving Unit</b>		
QP182450VS-4	18" x 24" x 50"	31 lbs
QP183050VS-4	18" x 30" x 50"	35 lbs
QP183650VS-4	18" x 36" x 50"	39 lbs
QP184250VS-4	18" x 42" x 50"	43 lbs
QP184850VS-4	18" x 48" x 50"	47 lbs
QP185450VS-4	18" x 54" x 50"	52 lbs
QP186050VS-4	18" x 60" x 50"	56 lbs
QP187250VS-4	18" x 72" x 50"	64 lbs
QP212450VS-4	21" x 24" x 50"	33 lbs
QP213050VS-4	21" x 30" x 50"	37 lbs
QP213650VS-4	21" x 36" x 50"	42 lbs
QP214250VS-4	21" x 42" x 50"	46 lbs
QP214850VS-4	21" x 48" x 50"	50 lbs
QP215450VS-4	21" x 54" x 50"	56 lbs
QP216050VS-4	21" x 60" x 50"	60 lbs
QP217250VS-4	21" x 72" x 50"	69 lbs
QP242450VS-4	24" x 24" x 50"	39 lbs
QP243050VS-4	24" x 30" x 50"	45 lbs
QP243650VS-4	24" x 36" x 50"	50 lbs
QP244250VS-4	24" x 42" x 50"	56 lbs
QP244850VS-4	24" x 48" x 50"	61 lbs
QP245450VS-4	24" x 54" x 50"	68 lbs
QP246050VS-4	24" x 60" x 50"	74 lbs
QP247250VS-4	24" x 72" x 50"	84 lbs

MODEL NO.	NOMINAL DIMENSIONS W" x L" x H"	SHIP WGT
<b>50" Millenia 5 Shelf Vented Shelving Unit</b>		
QP182450VS-5	18" x 24" x 50"	37 lbs
QP183050VS-5	18" x 30" x 50"	42 lbs
QP183650VS-5	18" x 36" x 50"	47 lbs
QP184250VS-5	18" x 42" x 50"	52 lbs
QP184850VS-5	18" x 48" x 50"	57 lbs
QP185450VS-5	18" x 54" x 50"	63 lbs
QP186050VS-5	18" x 60" x 50"	68 lbs
QP187250VS-5	18" x 72" x 50"	78 lbs
QP212450VS-5	21" x 24" x 50"	40 lbs
QP213050VS-5	21" x 30" x 50"	45 lbs
QP213650VS-5	21" x 36" x 50"	50 lbs
QP214250VS-5	21" x 42" x 50"	56 lbs
QP214850VS-5	21" x 48" x 50"	61 lbs
QP215450VS-5	21" x 54" x 50"	68 lbs
QP216050VS-5	21" x 60" x 50"	73 lbs
QP217250VS-5	21" x 72" x 50"	84 lbs
QP242450VS-5	24" x 24" x 50"	48 lbs
QP243050VS-5	24" x 30" x 50"	54 lbs
QP243650VS-5	24" x 36" x 50"	61 lbs
QP244250VS-5	24" x 42" x 50"	68 lbs
QP244850VS-5	24" x 48" x 50"	75 lbs
QP245450VS-5	24" x 54" x 50"	83 lbs
QP246050VS-5	24" x 60" x 50"	90 lbs
QP247250VS-5	24" x 72" x 50"	103 lbs

MODEL NO.	NOMINAL DIMENSIONS W" x L" x H"	SHIP WGT
<b>62" Millenia 4 Shelf Vented Shelving Unit</b>		
QP182462VS-4	18" x 24" x 62"	33 lbs
QP183062VS-4	18" x 30" x 62"	37 lbs
QP183662VS-4	18" x 36" x 62"	41 lbs
QP184262VS-4	18" x 42" x 62"	45 lbs
QP184862VS-4	18" x 48" x 62"	49 lbs
QP185462VS-4	18" x 54" x 62"	54 lbs
QP186062VS-4	18" x 60" x 62"	58 lbs
QP187262VS-4	18" x 72" x 62"	66 lbs
QP212462VS-4	21" x 24" x 62"	35 lbs
QP213062VS-4	21" x 30" x 62"	39 lbs
QP213662VS-4	21" x 36" x 62"	43 lbs
QP214262VS-4	21" x 42" x 62"	48 lbs
QP214862VS-4	21" x 48" x 62"	52 lbs
QP215462VS-4	21" x 54" x 62"	58 lbs
QP216062VS-4	21" x 60" x 62"	62 lbs
QP217262VS-4	21" x 72" x 62"	71 lbs
QP242462VS-4	24" x 24" x 62"	41 lbs
QP243062VS-4	24" x 30" x 62"	47 lbs
QP243662VS-4	24" x 36" x 62"	52 lbs
QP244262VS-4	24" x 42" x 62"	57 lbs
QP244862VS-4	24" x 48" x 62"	63 lbs
QP245462VS-4	24" x 54" x 62"	70 lbs
QP246062VS-4	24" x 60" x 62"	75 lbs
QP247262VS-4	24" x 72" x 62"	86 lbs

MODEL NO.	NOMINAL DIMENSIONS W" x L" x H"	SHIP WGT
<b>62" Millenia 5 Shelf Vented Shelving Unit</b>		
QP182462VS-5	18" x 24" x 62"	39 lbs
QP183062VS-5	18" x 30" x 62"	44 lbs
QP183662VS-5	18" x 36" x 62"	49 lbs
QP184262VS-5	18" x 42" x 62"	54 lbs
QP184862VS-5	18" x 48" x 62"	59 lbs
QP185462VS-5	18" x 54" x 62"	65 lbs
QP186062VS-5	18" x 60" x 62"	70 lbs
QP187262VS-5	18" x 72" x 62"	80 lbs
QP212462VS-5	21" x 24" x 62"	41 lbs
QP213062VS-5	21" x 30" x 62"	47 lbs
QP213662VS-5	21" x 36" x 62"	52 lbs
QP214262VS-5	21" x 42" x 62"	57 lbs
QP214862VS-5	21" x 48" x 62"	63 lbs
QP215462VS-5	21" x 54" x 62"	70 lbs
QP216062VS-5	21" x 60" x 62"	75 lbs
QP217262VS-5	21" x 72" x 62"	86 lbs
QP242462VS-5	24" x 24" x 62"	49 lbs
QP243062VS-5	24" x 30" x 62"	56 lbs
QP243662VS-5	24" x 36" x 62"	63 lbs
QP244262VS-5	24" x 42" x 62"	70 lbs
QP244862VS-5	24" x 48" x 62"	76 lbs
QP245462VS-5	24" x 54" x 62"	85 lbs
QP246062VS-5	24" x 60" x 62"	91 lbs
QP247262VS-5	24" x 72" x 62"	105 lbs

MODEL NO.	NOMINAL DIMENSIONS W" x L" x H"	SHIP WGT
<b>74" Millenia 4 Shelf Vented Shelving Unit</b>		
QP182474VS-4	18" x 24" x 74"	35 lbs
QP183074VS-4	18" x 30" x 74"	39 lbs
QP183674VS-4	18" x 36" x 74"	43 lbs
QP184274VS-4	18" x 42" x 74"	46 lbs
QP184874VS-4	18" x 48" x 74"	50 lbs
QP185474VS-4	18" x 54" x 74"	56 lbs
QP186074VS-4	18" x 60" x 74"	60 lbs
QP187274VS-4	18" x 72" x 74"	67 lbs
QP212474VS-4	21" x 24" x 74"	36 lbs
QP213074VS-4	21" x 30" x 74"	41 lbs
QP213674VS-4	21" x 36" x 74"	45 lbs
QP214274VS-4	21" x 42" x 74"	49 lbs
QP214874VS-4	21" x 48" x 74"	54 lbs
QP215474VS-4	21" x 54" x 74"	59 lbs
QP216074VS-4	21" x 60" x 74"	64 lbs
QP217274VS-4	21" x 72" x 74"	72 lbs
QP242474VS-4	24" x 24" x 74"	43 lbs
QP243074VS-4	24" x 30" x 74"	48 lbs
QP243674VS-4	24" x 36" x 74"	54 lbs
QP244274VS-4	24" x 42" x 74"	59 lbs
QP244874VS-4	24" x 48" x 74"	65 lbs
QP245474VS-4	24" x 54" x 74"	72 lbs
QP246074VS-4	24" x 60" x 74"	77 lbs
QP247274VS-4	24" x 72" x 74"	88 lbs

MODEL NO.	NOMINAL DIMENSIONS W" x L" x H"	SHIP WGT
<b>74" Millenia 5 Shelf Vented Shelving Unit</b>		
QP182474VS-5	18" x 24" x 74"	41 lbs
QP183074VS-5	18" x 30" x 74"	46 lbs
QP183674VS-5	18" x 36" x 74"	51 lbs
QP184274VS-5	18" x 42" x 74"	55 lbs
QP184874VS-5	18" x 48" x 74"	60 lbs
QP185474VS-5	18" x 54" x 74"	67 lbs
QP186074VS-5	18" x 60" x 74"	72 lbs
QP187274VS-5	18" x 72" x 74"	81 lbs
QP212474VS-5	21" x 24" x 74"	43 lbs
QP213074VS-5	21" x 30" x 74"	48 lbs
QP213674VS-5	21" x 36" x 74"	54 lbs
QP214274VS-5	21" x 42" x 74"	59 lbs
QP214874VS-5	21" x 48" x 74"	64 lbs
QP215474VS-5	21" x 54" x 74"	71 lbs
QP216074VS-5	21" x 60" x 74"	77 lbs
QP217274VS-5	21" x 72" x 74"	87 lbs
QP242474VS-5	24" x 24" x 74"	51 lbs
QP243074VS-5	24" x 30" x 74"	58 lbs
QP243674VS-5	24" x 36" x 74"	64 lbs
QP244274VS-5	24" x 42" x 74"	71 lbs
QP244874VS-5	24" x 48" x 74"	78 lbs
QP245474VS-5	24" x 54" x 74"	86 lbs
QP246074VS-5	24" x 60" x 74"	93 lbs
QP247274VS-5	24" x 72" x 74"	107 lbs

MODEL NO.	NOMINAL DIMENSIONS W" x L" x H"	SHIP WGT
<b>86" Millenia 4 Shelf Vented Shelving Unit</b>		
QP182486VS-4	18" x 24" x 86"	36 lbs
QP183086VS-4	18" x 30" x 86"	40 lbs
QP183686VS-4	18" x 36" x 86"	44 lbs
QP184286VS-4	18" x 42" x 86"	48 lbs
QP184886VS-4	18" x 48" x 86"	52 lbs
QP185486VS-4	18" x 54" x 86"	57 lbs
QP186086VS-4	18" x 60" x 86"	61 lbs
QP187286VS-4	18" x 72" x 86"	69 lbs
QP212486VS-4	21" x 24" x 86"	38 lbs
QP213086VS-4	21" x 30" x 86"	42 lbs
QP213686VS-4	21" x 36" x 86"	47 lbs
QP214286VS-4	21" x 42" x 86"	51 lbs
QP214886VS-4	21" x 48" x 86"	55 lbs
QP215486VS-4	21" x 54" x 86"	61 lbs
QP216086VS-4	21" x 60" x 86"	65 lbs
QP217286VS-4	21" x 72" x 86"	74 lbs
QP242486VS-4	24" x 24" x 86"	44 lbs
QP243086VS-4	24" x 30" x 86"	50 lbs
QP243686VS-4	24" x 36" x 86"	55 lbs
QP244286VS-4	24" x 42" x 86"	61 lbs
QP244886VS-4	24" x 48" x 86"	66 lbs
QP245486VS-4	24" x 54" x 86"	73 lbs
QP246086VS-4	24" x 60" x 86"	79 lbs
QP247286VS-4	24" x 72" x 86"	89 lbs

MODEL NO.	NOMINAL DIMENSIONS W" x L" x H"	SHIP WGT
<b>86" Millenia 5 Shelf Vented Shelving Unit</b>		
QP182486VS-5	18" x 24" x 86"	42 lbs
QP183086VS-5	18" x 30" x 86"	47 lbs
QP183686VS-5	18" x 36" x 86"	52 lbs
QP184286VS-5	18" x 42" x 86"	57 lbs
QP184886VS-5	18" x 48" x 86"	62 lbs
QP185486VS-5	18" x 54" x 86"	68 lbs
QP186086VS-5	18" x 60" x 86"	73 lbs
QP187286VS-5	18" x 72" x 86"	83 lbs
QP212486VS-5	21" x 24" x 86"	45 lbs
QP213086VS-5	21" x 30" x 86"	50 lbs
QP213686VS-5	21" x 36" x 86"	55 lbs
QP214286VS-5	21" x 42" x 86"	61 lbs
QP214886VS-5	21" x 48" x 86"	66 lbs
QP215486VS-5	21" x 54" x 86"	73 lbs
QP216086VS-5	21" x 60" x 86"	78 lbs
QP217286VS-5	21" x 72" x 86"	89 lbs
QP242486VS-5	24" x 24" x 86"	53 lbs
QP243086VS-5	24" x 30" x 86"	59 lbs
QP243686VS-5	24" x 36" x 86"	66 lbs
QP244286VS-5	24" x 42" x 86"	73 lbs
QP244886VS-5	24" x 48" x 86"	80 lbs
QP245486VS-5	24" x 54" x 86"	88 lbs
QP246086VS-5	24" x 60" x 86"	95 lbs
QP247286VS-5	24" x 72" x 86"	108 lbs

\*PACKAGED AS SINGLE BOX SHELVING UNITS Each box includes 4 posts, 4 open grid shelves with removable shelf plates, 1 package of needed split sleeves, post caps, post levelers, gussets and wall brackets

Millenia Solid Shelf Units



Solid bottom shelf aids in protecting product from dust and dirt coming from the ground. All solid complete shelf units consist of 4 or 5 shelves and 4 posts. Mobilize starter kit shelving unit using optional mobile kit.

**NEW**

**Up to 1,000 lb.**  
LOAD CAPACITY PER SHELF

**OPTIONAL MOBILE KIT**  
QPPSC-5S

Includes four 5"x1-1/4" Polymer swivel casters, 2 with brake and four donut bumpers  
Up to 800 lb. mobile load capacity (evenly distributed)



4 SHELF SOLID UNIT



5 SHELF SOLID UNIT

MODEL NO.	NOMINAL DIMENSIONS W" x L" x H"	SHIP WGT
<b>50" Millenia 4 Shelf Solid Shelving Unit</b>		
QP182450SS-4	18" x 24" x 50"	33 lbs
QP183050SS-4	18" x 30" x 50"	37 lbs
QP183650SS-4	18" x 36" x 50"	41 lbs
QP184250SS-4	18" x 42" x 50"	46 lbs
QP184850SS-4	18" x 48" x 50"	50 lbs
QP185450SS-4	18" x 54" x 50"	56 lbs
QP186050SS-4	18" x 60" x 50"	60 lbs
QP187250SS-4	18" x 72" x 50"	69 lbs
QP212450SS-4	21" x 24" x 50"	35 lbs
QP213050SS-4	21" x 30" x 50"	39 lbs
QP213650SS-4	21" x 36" x 50"	44 lbs
QP214250SS-4	21" x 42" x 50"	49 lbs
QP214850SS-4	21" x 48" x 50"	54 lbs
QP215450SS-4	21" x 54" x 50"	60 lbs
QP216050SS-4	21" x 60" x 50"	65 lbs
QP217250SS-4	21" x 72" x 50"	75 lbs
QP242450SS-4	24" x 24" x 50"	41 lbs
QP243050SS-4	24" x 30" x 50"	47 lbs
QP243650SS-4	24" x 36" x 50"	53 lbs
QP244250SS-4	24" x 42" x 50"	59 lbs
QP244850SS-4	24" x 48" x 50"	65 lbs
QP245450SS-4	24" x 54" x 50"	73 lbs
QP246050SS-4	24" x 60" x 50"	79 lbs
QP247250SS-4	24" x 72" x 50"	91 lbs
<b>50" Millenia 5 Shelf Solid Shelving Unit</b>		
QP182450SS-5	18" x 24" x 50"	39 lbs
QP183050SS-5	18" x 30" x 50"	45 lbs
QP183650SS-5	18" x 36" x 50"	50 lbs
QP184250SS-5	18" x 42" x 50"	55 lbs
QP184850SS-5	18" x 48" x 50"	61 lbs
QP185450SS-5	18" x 54" x 50"	68 lbs
QP186050SS-5	18" x 60" x 50"	73 lbs
QP187250SS-5	18" x 72" x 50"	84 lbs
QP212450SS-5	21" x 24" x 50"	42 lbs
QP213050SS-5	21" x 30" x 50"	48 lbs
QP213650SS-5	21" x 36" x 50"	54 lbs
QP214250SS-5	21" x 42" x 50"	60 lbs
QP214850SS-5	21" x 48" x 50"	66 lbs
QP215450SS-5	21" x 54" x 50"	73 lbs
QP216050SS-5	21" x 60" x 50"	79 lbs
QP217250SS-5	21" x 72" x 50"	91 lbs
QP242450SS-5	24" x 24" x 50"	50 lbs
QP243050SS-5	24" x 30" x 50"	57 lbs
QP243650SS-5	24" x 36" x 50"	65 lbs
QP244250SS-5	24" x 42" x 50"	72 lbs
QP244850SS-5	24" x 48" x 50"	80 lbs
QP245450SS-5	24" x 54" x 50"	89 lbs
QP246050SS-5	24" x 60" x 50"	96 lbs
QP247250SS-5	24" x 72" x 50"	112 lbs

MODEL NO.	NOMINAL DIMENSIONS W" x L" x H"	SHIP WGT
<b>62" Millenia 4 Shelf Solid Shelving Unit</b>		
QP182462SS-4	18" x 24" x 62"	34 lbs
QP183062SS-4	18" x 30" x 62"	39 lbs
QP183662SS-4	18" x 36" x 62"	43 lbs
QP184262SS-4	18" x 42" x 62"	47 lbs
QP184862SS-4	18" x 48" x 62"	52 lbs
QP185462SS-4	18" x 54" x 62"	58 lbs
QP186062SS-4	18" x 60" x 62"	62 lbs
QP187262SS-4	18" x 72" x 62"	71 lbs
QP212462SS-4	21" x 24" x 62"	36 lbs
QP213062SS-4	21" x 30" x 62"	41 lbs
QP213662SS-4	21" x 36" x 62"	46 lbs
QP214262SS-4	21" x 42" x 62"	51 lbs
QP214862SS-4	21" x 48" x 62"	56 lbs
QP215462SS-4	21" x 54" x 62"	62 lbs
QP216062SS-4	21" x 60" x 62"	67 lbs
QP217262SS-4	21" x 72" x 62"	76 lbs
QP242462SS-4	24" x 24" x 62"	43 lbs
QP243062SS-4	24" x 30" x 62"	49 lbs
QP243662SS-4	24" x 36" x 62"	55 lbs
QP244262SS-4	24" x 42" x 62"	61 lbs
QP244862SS-4	24" x 48" x 62"	67 lbs
QP245462SS-4	24" x 54" x 62"	75 lbs
QP246062SS-4	24" x 60" x 62"	81 lbs
QP247262SS-4	24" x 72" x 62"	93 lbs
<b>62" Millenia 5 Shelf Solid Shelving Unit</b>		
QP182462SS-5	18" x 24" x 62"	41 lbs
QP183062SS-5	18" x 30" x 62"	46 lbs
QP183662SS-5	18" x 36" x 62"	52 lbs
QP184262SS-5	18" x 42" x 62"	57 lbs
QP184862SS-5	18" x 48" x 62"	62 lbs
QP185462SS-5	18" x 54" x 62"	69 lbs
QP186062SS-5	18" x 60" x 62"	75 lbs
QP187262SS-5	18" x 72" x 62"	86 lbs
QP212462SS-5	21" x 24" x 62"	43 lbs
QP213062SS-5	21" x 30" x 62"	49 lbs
QP213662SS-5	21" x 36" x 62"	55 lbs
QP214262SS-5	21" x 42" x 62"	61 lbs
QP214862SS-5	21" x 48" x 62"	67 lbs
QP215462SS-5	21" x 54" x 62"	75 lbs
QP216062SS-5	21" x 60" x 62"	81 lbs
QP217262SS-5	21" x 72" x 62"	93 lbs
QP242462SS-5	24" x 24" x 62"	51 lbs
QP243062SS-5	24" x 30" x 62"	59 lbs
QP243662SS-5	24" x 36" x 62"	66 lbs
QP244262SS-5	24" x 42" x 62"	74 lbs
QP244862SS-5	24" x 48" x 62"	82 lbs
QP245462SS-5	24" x 54" x 62"	91 lbs
QP246062SS-5	24" x 60" x 62"	98 lbs
QP247262SS-5	24" x 72" x 62"	113 lbs

MODEL NO.	NOMINAL DIMENSIONS W" x L" x H"	SHIP WGT
<b>74" Millenia 4 Shelf Solid Shelving Unit</b>		
QP182474SS-4	18" x 24" x 74"	36 lbs
QP183074SS-4	18" x 30" x 74"	40 lbs
QP183674SS-4	18" x 36" x 74"	45 lbs
QP184274SS-4	18" x 42" x 74"	49 lbs
QP184874SS-4	18" x 48" x 74"	53 lbs
QP185474SS-4	18" x 54" x 74"	59 lbs
QP186074SS-4	18" x 60" x 74"	64 lbs
QP187274SS-4	18" x 72" x 74"	72 lbs
QP212474SS-4	21" x 24" x 74"	38 lbs
QP213074SS-4	21" x 30" x 74"	43 lbs
QP213674SS-4	21" x 36" x 74"	48 lbs
QP214274SS-4	21" x 42" x 74"	52 lbs
QP214874SS-4	21" x 48" x 74"	57 lbs
QP215474SS-4	21" x 54" x 74"	64 lbs
QP216074SS-4	21" x 60" x 74"	68 lbs
QP217274SS-4	21" x 72" x 74"	78 lbs
QP242474SS-4	24" x 24" x 74"	45 lbs
QP243074SS-4	24" x 30" x 74"	51 lbs
QP243674SS-4	24" x 36" x 74"	57 lbs
QP244274SS-4	24" x 42" x 74"	63 lbs
QP244874SS-4	24" x 48" x 74"	69 lbs
QP245474SS-4	24" x 54" x 74"	76 lbs
QP246074SS-4	24" x 60" x 74"	82 lbs
QP247274SS-4	24" x 72" x 74"	94 lbs
<b>74" Millenia 5 Shelf Solid Shelving Unit</b>		
QP182474SS-5	18" x 24" x 74"	42 lbs
QP183074SS-5	18" x 30" x 74"	48 lbs
QP183674SS-5	18" x 36" x 74"	53 lbs
QP184274SS-5	18" x 42" x 74"	59 lbs
QP184874SS-5	18" x 48" x 74"	64 lbs
QP185474SS-5	18" x 54" x 74"	71 lbs
QP186074SS-5	18" x 60" x 74"	76 lbs
QP187274SS-5	18" x 72" x 74"	87 lbs
QP212474SS-5	21" x 24" x 74"	45 lbs
QP213074SS-5	21" x 30" x 74"	51 lbs
QP213674SS-5	21" x 36" x 74"	57 lbs
QP214274SS-5	21" x 42" x 74"	63 lbs
QP214874SS-5	21" x 48" x 74"	69 lbs
QP215474SS-5	21" x 54" x 74"	76 lbs
QP216074SS-5	21" x 60" x 74"	82 lbs
QP217274SS-5	21" x 72" x 74"	94 lbs
QP242474SS-5	24" x 24" x 74"	53 lbs
QP243074SS-5	24" x 30" x 74"	61 lbs
QP243674SS-5	24" x 36" x 74"	68 lbs
QP244274SS-5	24" x 42" x 74"	76 lbs
QP244874SS-5	24" x 48" x 74"	83 lbs
QP245474SS-5	24" x 54" x 74"	92 lbs
QP246074SS-5	24" x 60" x 74"	100 lbs
QP247274SS-5	24" x 72" x 74"	115 lbs

MODEL NO.	NOMINAL DIMENSIONS W" x L" x H"	SHIP WGT
<b>86" Millenia 4 Shelf Solid Shelving Unit</b>		
QP182486SS-4	18" x 24" x 86"	38 lbs
QP183086SS-4	18" x 30" x 86"	42 lbs
QP183686SS-4	18" x 36" x 86"	46 lbs
QP184286SS-4	18" x 42" x 86"	51 lbs
QP184886SS-4	18" x 48" x 86"	55 lbs
QP185486SS-4	18" x 54" x 86"	61 lbs
QP186086SS-4	18" x 60" x 86"	65 lbs
QP187286SS-4	18" x 72" x 86"	74 lbs
QP212486SS-4	21" x 24" x 86"	40 lbs
QP213086SS-4	21" x 30" x 86"	44 lbs
QP213686SS-4	21" x 36" x 86"	49 lbs
QP214286SS-4	21" x 42" x 86"	54 lbs
QP214886SS-4	21" x 48" x 86"	59 lbs
QP215486SS-4	21" x 54" x 86"	65 lbs
QP216086SS-4	21" x 60" x 86"	70 lbs
QP217286SS-4	21" x 72" x 86"	80 lbs
QP242486SS-4	24" x 24" x 86"	46 lbs
QP243086SS-4	24" x 30" x 86"	52 lbs
QP243686SS-4	24" x 36" x 86"	58 lbs
QP244286SS-4	24" x 42" x 86"	64 lbs
QP244886SS-4	24" x 48" x 86"	70 lbs
QP245486SS-4	24" x 54" x 86"	78 lbs
QP246086SS-4	24" x 60" x 86"	84 lbs
QP247286SS-4	24" x 72" x 86"	96 lbs
<b>86" Millenia 5 Shelf Solid Shelving Unit</b>		
QP182486SS-5	18" x 24" x 86"	44 lbs
QP183086SS-5	18" x 30" x 86"	49 lbs
QP183686SS-5	18" x 36" x 86"	55 lbs
QP184286SS-5	18" x 42" x 86"	60 lbs
QP184886SS-5	18" x 48" x 86"	66 lbs
QP185486SS-5	18" x 54" x 86"	73 lbs
QP186086SS-5	18" x 60" x 86"	78 lbs
QP187286SS-5	18" x 72" x 86"	89 lbs
QP212486SS-5	21" x 24" x 86"	47 lbs
QP213086SS-5	21" x 30" x 86"	53 lbs
QP213686SS-5	21" x 36" x 86"	58 lbs
QP214286SS-5	21" x 42" x 86"	64 lbs
QP214886SS-5	21" x 48" x 86"	70 lbs
QP215486SS-5	21" x 54" x 86"	78 lbs
QP216086SS-5	21" x 60" x 86"	84 lbs
QP217286SS-5	21" x 72" x 86"	96 lbs
QP242486SS-5	24" x 24" x 86"	55 lbs
QP243086SS-5	24" x 30" x 86"	62 lbs
QP243686SS-5	24" x 36" x 86"	70 lbs
QP244286SS-5	24" x 42" x 86"	77 lbs
QP244886SS-5	24" x 48" x 86"	85 lbs
QP245486SS-5	24" x 54" x 86"	94 lbs
QP246086SS-5	24" x 60" x 86"	101 lbs
QP247286SS-5	24" x 72" x 86"	116 lbs

**Millenia Mixed Shelf Units**



Mixed units have all vented shelves and solid bottom shelf. All complete mix shelf units consist of 3 or 4 vented shelves with a solid bottom shelf and 4 posts. Mobilize starter kit shelving unit using optional mobile kit.

**Up to 1,000 lb.**  
**LOAD CAPACITY PER SHELF**

**OPTIONAL MOBILE KIT**  
**QPPSC-5S**

Includes four 5"x1-1/4" Polymer swivel casters, 2 with brake and four donut bumpers  
Up to 800 lb. mobile load capacity (evenly distributed)



**NEW**



**4 SHELF MIXED UNIT**



**5 SHELF MIXED UNIT**

MODEL NO.	NOMINAL DIMENSIONS W" x L" x H"	SHIP WGT
<b>62" Millenia 3 Vented 1 Solid Shelving Unit</b>		
QP182462V3S1	18" x 24" x 62"	33 lbs
QP183062V3S1	18" x 30" x 62"	37 lbs
QP183662V3S1	18" x 36" x 62"	41 lbs
QP184262V3S1	18" x 42" x 62"	45 lbs
QP184862V3S1	18" x 48" x 62"	49 lbs
QP185462V3S1	18" x 54" x 62"	55 lbs
QP186062V3S1	18" x 60" x 62"	59 lbs
QP187262V3S1	18" x 72" x 62"	67 lbs
QP212462V3S1	21" x 24" x 62"	35 lbs
QP213062V3S1	21" x 30" x 62"	40 lbs
QP213662V3S1	21" x 36" x 62"	44 lbs
QP214262V3S1	21" x 42" x 62"	48 lbs
QP214862V3S1	21" x 48" x 62"	53 lbs
QP215462V3S1	21" x 54" x 62"	59 lbs
QP216062V3S1	21" x 60" x 62"	63 lbs
QP217262V3S1	21" x 72" x 62"	72 lbs
QP242462V3S1	24" x 24" x 62"	42 lbs
QP243062V3S1	24" x 30" x 62"	47 lbs
QP243662V3S1	24" x 36" x 62"	53 lbs
QP244262V3S1	24" x 42" x 62"	58 lbs
QP244862V3S1	24" x 48" x 62"	64 lbs
QP245462V3S1	24" x 54" x 62"	71 lbs
QP246062V3S1	24" x 60" x 62"	77 lbs
QP247262V3S1	24" x 72" x 62"	88 lbs
<b>62" Millenia 4 Vented 1 Solid Shelving Unit</b>		
QP182462V4S1	18" x 24" x 62"	39 lbs
QP183062V4S1	18" x 30" x 62"	44 lbs
QP183662V4S1	18" x 36" x 62"	49 lbs
QP184262V4S1	18" x 42" x 62"	54 lbs
QP184862V4S1	18" x 48" x 62"	59 lbs
QP185462V4S1	18" x 54" x 62"	66 lbs
QP186062V4S1	18" x 60" x 62"	71 lbs
QP187262V4S1	18" x 72" x 62"	81 lbs
QP212462V4S1	21" x 24" x 62"	42 lbs
QP213062V4S1	21" x 30" x 62"	47 lbs
QP213662V4S1	21" x 36" x 62"	53 lbs
QP214262V4S1	21" x 42" x 62"	58 lbs
QP214862V4S1	21" x 48" x 62"	64 lbs
QP215462V4S1	21" x 54" x 62"	71 lbs
QP216062V4S1	21" x 60" x 62"	76 lbs
QP217262V4S1	21" x 72" x 62"	87 lbs
QP242462V4S1	24" x 24" x 62"	50 lbs
QP243062V4S1	24" x 30" x 62"	57 lbs
QP243662V4S1	24" x 36" x 62"	64 lbs
QP244262V4S1	24" x 42" x 62"	70 lbs
QP244862V4S1	24" x 48" x 62"	77 lbs
QP245462V4S1	24" x 54" x 62"	86 lbs
QP246062V4S1	24" x 60" x 62"	93 lbs
QP247262V4S1	24" x 72" x 62"	107 lbs

MODEL NO.	NOMINAL DIMENSIONS W" x L" x H"	SHIP WGT
<b>74" Millenia 3 Vented 1 Solid Shelving Unit</b>		
QP182474V3S1	18" x 24" x 74"	35 lbs
QP183074V3S1	18" x 30" x 74"	39 lbs
QP183674V3S1	18" x 36" x 74"	43 lbs
QP184274V3S1	18" x 42" x 74"	47 lbs
QP184874V3S1	18" x 48" x 74"	51 lbs
QP185474V3S1	18" x 54" x 74"	57 lbs
QP186074V3S1	18" x 60" x 74"	61 lbs
QP187274V3S1	18" x 72" x 74"	69 lbs
QP212474V3S1	21" x 24" x 74"	37 lbs
QP213074V3S1	21" x 30" x 74"	41 lbs
QP213674V3S1	21" x 36" x 74"	46 lbs
QP214274V3S1	21" x 42" x 74"	50 lbs
QP214874V3S1	21" x 48" x 74"	54 lbs
QP215474V3S1	21" x 54" x 74"	60 lbs
QP216074V3S1	21" x 60" x 74"	65 lbs
QP217274V3S1	21" x 72" x 74"	74 lbs
QP242474V3S1	24" x 24" x 74"	43 lbs
QP243074V3S1	24" x 30" x 74"	49 lbs
QP243674V3S1	24" x 36" x 74"	54 lbs
QP244274V3S1	24" x 42" x 74"	60 lbs
QP244874V3S1	24" x 48" x 74"	66 lbs
QP245474V3S1	24" x 54" x 74"	73 lbs
QP246074V3S1	24" x 60" x 74"	78 lbs
QP247274V3S1	24" x 72" x 74"	89 lbs
<b>74" Millenia 4 Vented 1 Solid Shelving Unit</b>		
QP182474V4S1	18" x 24" x 74"	41 lbs
QP183074V4S1	18" x 30" x 74"	46 lbs
QP183674V4S1	18" x 36" x 74"	51 lbs
QP184274V4S1	18" x 42" x 74"	56 lbs
QP184874V4S1	18" x 48" x 74"	61 lbs
QP185474V4S1	18" x 54" x 74"	68 lbs
QP186074V4S1	18" x 60" x 74"	73 lbs
QP187274V4S1	18" x 72" x 74"	83 lbs
QP212474V4S1	21" x 24" x 74"	43 lbs
QP213074V4S1	21" x 30" x 74"	49 lbs
QP213674V4S1	21" x 36" x 74"	54 lbs
QP214274V4S1	21" x 42" x 74"	60 lbs
QP214874V4S1	21" x 48" x 74"	65 lbs
QP215474V4S1	21" x 54" x 74"	72 lbs
QP216074V4S1	21" x 60" x 74"	78 lbs
QP217274V4S1	21" x 72" x 74"	89 lbs
QP242474V4S1	24" x 24" x 74"	51 lbs
QP243074V4S1	24" x 30" x 74"	58 lbs
QP243674V4S1	24" x 36" x 74"	65 lbs
QP244274V4S1	24" x 42" x 74"	72 lbs
QP244874V4S1	24" x 48" x 74"	79 lbs
QP245474V4S1	24" x 54" x 74"	88 lbs
QP246074V4S1	24" x 60" x 74"	94 lbs
QP247274V4S1	24" x 72" x 74"	108 lbs

MODEL NO.	NOMINAL DIMENSIONS W" x L" x H"	SHIP WGT
<b>86" Millenia 3 Vented 1 Solid Shelving Unit</b>		
QP182486V3S1	18" x 24" x 86"	38 lbs
QP183086V3S1	18" x 30" x 86"	42 lbs
QP183686V3S1	18" x 36" x 86"	46 lbs
QP184286V3S1	18" x 42" x 86"	51 lbs
QP184886V3S1	18" x 48" x 86"	55 lbs
QP185486V3S1	18" x 54" x 86"	61 lbs
QP186086V3S1	18" x 60" x 86"	65 lbs
QP187286V3S1	18" x 72" x 86"	74 lbs
QP212486V3S1	21" x 24" x 86"	40 lbs
QP213086V3S1	21" x 30" x 86"	44 lbs
QP213686V3S1	21" x 36" x 86"	49 lbs
QP214286V3S1	21" x 42" x 86"	54 lbs
QP214886V3S1	21" x 48" x 86"	59 lbs
QP215486V3S1	21" x 54" x 86"	65 lbs
QP216086V3S1	21" x 60" x 86"	70 lbs
QP217286V3S1	21" x 72" x 86"	80 lbs
QP242486V3S1	24" x 24" x 86"	46 lbs
QP243086V3S1	24" x 30" x 86"	52 lbs
QP243686V3S1	24" x 36" x 86"	58 lbs
QP244286V3S1	24" x 42" x 86"	64 lbs
QP244886V3S1	24" x 48" x 86"	70 lbs
QP245486V3S1	24" x 54" x 86"	78 lbs
QP246086V3S1	24" x 60" x 86"	84 lbs
QP247286V3S1	24" x 72" x 86"	96 lbs
<b>86" Millenia 4 Vented 1 Solid Shelving Unit</b>		
QP182486V4S1	18" x 24" x 86"	43 lbs
QP183086V4S1	18" x 30" x 86"	48 lbs
QP183686V4S1	18" x 36" x 86"	53 lbs
QP184286V4S1	18" x 42" x 86"	58 lbs
QP184886V4S1	18" x 48" x 86"	63 lbs
QP185486V4S1	18" x 54" x 86"	69 lbs
QP186086V4S1	18" x 60" x 86"	74 lbs
QP187286V4S1	18" x 72" x 86"	84 lbs
QP212486V4S1	21" x 24" x 86"	45 lbs
QP213086V4S1	21" x 30" x 86"	50 lbs
QP213686V4S1	21" x 36" x 86"	56 lbs
QP214286V4S1	21" x 42" x 86"	61 lbs
QP214886V4S1	21" x 48" x 86"	67 lbs
QP215486V4S1	21" x 54" x 86"	74 lbs
QP216086V4S1	21" x 60" x 86"	79 lbs
QP217286V4S1	21" x 72" x 86"	90 lbs
QP242486V4S1	24" x 24" x 86"	53 lbs
QP243086V4S1	24" x 30" x 86"	60 lbs
QP243686V4S1	24" x 36" x 86"	67 lbs
QP244286V4S1	24" x 42" x 86"	74 lbs
QP244886V4S1	24" x 48" x 86"	81 lbs
QP245486V4S1	24" x 54" x 86"	89 lbs
QP246086V4S1	24" x 60" x 86"	96 lbs
QP247286V4S1	24" x 72" x 86"	110 lbs

**NEW**

Accessories

**PRODUCT ORGANIZATION**

MODEL NO.	DIMENSIONS W" x H"	SHIP WGT
<b>Millenia Dividers</b>		
QPDIV18	18" x 7-7/8"	1 lb
QPDIV21	21" x 7-7/8"	1 lb
QPDIV24	24" x 7-7/8"	1 lb
<b>Millenia Ledges</b>		
QPL18	18" x 2-1/4"	1 lb
QPL21	21" x 2-1/4"	1 lb
QPL24	24" x 2-1/4"	1 lb
QPL30	30" x 2-1/4"	1 lb
QPL36	36" x 2-1/4"	1 lb
QPL42	42" x 2-1/4"	1 lb
QPL48	48" x 2-1/4"	1 lb
QPL54	54" x 2-1/4"	2 lbs
QPL60	60" x 2-1/4"	2 lbs
QPL72	72" x 2-1/4"	2 lbs

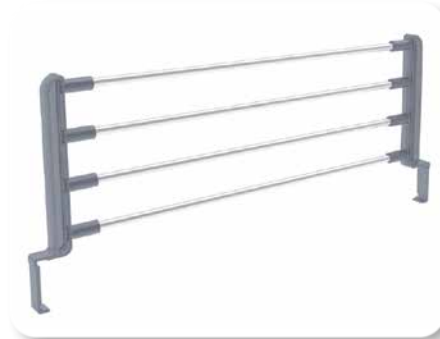

**DIVIDERS**  
QPDIV  
7-7/8" Height

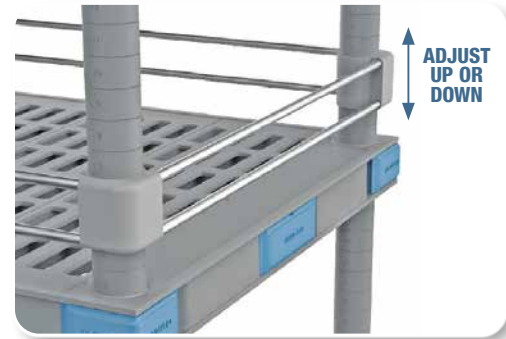

**ADJUSTABLE HEIGHT SIDE AND BACK LEDGE**  
QPL  
2-1/4" Height

**LABEL HOLDERS**

MODEL NO.	DIMENSIONS W"	SHIP WGT
<b>Millenia Label Holders</b>		
QPLH5C	5-1/2" Clear Label Holder	1 lb
QPLH17C	17-1/2" Clear Label Holder Fits 24" Shelf	1 lb
QPLH23C	23-1/2" Clear Label Holder Fits 30" Shelf	1 lb
QPLH29C	29-1/2" Clear Label Holder Fits 36" Shelf	1 lb
QPLH35C	35-1/2" Clear Label Holder Fits 42" Shelf	1 lb
QPLH41C	41-1/2" Clear Label Holder Fits 48" Shelf	1 lb
QPLH47C	47-1/2" Clear Label Holder Fits 54" Shelf	1 lb
QPLH53C	53-1/2" Clear Label Holder Fits 60" Shelf	1 lb
QPLH65C	65-1/2" Clear Label Holder Fits 72" Shelf	1 lb
<b>Millenia Laser and Inkjet Label Inserts - 24 Labels</b>		
QPLHI-3	3" Inserts (Two 8-1/2" x 11" Sheets)	1 lb
QPLHI-5	5-1/2" Inserts (Four 8-1/2" x 11" Sheets)	1 lb



**CLEAR LABEL HOLDER WITH 3" INSERTS**  
QPLH29C + QPLHI-3

**MOBILE APPLICATIONS**



**MOBILE KIT**  
QPPSC-5S

Includes four 5"x1-1/4" Polymer swivel casters, 2 with brake and four donut bumpers. Up to 800 lb. mobile load capacity (evenly distributed)

**ADD-ON UNIT CAPABILITY**



**S-HOOK FOR SIDE BY SIDE CONFIGURATION**  
QP-S-HOOK  
(Sold as 8-pack)



**S-HOOK FOR "L" AND "U" SHAPE CONFIGURATION**  
QP-S-HOOK + QP-S-HOOKL  
(Sold as 8-pack) (Sold as 4-pack)



**CORNER COVER ADAPTER**  
QP-ADC  
Must be purchased with all Add-On units  
(Sold as 8-pack)

**NEW**

Accessories

**WEIGHT SUPPORT**

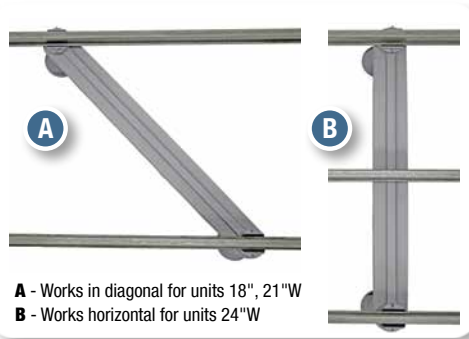

**DUNNAGE SUPPORT STAND\*  
QPDS**

Allows for additional weight and stability  
*\*Extra reinforcement dunnage stand recommended for units with 54" and longer shelves*

**WALL BRACKET  
QP-WMB**

Used to hold a shelf unit from tipping over (Sold as 2-pack)  
*\*Recommended for stationary units only*

**Millenia Platforms**



All platform units consist of 1 shelf and 4 14" posts. **Color:** Gray

MODEL NO.	NOMINAL DIMENSIONS W" x L" x H"	SHIP WGT
<b>Millenia Vented Platforms</b>		
QP183614VP	18" x 36" x 14"	12 lbs
QP184814VP	18" x 48" x 14"	14 lbs
QP186014VP	18" x 60" x 14"	16 lbs
QP243614VP	24" x 36" x 14"	15 lbs
QP244814VP	24" x 48" x 14"	17 lbs
QP246014VP	24" x 60" x 14"	20 lbs
<b>Millenia Solid Platforms</b>		
QP183614SP	18" x 36" x 14"	13 lbs
QP184814SP	18" x 48" x 14"	15 lbs
QP186014SP	18" x 60" x 14"	17 lbs
QP243614SP	24" x 36" x 14"	16 lbs
QP244814SP	24" x 48" x 14"	19 lbs
QP246014SP	24" x 60" x 14"	22 lbs

**Up to 1,000 lb.  
LOAD CAPACITY**

**VENTED PLATFORM  
QP243614VP**

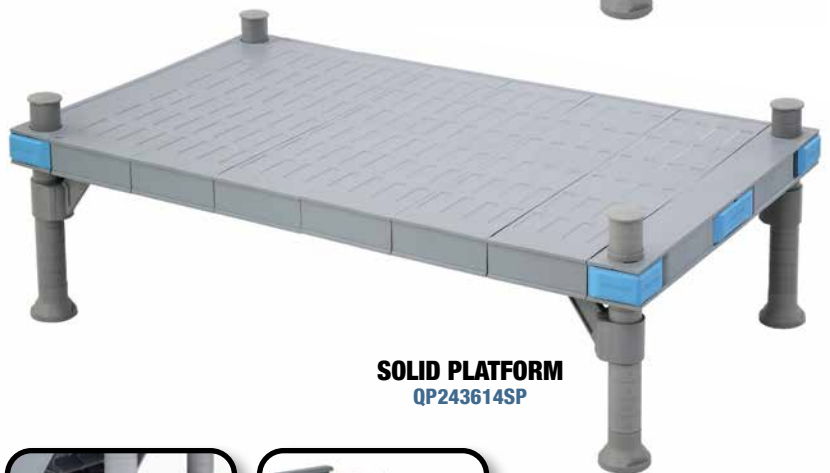

**SOLID PLATFORM  
QP243614SP**

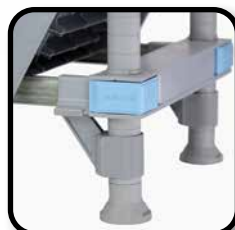

**GUSSETS  
QPG**  
 Included with all shelves  
 for extra support  
 (Sold as 4-pack)

Millenia Drying Racks



BUILT FOR EFFICIENT AND CONVENIENT DRYING

Drying racks allow items to be spread out reducing the risk of mold and bacteria growth. All drying rack complete units include 4 shelf frames with corresponding cradles or shelf plates, 4 posts and mobile kit.

MODEL NO.	NOMINAL DIMENSIONS W" x L" x H"	SHIP WGT
<b>Millenia Universal Drying Racks</b>		
QPM243068DR	24" x 30" x 68"	58 lbs
QPM244268DR	24" x 42" x 68"	67 lbs
QPM245468DR	24" x 54" x 68"	78 lbs
<b>Millenia Pronged Drying Racks</b>		
QPM243068PDR1	24" x 30" x 68"	54 lbs
QPM244268PDR1	24" x 42" x 68"	62 lbs
QPM245468PDR1	24" x 54" x 68"	70 lbs
QPM243068PDR2	24" x 30" x 68"	62 lbs
QPM244268PDR2	24" x 42" x 68"	74 lbs
QPM245468PDR2	24" x 54" x 68"	86 lbs
<b>Millenia Waved Drying Racks</b>		
QPM243068WDR	24" x 30" x 68"	62 lbs
QPM244268WDR	24" x 42" x 68"	74 lbs
QPM245468WDR	24" x 54" x 68"	86 lbs



PRONGED DRYING RACK COMPLETE UNITS  
QPM244268PDR2



WAVED DRYING RACK COMPLETE UNITS  
QPM244268WDR



UNIVERSAL DRYING RACK COMPLETE UNITS  
QPM244268DR



SANITATION WITH DURABILITY



SHELF FRAMES  
QP2430F  
QP2442F  
QP2454F

Shelf frames are needed in order to use drying cradles.

DRYING CRADLES

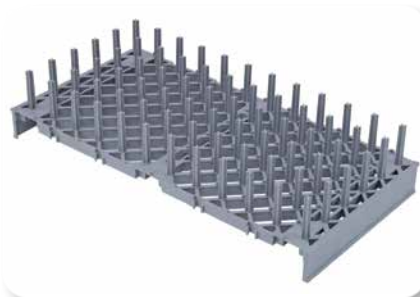

PRONGED DRYING CRADLE  
QPDR1

Easily attaches to shelf frames. Perfect for dishes, drying cups, glassware, or trays. 1-1/2" spacing between each 2-3/4"H prong.



PRONGED DRYING CRADLE  
QPDR2

Easily attaches to shelf frames. Perfect for dishes, drying cups, glassware, or trays. 2-1/2" spacing between each 2-3/4"H prong.



WAVED DRYING AND STORAGE CRADLE  
QPWDR

Easily attaches to shelf frames. Perfect for drying dishes and flat boards.

**1 Box Millenia Vented Shelf Units**



**NEW**

Vented shelves allows for storage from small to large items. Open grid surface allows for air circulation and minimal dust buildup. All vented complete shelf units consist of 4 shelves and 4 posts. Mobilize starter kit shelving unit using optional mobile kit. **Color:** Gray



**OPTIONAL MOBILE KIT**  
**QPPSC-5S**

Includes four 5"x1-1/4" Polymer swivel casters, 2 with brake and four donut bumpers. Up to 800 lb. mobile load capacity (evenly distributed)



**4 SHELF UNIT**

MODEL NO.	DIMENSIONS W" x L" x H"	SHIP WGT
<b>Millenia One Box Shelving</b>		
QP182474VS-4	18" x 24" x 74"	35 lbs
QP183074VS-4	18" x 30" x 74"	39 lbs
QP183674VS-4	18" x 36" x 74"	43 lbs
QP184274VS-4	18" x 42" x 74"	46 lbs
QP184874VS-4	18" x 48" x 74"	50 lbs
QP212474VS-4	21" x 24" x 74"	36 lbs
QP213074VS-4	21" x 30" x 74"	41 lbs
QP213674VS-4	21" x 36" x 74"	45 lbs
QP214274VS-4	21" x 42" x 74"	49 lbs
QP214874VS-4	21" x 48" x 74"	54 lbs
QP242474VS-4	24" x 24" x 74"	43 lbs
QP243074VS-4	24" x 30" x 74"	48 lbs
QP243674VS-4	24" x 36" x 74"	54 lbs
QP244274VS-4	24" x 42" x 74"	59 lbs
QP244874VS-4	24" x 48" x 74"	65 lbs

**PERFORMANCE FEATURES:**

**NSF**

- Lifetime limited warranty against rust and corrosion
- Up to 1,000 lb. load capacity per shelf
- Extremely versatile and suitable for wet, humid and dry environments
- Polymer composition makes it resistant to abrasive chemicals and salt water with built-in antimicrobial protection
- Shelves can be adjusted on 1" increments with no special tool required
- NSF Approved



**▶ SUPER LOW PRICE**

**▶ SUPER LOW TRANSIT COST**

**▶ SINGLE BOX SHIPMENT**

**INSIDE EACH SINGLE BOX UNIT**

- 4 - vented shelves
- 4 - posts (6 pieces each)
- 4 - floor adapters
- 4 - post caps
- 1 - pack (16 sets of split sleeves)
- 1 - pack (16 gussets)



**POST**  
**QPP14**



**CAP**  
**QPPC**



**SPLIT SLEEVES**  
**QPSS**



**FLOOR ADAPTER**  
**QPFA**



**GUSSET**  
**QPG**



**VENTED SHELF**  
**QP1836VS**

**Up to 1,000 lb.**  
**LOAD CAPACITY**  
**PER SHELF**

**Hamper**

Single bag hamper offers foot activated metal heavy-duty lid for quick accessibility. Double ring bag holder allows for quick bag insertion and bag lock. Supports 36-42 gallon multi-purpose bags with a ring to keep bag in place. Four 3" casters (2 with brake) allows for easy mobility. **Finish:** Chrome

MODEL NO.	DIMENSIONS W" x L" x H"	SHIP WGT
<b>18-M-HAMP</b>	20" x 18" x 38"	21 lbs



**Up to 36-42 GAL. CAPACITY**

**Sterile Wrap Carts**

Hang bars keep sterile wraps separated and accessible for special preps. Bars are easy to adjust. Neoprene gaskets hold wraps in position. Two designs to choose from: cascading or low profile. **Finish:** Chrome

MODEL NO.	DIMENSIONS W" x L" x H"	SHIP WGT
<b>Cascading, Sterile Wrap Cart</b>		
<b>WRC-SW2448</b>	24" x 48" x 69"	103 lbs
<b>WRC-SW2460</b>	24" x 60" x 69"	110 lbs
<b>Low Profile, Sterile Wrap Cart</b>		
<b>WRC-LPSW1863</b>	18" x 63" x 39-1/2"	46 lbs

**CARTS INCLUDE CASTER KIT FOR MOBILITY**

**Up to 1,200 lb. MOBILE LOAD CAPACITY**

**TWO DESIGNS AVAILABLE**



**LOW PROFILE**

**WRC-LPSW1863**



**CASCADING**

**WRC-SW2448**



**WRSC3-42-2436FS**  
24"W x 36"L x 48"H



**WRSC4-54-2436FS**  
24"W x 36"L x 60"H

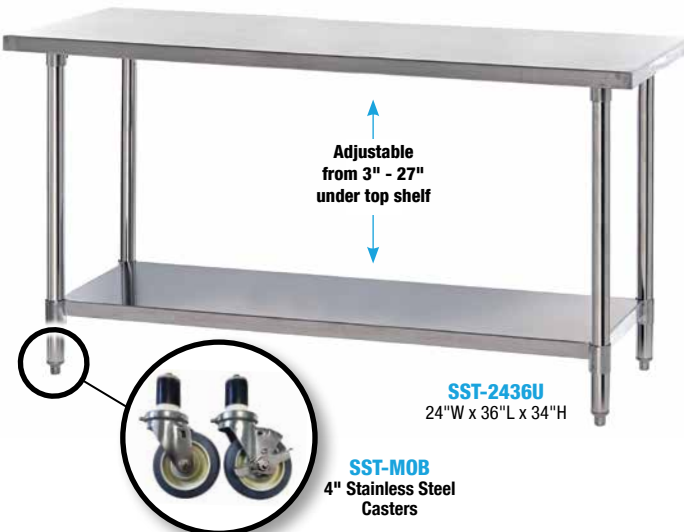

Adjustable  
from 3" - 27"  
under top shelf

**SST-2436U**  
24"W x 36"L x 34"H

**SST-MOB**  
4" Stainless Steel  
Casters

### Open Surgical Case Carts

Corrosion-free surgical case cart transports and delivers surgical instrumentation packs from the OR supply center to the operating room. **Finish:** 304 Stainless Steel

Each unit consists of:

- 4 - 42" stainless steel posts
- 2 - stainless steel wire shelves
- 1 - stainless steel solid shelf
- 1 - stainless steel 3-sided frame
- 1 - stainless steel push handle
- 4 - 5" swivel, stainless steel thermoplastic resin casters, 2 with brakes (casters come with Zerk grease fittings)

### 3 Sided Frames

**Finish:** 304 Stainless Steel

STAINLESS MODEL NO.	DIMENSIONS W" x L"	SHIP WGT
<b>2436FS</b>	24" x 36"	8 lbs
<b>2448FS</b>	24" x 48"	9 lbs
<b>2460FS</b>	24" x 60"	10 lbs

MODEL NO.	DIMENSIONS W" x L" x H"	NO. OF SHELVES	SHIP WGT
<b>WRSC3-42-2436FS</b>	24" x 36" x 48"	3	77 lbs
<b>WRSC3-42-2448FS</b>	24" x 48" x 48"	3	88 lbs
<b>WRSC3-42-2460FS</b>	24" x 60" x 48"	3	106 lbs

### CARTS INCLUDE CASTER KIT FOR MOBILITY

**Up to 1,200 lb.**  
MOBILE LOAD CAPACITY

Each unit consists of:

- 4 - 54" stainless steel posts
- 3 - stainless steel wire shelves
- 1 - stainless steel solid shelf
- 1 - stainless steel 3-sided frame
- 1 - stainless steel push handle
- 4 - 5" swivel, stainless steel thermoplastic resin casters, 2 with brakes (casters come with Zerk grease fittings)

MODEL NO.	DIMENSIONS W" x L" x H"	NO. OF SHELVES	SHIP WGT
<b>WRSC4-54-2436FS</b>	24" x 36" x 60"	4	94 lbs
<b>WRSC4-54-2448FS</b>	24" x 48" x 60"	4	108 lbs
<b>WRSC4-54-2460FS</b>	24" x 60" x 60"	4	131 lbs

**Up to 650 lb.**  
LOAD CAPACITY PER SHELF

### Stainless Steel Work Tables with Adjustable Undershelf



Heavy-duty 304 stainless steel processing tables are ideal for pack and prep in sterile environments. Units consist of a flat top work surface with hemmed edges and the lower flat bottom shelf is adjustable from 3" to 27" high. Tables are NSF approved. The support legs are 1-5/8" diameter with a leveling foot which can be converted to a mobile unit with a 4" stainless steel caster kit, all swivel and 2 with brake. (Sold separately) **Finish:** 304 Stainless Steel

MODEL NO.	DIMENSIONS W" x L" x H"	NO. OF SHELVES	SHIP WGT
<b>Stationary Instrument Table with Shelf</b>			
<b>SST-2436U</b>	24" x 36" x 34"	1	50 lbs
<b>SST-2448U</b>	24" x 48" x 34"	1	60 lbs
<b>SST-2460U</b>	24" x 60" x 34"	1	70 lbs
<b>SST-2472U</b>	24" x 72" x 34"	1	80 lbs
<b>Mobile Kit</b>			
<b>SST-MOB</b>	4 Swivel Casters, 2 with Brake		4 lbs

**Catheter Cart - Complete with Bins**

Uniquely designed, the catheter bin cart replaces the wire basket concept with color coded bins allowing for quicker identification. The combination of modular wire and plastic bins minimizes shrinkage and reduces unit cost. Bins are molded from high density polypropylene and are available in 7 colors. **Cart Finish:** Chrome

**Bins available in:** ● Blue ● Green ● Ivory ● Red ● Yellow ● Black  
● Clear (One color per unit)

MODEL NO.	BIN DIMENSIONS L" x W" x H"	SHIP WGT
<b>24"W x 48"L x 69"H - Wire Catheter Cart with 9 Wire Shelves Complete with 80 QSB105 Bins</b>		
<b>WRC9-63-2448-105</b>	23-5/8" x 4-1/8" x 4"	246 lbs



**WRC9-63-2448-105**

**CARTS INCLUDE CASTER KIT FOR MOBILITY**

**Up to 1,200 lb. MOBILE LOAD CAPACITY**

**CLEAR VIEWS**  
AVAILABLE



**Catheter Hooks**

Package includes 6 catheter hooks. **Finish:** Chrome

MODEL NO.	DESCRIPTION	CTN WGT
<b>Catheter Hooks - 6 Pack</b>		
<b>WR-CH</b>	6 Catheter Hooks	2 lbs

**Catheter Hold & Store Cart**

The catheter hold and store cart allows separation and easy accessibility to pre-packed catheters. Ideal for central or OR supply centers, this style cart is modular in design. Includes 36 or 42 catheter hooks. **Finish:** Chrome

MODEL NO.	DIMENSIONS W" x L" x H"	SHIP WGT
<b>Catheter Hold and Store Cart Includes 36 Catheter Hooks</b>		
<b>WRC-BC2448</b>	24" x 48" x 69"	105 lbs
<b>Catheter Hold and Store Cart Includes 42 Catheter Hooks</b>		
<b>WRC-BC2460</b>	24" x 60" x 69"	125 lbs



**WRC-BC2448**  
Shown with Dividable Grid Containers  
Sold separately on pg. 67



**WRCGR-63-2436**



**RACK AND CART COVERS**

Protect against pilferage, airborne dust, moisture and other contaminants.

**Stationary and Mobile Wire Garment Racks**

Ideal storage rack for hanging any type of coat or garment. Includes handy bottom shelf for additional storage.

**Finish:** Chrome

*Each unit consists of:*

- 4 - 63" posts
- 2 - wire shelves
- 1 - hang bar (up to 75 lb. hang capacity evenly distributed)

*Mobile unit also includes:*

- 4 - 5" swivel thermoplastic resin casters, 2 with brakes
- 4 - donut bumpers

MODEL NO.	DIMENSIONS W" x L" x H"	NO. OF SHELVES	SHIP WGT
<b>Stationary Wire Garment Racks</b>			
<b>WRGR-63-2436</b>	24" x 36" x 63"	2	45 lbs
<b>WRGR-63-2448</b>	24" x 48" x 63"	2	52 lbs
<b>WRGR-63-2460</b>	24" x 60" x 63"	2	63 lbs
<b>Mobile Wire Garment Racks</b>			
<b>WRCGR-63-2436</b>	24" x 36" x 69"	2	59 lbs
<b>WRCGR-63-2448</b>	24" x 48" x 69"	2	66 lbs
<b>WRCGR-63-2460</b>	24" x 60" x 69"	2	77 lbs

**NYLON FABRIC OR CLEAR VINYL RACK AND CART COVERS AVAILABLE**

See pg. 136

**CARTS INCLUDE CASTER KIT FOR MOBILITY**

**Up to 1,200 lb. MOBILE LOAD CAPACITY**



**WRCPL-63-2460**

**Patient Apparel Cart**

Ideal for patient care situations where the distribution and holding of apparel is required. The horizontal bar accommodates hangers and the shelves are divided into separate visible compartments.

**Finish:** Chrome

*Each unit consists of:*

- 4 - 63" posts
- 2 - 54" posts
- 2 - 24"W x 60"L wire shelves
- 3 - 24"W x 36"L wire shelves
- 8 - 24" dividers
- 2 - 61" rods and tabs kits
- 1 - 24" hang bar (up to 75 lb. hang capacity evenly distributed)
- 4 - 5" swivel thermoplastic resin casters, 2 with brakes
- 4 - donut bumpers

MODEL NO.	DIMENSIONS W" x L" x H"	NO. OF SHELVES	SHIP WGT
<b>WRCPL-63-2460</b>	24" x 60" x 69"	5	146 lbs

**Bin Transport Cart**

The combination of bins and modular shelving creates a highly efficient method of visually identifying and transporting multiple items. The large capacity bins allow for color coding and the rotation of inventories. This multi-tasked unit is excellent for a wide variety of applications and transport solutions. **Cart Finish:** Chrome

Each unit consists of:

- 4 - 63" posts
- 2 - 54" posts
- 2 - 24"W x 60"L wire shelves
- 3 - 24"W x 36"L wire shelves
- 4 - 5" swivel thermoplastic resin casters, 2 with brakes
- 4 - donut bumpers
- 4 - QUS955 (23-7/8"L x 18-1/4"W x 12"H)

Bins available in: ● Blue ● Red ● Yellow ● Clear (One color per unit)

MODEL NO.	DIMENSIONS W" x L" x H"	NO. OF BINS	SHIP WGT
WRCPL-63-2460-955	24" x 60" x 69"	4 QUS955	165 lbs

**COMPLETE PACKAGES WITH BINS**



WRCPL-63-2460-955

**CARTS INCLUDE CASTER KIT FOR MOBILITY**

**Up to 1,200 lb. MOBILE LOAD CAPACITY**

**Bin Transport Carts**

Modular in design, the Bin Transport Cart provides an integrated system to transfer items. Carts enable you to color code, hold, or transport inventories and supplies. Ideal for use in central supply and laundry. Bins are autoclavable up to 250°F. **Cart Finish:** Chrome

Bins available in: ● Blue ● Red ● Yellow (One color per unit)

MODEL NO.	NO. OF SHELVES	NO. OF BINS	BIN DIMENSIONS L" x W" x H"	SHIP WGT
<b>30"W x 36"L x 69"H - Wire Shelving Unit with HULK Containers</b>				
WRC2-63-3036-974976	2	2	29-7/8" x 16-1/2" x 11"	150 lbs
		6	29-7/8" x 16-1/2" x 15"	
<b>30"W x 36"L x 42"H - Wire Shelving Unit with HULK Containers</b>				
WRC2-36-3036-976	2	4	29-7/8" x 16-1/2" x 15"	88 lbs



WRC2-63-3036-974976



WRC2-36-3036-976

Polymer Dunnage Racks



Smooth top and rounded edges promote safe handling and protects against product damage. Open surface enables airflow, cleanability, and prevents bacteria buildup. Heavy-duty polymer construction gives racks the strength to hold up to 4,000 lbs. No assembly required. Multiple combinations enable custom storage space layouts. Racks can be loaded/unloaded easily from all sides. Withstands temperatures from -20°F to 180°F. Won't overheat or overcool. Antimicrobial additive protects against rust, corrosion, bacteria, mold, and mildew. Ideal to elevate products off of the floor in coolers, freezers, backrooms, food preparation, and storage areas. Polymer composition makes these racks resistant to rust, corrosion, and food acids. **Color:** Gray

Available in: ● Gray

MODEL NO.	DESCRIPTION	SHIP WGT
<b>Dunnage Racks</b>		
QFSD-2236	22"D x 36"W x 12"H - Dunnage Rack	18 lbs
QFSD-2248	22"D x 48"W x 12"H - Dunnage Rack	24 lbs
QFSD-2260	22"D x 60"W x 12"H - Dunnage Rack	28 lbs

**SAFE  
SANITARY  
STRONG**

**SUPERIOR CHOICE  
AND STRENGTH  
OVER ALUMINUM  
AND OTHER  
TYPE RACKS**

**Up to 2,200 lb.**  
LOAD CAPACITY



QFSD-2236

**Up to 4,000 lb.**  
LOAD CAPACITY



QFSD-2248

**Up to 4,000 lb.**  
LOAD CAPACITY



QFSD-2260

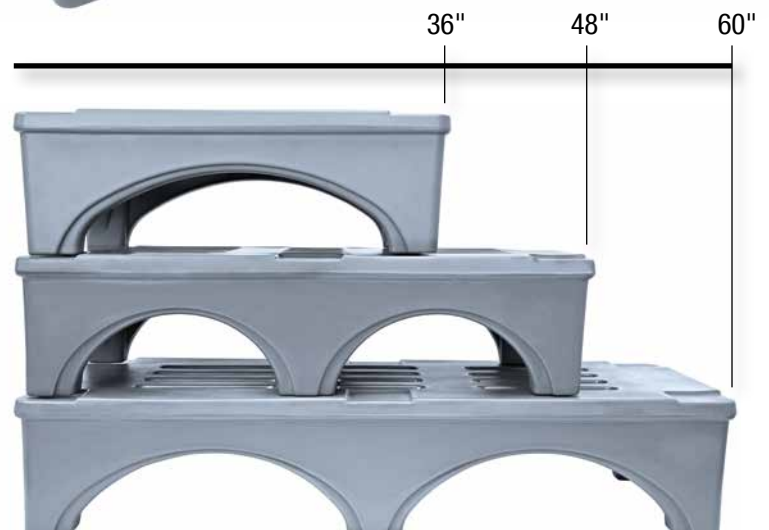

Wine Cradle Wire Shelf



Quantum's NEW Wine Cradle Shelf is a perfect storage solution for wine bottles. Shelves comes in two sizes: a 36"L that holds up to 9 bottles and a 48"L that holds up to 12 bottles. **Finishes:** Chrome and Black Epoxy

Up to **12** BOTTLES PER SHELF



**1436WSC  
1436WSBK**  
Wine Cradle Wire Shelf  
14"W x 36"L



IDEAL STORAGE SOLUTION!

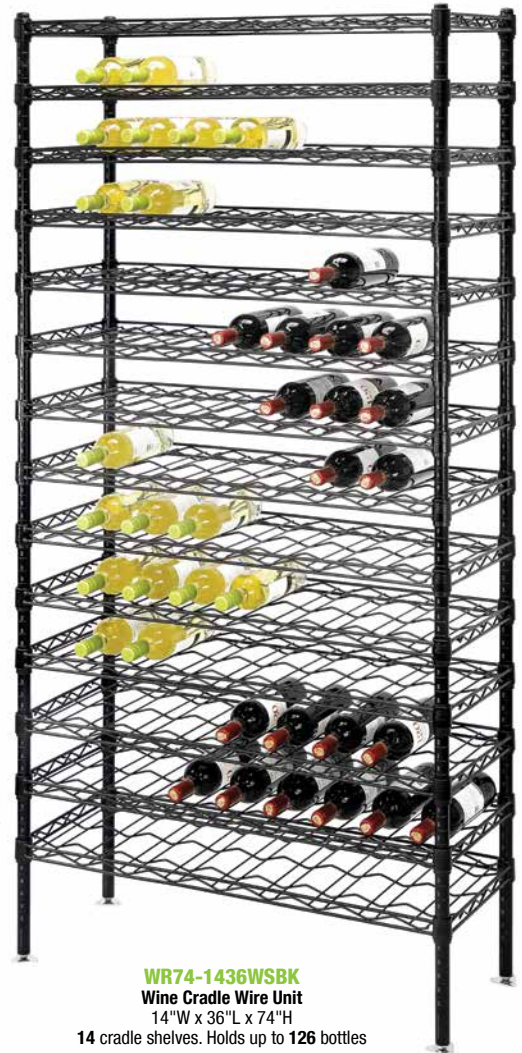

**WR74-1436WSBK**  
Wine Cradle Wire Unit  
14"W x 36"L x 74"H  
14 cradle shelves. Holds up to 126 bottles

Wine Cradle Cart



Excellent mobile storage solution for your wine collection. These carts includes two cradle shelves, a wire or stainless steel top shelf and a bottom wire shelf for additional storage. All units include 4 posts, 4 donut bumpers and 4 casters, 2 with brakes.



**WRC-1436WSBK-1SS**  
Wine Cradle Cart  
14"W x 36"L x 45"H

2 cradle shelves. Holds up to 18 bottles.  
1 stainless steel top shelf. 1 wire bottom shelf.

Wine Cradle Wire Unit



The complete storage solution for your location. This practical unit can be used in most indoor and/or outdoor settings. Units come with up to 17 cradle shelves and can holds up to 204 bottles, includes 4 posts, foot plates and wall brackets.

FINISHES:

- ◆ CHROME C ◆ BLACK EPOXY BK

MODEL NO.	DIMENSIONS W" x L" x H"	SHIP WGT
<b>Wine Cradle Wire Shelves</b>		
1436WSC	14" x 36"	7 lbs
1436WSBK	14" x 36"	7 lbs
1448WSC	14" x 48"	9 lbs
1448WSBK	14" x 48"	9 lbs
<b>Wine Cradle Carts</b>		
WRC-1436WSC	14" x 36" x 45"	53 lbs
WRC-1436WSC-1SS	14" x 36" x 45"	58 lbs
WRC-1436WSBK	14" x 36" x 45"	53 lbs
WRC-1436WSBK-1SS	14" x 36" x 45"	58 lbs
<b>Wine Cradle Wire Units</b>		
WR74-1436WSC	14" x 36" x 74"	120 lbs
WR74-1436WSBK	14" x 36" x 74"	120 lbs
WR86-1436WSC	14" x 36" x 86"	145 lbs
WR86-1436WSBK	14" x 36" x 86"	145 lbs
WR74-1448WSC	14" x 48" x 74"	148 lbs
WR74-1448WSBK	14" x 48" x 74"	148 lbs
WR86-1448WSC	14" x 48" x 86"	179 lbs
WR86-1448WSBK	14" x 48" x 86"	179 lbs



CHROME



EPOXY

PERFORMANCE FEATURES:

- Assembles in minutes
- Wire design allows for air circulation and minimal dust buildup
- Shelves easily adjust on 1" centers to your exact needs
- 1 year limited warranty on Chrome and 15 year limited warranty on Black Epoxy
- Includes posts, shelves, and all needed hardware
- No tools required

**Wine Cantilever Systems**



Versatile adjustable post wall-mount system, perfect for maximizing storage in challenging areas alongside floor storage. Offered in both single and double configurations, capable of accommodating up to 96 bottles. **Finishes:** Chrome and Black Epoxy

SINGLE MODEL NO.	DIMENSIONS L" x H"	SHIP WGT
<b>14" W Single Wine Cantilever System</b>		
WC14-1436WC	36" x 14"	16 lbs
WC14-1448WC	48" x 14"	19 lbs
WC34-1436WC-2	36" x 34"	31 lbs
WC34-1448WC-2	48" x 34"	36 lbs
WC34-1436WC-3	36" x 34"	42 lbs
WC34-1448WC-3	48" x 34"	52 lbs
WC54-1436WC-4	36" x 54"	60 lbs
WC54-1448WC-4	48" x 54"	70 lbs
<b>14" W Double Wine Cantilever System</b>		
WC14-1436WC-2	72" x 14"	35 lbs
WC14-1448WC-2	96" x 14"	51 lbs
WC34-1436WC-4	72" x 34"	61 lbs
WC34-1448WC-4	96" x 34"	79 lbs
WC34-1436WC-6	72" x 34"	100 lbs
WC34-1448WC-6	96" x 34"	115 lbs
WC54-1436WC-8	72" x 54"	135 lbs
WC54-1448WC-8	96" x 54"	155 lbs



Wine Cradle shelves can be adjusted on a 1" increments.

**Wine Bulk Shelving**



Allows for storing a substantial wine collection within a confined area. Angles bottles at a 10° incline to preserve cork moisture. The open-wire design facilitates airflow, crucial for temperature regulation. Each unit is enclosed by rear and side panels to ensure bottle security and prevent accidents. **Finishes:** Chrome and Black Epoxy

MODEL NO.	DIMENSIONS W" x L" x H"	SHIP WGT
<b>74" W Wine Bulk Shelving</b>		
WR74-BW1436C	14" x 36" x 74"	140 lbs
WR74-BW1448C	14" x 48" x 74"	170 lbs

**FINISHES:**

- ◆ CHROME C ◆ BLACK EPOXY BK

**REPLACE SUFFIX "C" WITH "BK" IN MODEL NO. TO ORDER BLACK EPOXY FINISH**

Ex. WC34-1436WBK-2 WR74-BW1436BK



**WR74-BW1436BK**  
Wine Bulk Shelving  
14"W x 36"L x 74"H



**QUICK, EASY ASSEMBLY**



**WC34-1436WBK-4**  
Wine Cantilever System  
72"L x 34"H

**Wine Wire Security Units**



Security units prevent pilferage while allowing high visibility of contents at all times. All side and back panels are heavy gauge wire construction and are manufactured of all-welded heavy-duty 1/4" diameter wire on 2" x 2" centers. Assembly is quick and easy. **Finishes:** Chrome and Black Epoxy

**ADD SUFFIX "BK" TO MODEL NO. TO ORDER BLACK EPOXY FINISH**

Ex. 1436-74BWSECBK

MODEL NO.	DIMENSIONS W" x L" x H"	SHIP WGT
<b>74" Stationary Bulk</b>		
1436-74BWSEC	14" x 36" x 74"	202 lbs
1448-74BWSEC	14" x 48" x 74"	244 lbs
<b>74" Stationary Mixed</b>		
1436-74MIXSEC	14" x 36" x 74"	210 lbs
1448-74MIXSEC	14" x 48" x 74"	252 lbs
<b>69" Mobile Bulk</b>		
M1436-69BWSEC	14" x 36" x 69"	205 lbs
M1448-69BWSEC	14" x 48" x 69"	246 lbs
<b>69" Mobile Mixed</b>		
M1436-69MIXSEC	14" x 36" x 69"	213 lbs
M1448-69MIXSEC	14" x 48" x 69"	254 lbs



**M1436-69MIXSEC**  
Wine Wire Security Cart  
14"W x 36"L x 69"H

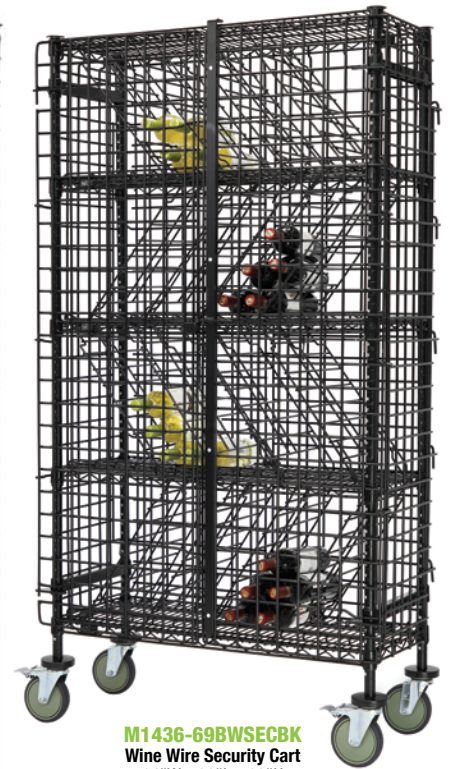

**M1436-69BWSECBK**  
Wine Wire Security Cart  
14"W x 36"L x 69"H

Mobile Ingredient Organizer



Ideal for combining work station and storage on the go.

Bins available in: ● Blue ● Green ● Ivory ● Red ● Yellow ● Black ● Clear

MODEL NO.	DIMENSIONS W" x L" x H"	NO. OF BINS	SHIP WGT
WRC-CC1430GY	14" x 30" x 33"	12	64 lbs
WRC-CC1436GY	14" x 36" x 33"	18	76 lbs
WRC-CC1830GY	18" x 30" x 33"	12	69 lbs
WRC-CC1836GY	18" x 36" x 33"	18	80 lbs

(One color per unit)

Each unit consists of:

- 4 - 27" cut posts
- 1 - wire shelf
- 1 - solid stainless shelf
- 3 - bin rail holders
- 4 - donut bumpers
- 4 - 5" thermoplastic resin casters, 2 with brakes

(Quantity of QUS230 bins listed in chart above)



Countertop Ingredient Organizer



Ideal for serving areas and lunch rooms, minimizing clutter on the counter.

Bins available in: ● Blue ● Green ● Ivory ● Red ● Yellow ● Black ● Clear

MODEL NO.	DIMENSIONS W" x L" x H"	NO. OF BINS/DIVIDERS	SHIP WGT
CT27-1824GY-230	18" x 24" x 27"	12	40 lbs
CT27-1830GY-230	18" x 30" x 27"	16	53 lbs
CT27-1836GY-230	18" x 36" x 27"	24	59 lbs

(One color per unit)

Each unit consists of:

- 2 - 27" cut posts
  - 2 - 6" posts
  - 1 - 3 sided frame
  - 4 - bin rail holders
- (Quantity of QUS230 bins and dividers listed in chart above)



Custom Drive-thru Station



To create this exact drive-thru station unit you would need to purchase the following parts listed below.

Unit consists of:

- 2 - 74" Post - P74P
- 2 - 34" Post - P34P
- 1 - 24" x 36" Solid Shelf - 2436SG
- 3 - 24" x 36" Wire Shelf - 2436P
- 2 - 18" x 36" Wire Grid - SG-1836P
- 2 - Post Mount Grid Bracket (Pack of 4) - WR-PMGP
- 1 - 14" x 36" Shelf - SG-LS1436P
- 5 - Ultra Bins - QUS230CL\*
- 5 - Single Bin Holder - SG-SBH
- 3 - Ultra Bins - QUS235CL\*
- 3 - Small Bin Holder - SG-SMBH

\*Plastic bins must be purchased in carton quantities

STORAGE AND ORGANIZATION AT YOUR FINGERTIPS



DRIVE-THRU STATION



WR-PMGP Post Mount Grid Bracket See pg. 166

# QUICK AND EASY INSTALLATION

**NEW**



**2430SSTOP**  
Stainless Steel Shelf Cover

Foam barrier included providing protective cushioning and helps muffle noise

## Stainless Steel Shelf Covers

**NSF**

Constructed from durable 18 gauge 304 stainless steel, this stainless steel shelf covering offers commercial-grade resilience, engineered for extended durability. Unlike wire shelving that may permit small items to slip through or pose the risk of package leaks affecting lower shelves, this sturdy shelf covering transforms wire shelves into functional workstations, providing the versatility and dependability essential for a range of applications.

MODEL NO.	DIMENSIONS W" x L" x H"	SHIP WGT
<b>2430SSTOP</b>	24" x 30" x 2"	20 lbs
<b>3030SSTOP</b>	30" x 30" x 2"	27 lbs
<b>3036SSTOP</b>	30" x 36" x 2"	27 lbs
<b>3042SSTOP</b>	30" x 42" x 2"	28 lbs
<b>3048SSTOP</b>	30" x 48" x 2"	28 lbs
<b>3060SSTOP</b>	30" x 60" x 2"	29 lbs
<b>3072SSTOP</b>	30" x 72" x 2"	30 lbs

## Custom Stations

**NSF**

Preconfigured custom station starter unit is available in 36", 48" and 60" lengths. Customize your prep or drive-thru station as needed with optional accessories shown on **pgs. 153-154**.

MODEL NO.	DIMENSIONS W" x L" x H"	SHIP WGT
<b>WR74-DT2436P</b>	24" x 36" x 74"	84 lbs
<b>WR74-DT2448P</b>	24" x 48" x 74"	103 lbs
<b>WR74-DT2460P</b>	24" x 60" x 74"	126 lbs

Each unit consists of:

- 2 - 74" Post
- 2 - 34" Post
- 1 - Solid Shelf
- 2 - Wire Shelf
- 2 - Wire Grid
- 2 - Post Mount Grid Bracket (Pack of 4)
- 1 - Cantilever Shelf

**NEW**

**OPTIONAL  
ACCESSORY  
PACKS AND  
ACCESSORIES  
AVAILABLE**

See **pg. 153-154**

**DISPLAY,  
ORGANIZE,  
SAVE SPACE**

**MAXIMIZE  
EFFICIENCY**



**WR74-DT2436P**

## UNIT SHOWN IS CUSTOMIZABLE USING A VARIETY OF ACCESSORIES



**WR74-DT2436P + SG-A2BL**

Drying Rack - 4 Shelf Units

**NEW**

Drying rack allows you to store and dry cutting boards, trays and pans. All units come with 2 cutting board/tray and 2 pan drying racks. **Finish:** Proform Green/Gray Epoxy

MODEL NO.	DIMENSIONS W" x L" x H"	SHIP WGT
<b>Complete Drying Rack Units</b>		
M2436W46DR	24" x 36" x 63"	134 lbs
M2448W46DR	24" x 48" x 63"	162 lbs
M2460W46DR	24" x 60" x 63"	194 lbs



**MOBILIZE YOUR WIRE SHELVING**

**DB - Donut Bumper**  
Non-marking donut bumper used to protect walls and help cushion impact.

**WR-00H (Mobile Kit)**  
Set of four swivel thermoplastic resin 5" x 1-1/4" casters, two with brakes. Can be used with all units shown. Up to 1,200 lb. load capacity.



**M2448W46DR**  
Green Polymer and Gray Epoxy Finish

**FITS FROM 24-43 TRAYS PER RACK**

**FITS FROM 10-17 PANS PER RACK**

Can Rack - 4 Shelf Units

**NEW**

Can rack is front-loading, front-dispensing. 36" unit come with 4 can racks per shelf, 48" unit come with 5 can racks per shelf. **Finish:** Proform Green/Gray Epoxy

MODEL NO.	DIMENSIONS W" x L" x H"	SHIP WGT
<b>Complete Can Rack Units</b>		
WR74-CR2436WPM	24" x 36" x 74"	152 lbs
WR74-CR2448WPM	24" x 48" x 74"	181 lbs

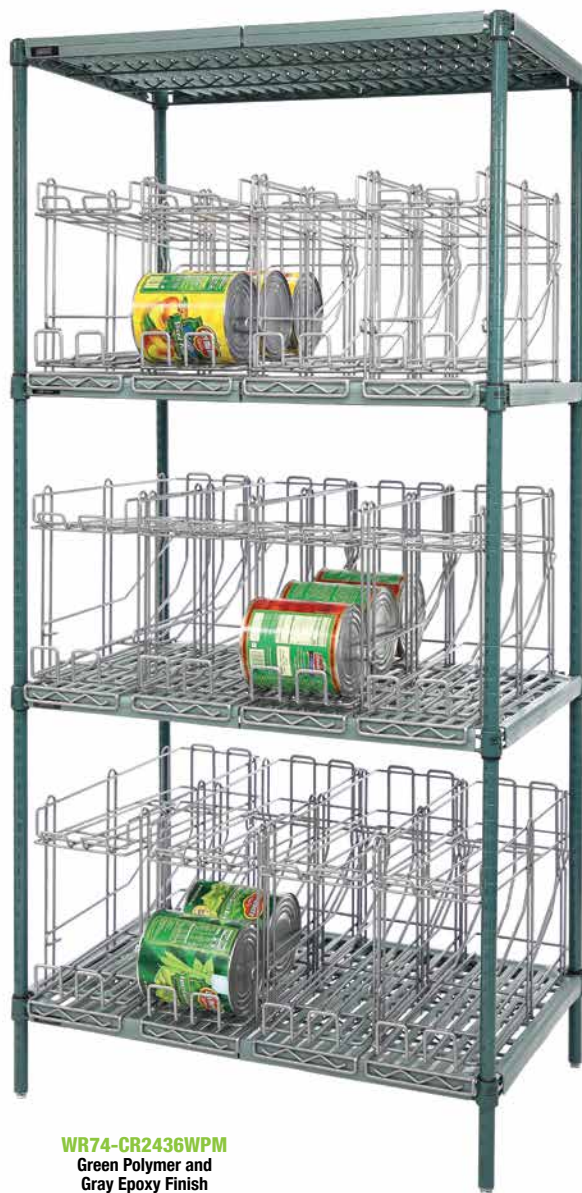

**WR74-CR2436WPM**  
Green Polymer and Gray Epoxy Finish

**FITS FROM 8-#10 OR 12-#5 CANS PER RACK**

**S-Hooks**

For continuous runs of shelving. Two hooks should be used per shelf where two posts are not utilized. Sold as an 8 pack.  
**Finish:** Proform Green/Stainless Steel



**S-HOOKWPM**  
Proform Green Epoxy/  
Stainless Steel



**Label Holder**



**ULH3C**  
Label Holder  
1-3/8" x 3"  
Other length sizes  
**ULH33C** 33"  
**ULH45C** 45"  
**ULH57C** 57"  
**ULH69C** 69"

**EASY IDENTIFICATION OF AISLES/ROWS CONTENTS**

**Post Label Holders**

New post label holders come in two sizes and allow for easy identification of aisles/rows as well as of wire cart contents. Attach to standard 1" diameter posts. Each package includes 12 clear holders and corresponding printer friendly sheet labels.

MODEL NO.	DIMENSIONS W" x L"	PKG QTY	SHIP WGT
<b>PLH1X6C</b>	1" x 6"	12 pcs	1 lb
<b>PLH2X4C</b>	2" x 4"	12 pcs	1 lb



**PLH1X6C**  
Post Label  
1" x 6"



**PLH2X4C**  
Post Label  
2" x 4"

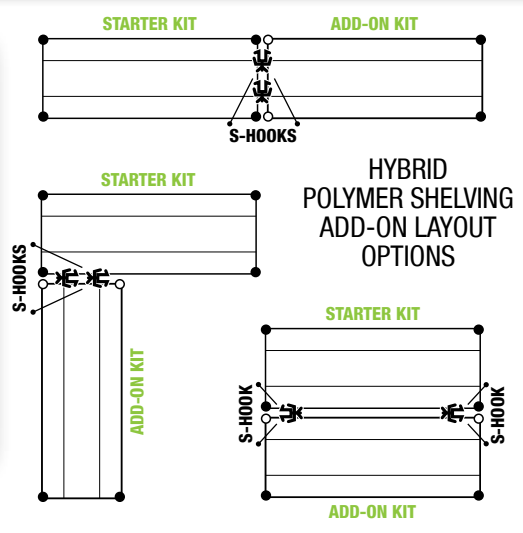

**Tray/Pan Drying Racks**



Drying rack allow you to store and dry cutting boards, trays and pans. Rack fits on 24" deep shelves fitting up to 43 trays or 17 pans per rack. **Finish:** Gray Epoxy

MODEL NO.	DIMENSIONS W" x L" x H"	TRAYS/PANS CAP	SHIP WGT
<b>Cutting Board/Tray Drying Racks 1-1/8" Spacing</b>			
<b>TDR24361GY</b>	24" x 36" x 8"	24	15 lbs
<b>TDR24481GY</b>	24" x 48" x 8"	34	21 lbs
<b>TDR24601GY</b>	24" x 60" x 8"	43	26 lbs
<b>Pan Drying Racks 3" Spacing</b>			
<b>TDR24363GY</b>	24" x 36" x 8"	10	11 lbs
<b>TDR24483GY</b>	24" x 48" x 8"	14	15 lbs
<b>TDR24603GY</b>	24" x 60" x 8"	17	18 lbs

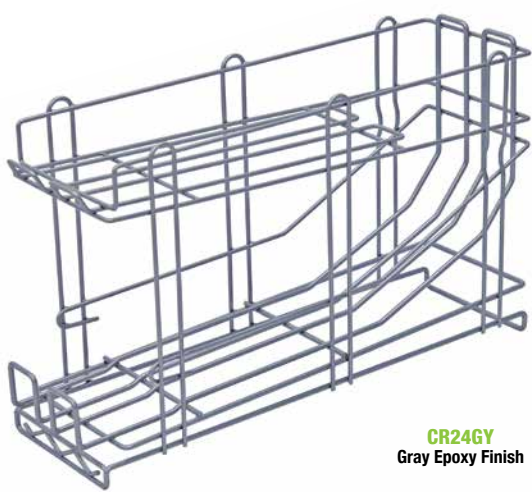

**CR24GY**  
Gray Epoxy Finish

**NEW**

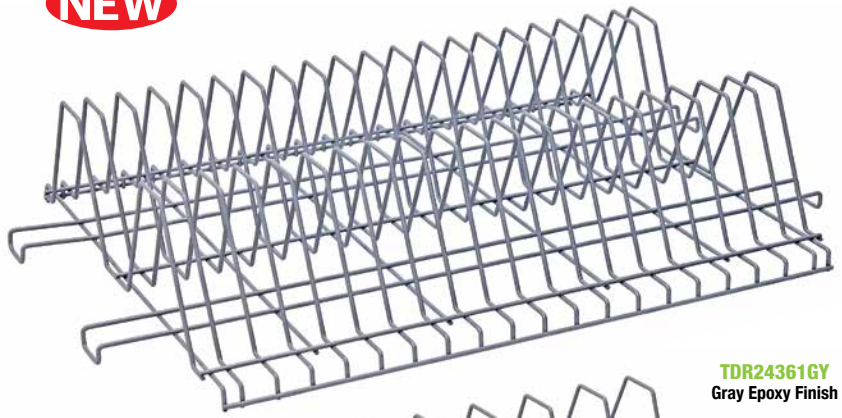

**TDR24361GY**  
Gray Epoxy Finish

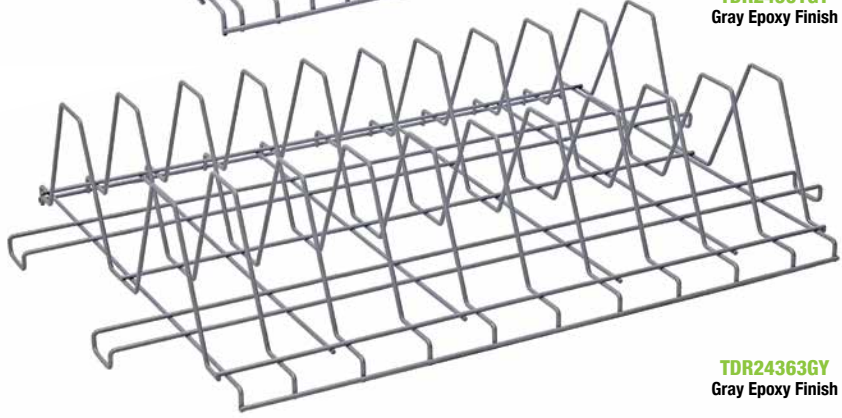

**TDR24363GY**  
Gray Epoxy Finish

**Can Racks**



Can rack is front-loading, front-dispensing. Each rack fits on 24" deep shelves and can fit from 8#10 or 12#5 cans per rack. **Finish:** Gray Epoxy

MODEL NO.	DIMENSIONS W" x L" x H"	SHIP WGT
<b>Can Racks</b>		
<b>CR24GY</b>	25-1/2" x 8" x 15"	9 lbs

Crusader Round Trash Cans



Our heavy-duty CRUSADER Round Trash Cans feature a proprietary design crafted from premium polymer resin, including a UV inhibitor, ensuring durability and longevity, even in the harshest commercial and industrial environments.

Available in: ● Gray ● Red ● Yellow ● Black ○ White ● Custom

MODEL NO.	DIMENSIONS DIA" x H"	CAP GAL.	SHIP WGT	LID	SHIP WGT
CTC-10	15.6" x 17.3"	10 gal.	4 lbs	CTC-L10	1 lb
CTC-20	19.5" x 22.9"	20 gal.	6 lbs	CTC-L20	2 lbs
CTC-32	22.0" x 27.3"	32 gal.	8 lbs	CTC-L32	2 lbs
CTC-44	24.0" x 31.5"	44 gal.	10 lbs	CTC-L44	3 lbs
CTC-55*	26.4" x 33.0"	55 gal.	14 lbs	CTC-L55*	3 lbs

Diameter shown is for top outside rim. \*Available only in Gray or Black colors  
**CUSTOM COLORS AVAILABLE** call for details

# HEAVY-DUTY



ULTRA HEAVY-DUTY EASY-GRIP HANDLE



VENTING CHANNELS TO ALLOW EASY RELEASE OF GARBAGE BAG + AIR CIRCULATION



REINFORCED HEAVY-DUTY BASE WITH CONTOURED HANDLE



LID  
 CTC-L55  
 (Sold separately)

**NEW**

ROUND TRASH CAN  
 CTC-55



**10**  
**GALLONS**



**20**  
**GALLONS**



**32**  
**GALLONS**

5 COLORS AVAILABLE



TWIST LOCK DESIGN ENSURES TRASH CANS FIT TIGHT AND SECURE



GRAY

RED

YELLOW

BLACK

WHITE

QUIET DOLLY

CTC-DLY

18" DIA x 6" H  
5 swivel 3" x 1" thermoplastic rubber casters (non-marking/silent). Ensures effortless transport and quiet movement over all surfaces when handling facility waste.

Up to 1,000 lb. MOBILE LOAD CAPACITY



44 GALLONS



55 GALLONS

Crusader Thin Trash Cans



The CRUSADER Thin Trash Cans are ideal for confined spaces boasting unmatched performance and a proprietary design with venting channels and bag cinches. Its compact, high-quality construction ensures durability in extreme commercial conditions.

Available in: ● Gray ● Black ● Brown ● Custom

MODEL NO.	DIMENSIONS L" X W" X H"	CAP GAL.	SHIP WGT
CTH-16	22" x 11" x 25"	16 gal.	7 lbs
CTH-23	22" x 11" x 30"	23 gal.	8 lbs

CUSTOM COLORS AVAILABLE call for details



**DROP SHOT LID**  
CTH-LDS  
Keeps garbage out of sight and allows no-touch access.



**THIN TRASH CAN**  
CTH-16



VENTING CHANNELS



BAG CINCHES



BASE AND RIM HANDLES



STURDY EASY-GRIP HANDLE

**MOBILE KIT**  
CTH-MOB

4 swivel 3" x 1" thermoplastic rubber casters (non-marking/silent) and 2 connectors.

**DOLLY**  
CTH-DLY

4 swivel 3" x 1" thermoplastic rubber casters (non-marking/silent).

**NEW**

**3 COLORS AVAILABLE**



**Up to 250 lb.**  
LOAD CAPACITY



**Up to 800 lb.**  
LOAD CAPACITY



GRAY



BLACK



BROWN



**Crusader Thin Recycling Containers**

The CRUSADER Thin Recycling Container is a versatile solution designed to combine a sleek, front-of-house appearance with practical, smart functionality. Its modern design makes it a great fit for areas that experience high foot traffic, such as lobbies and breakrooms. This adaptable recycling container not only enhances the aesthetic nature of these spaces but also ensures efficient waste sorting and management.

Available in: ● Blue ● Green

MODEL NO.	DIMENSIONS L" X W" X H"	CAP GAL.	SHIP WGT
CTH-23R	22" x 11" x 30"	23 gal.	8 lbs



**ALWAYS  
KEEP IT  
CLEAN**



BLUE

**NEW**



GREEN

**THIN RECYCLING  
CONTAINER**  
CTH-23R



**CAN / BOTTLE LID**  
CTH-LCB



**MIXED RECYCLE LID**  
CTH-LMX



**PAPER LID**  
CTH-LPA



**FLAT LID**  
CTH-LFT



**FLAT LID W/ HANDLE**  
CTH-LHFT

**2 COLORS  
AVAILABLE**

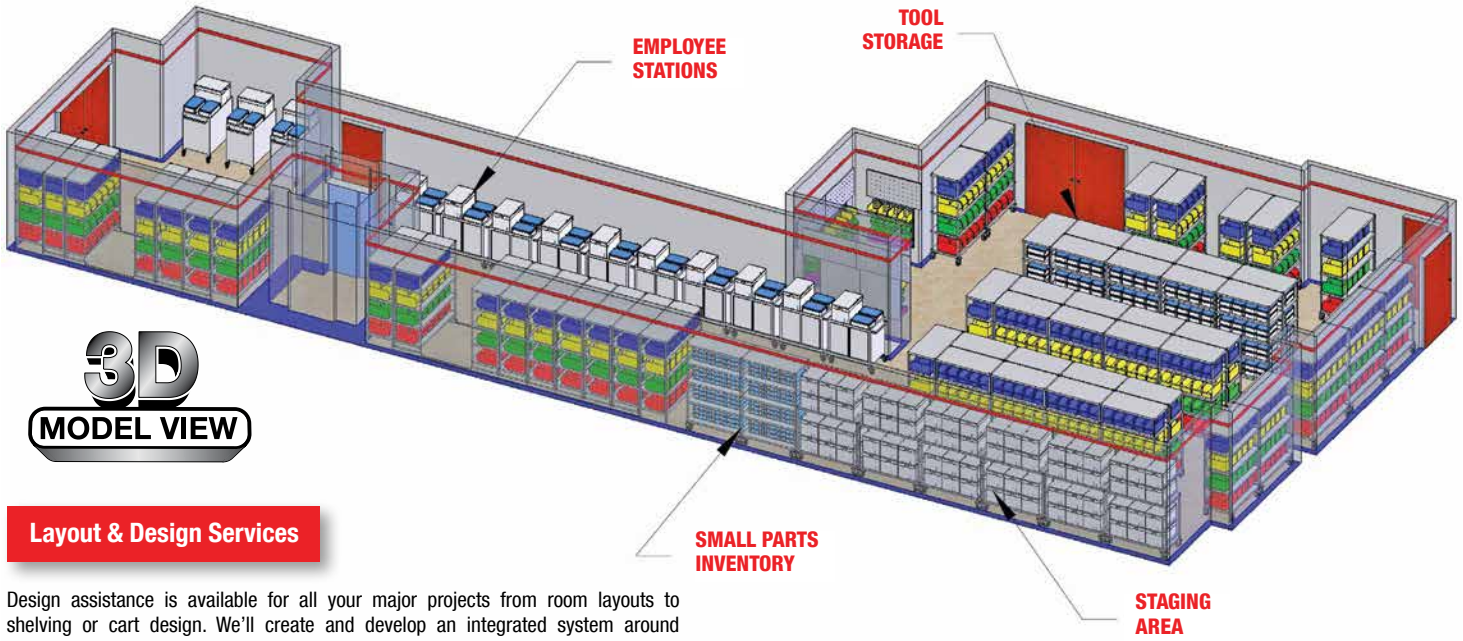

**3D MODEL VIEW**

**Layout & Design Services**

Design assistance is available for all your major projects from room layouts to shelving or cart design. We'll create and develop an integrated system around your requirements. Layouts can be created to accommodate your space with the appropriate product mix consisting of:

- Wire Shelving
- Stationary Shelving
- Bins
- Wall Systems
- Baskets
- Containers
- Hi-Density Mobile Track Systems
- Overhead Track Systems

**TO ACHIEVE THE BEST RESULTS, PLEASE PROVIDE THE FOLLOWING INFORMATION:**

- Room dimensions with door locations and door clearances, column locations (L x W) and ceiling height
- For shelving units, provide the number of shelf tiers, post height and indicate stationary or mobile
- If bins are required, indicate the appropriate size and whether they are to be used on shelving or wall mounted louvered panels

Quantum Storage offers the most complete package of storage products to satisfy all your requirements. Let us review your next project to maximize your storage space.

- Industry Exclusive 3D Modeling
- Revit Blueprint and AutoCAD Compatible
- Space Utilization and Maximization
- Plan-o-grams



**2D PLAN VIEW**

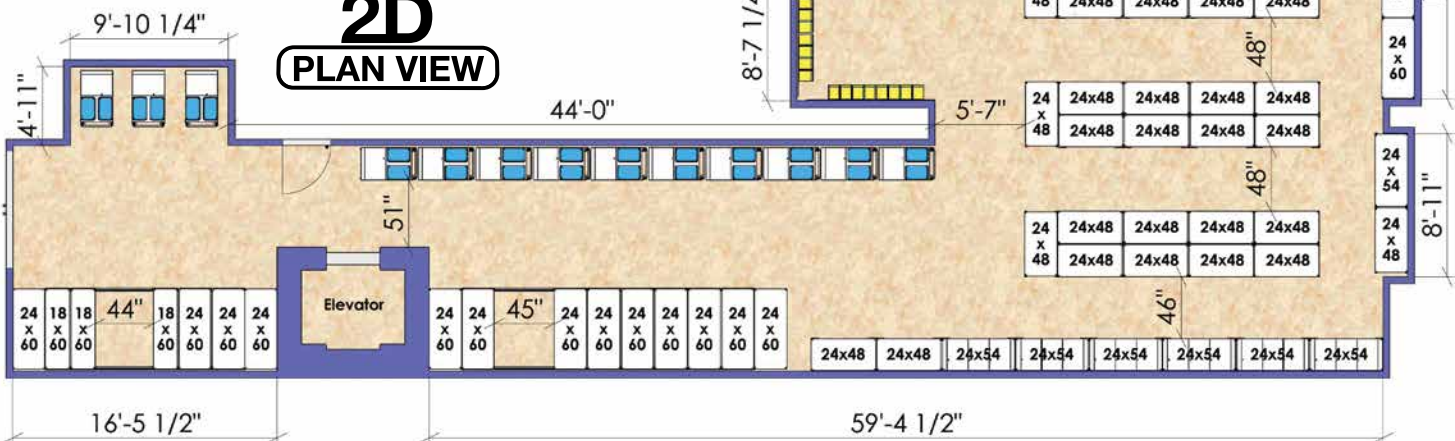

















**DESIGN ASSISTANCE AVAILABLE**









## COLOR/FINISHES OPTION ORDERING INSTRUCTIONS

In order to properly process your order, please include a color/finish code suffix to any model number available with color/finish options. Use abbreviations listed below and add them to the end of the model number without any spaces or dashes. (i.e. **QSB101** in Blue would be submitted as **QSB101BL**).

### BIN COLORS:

-  **BK** Black
-  **BL** Blue
-  **BN** Brown
-  **BR** Recycled
-  **CC** Crystal Clear
-  **CL** Clear
-  **CM** Custom
-  **CO** Conductive
-  **GN** Green
-  **GY** Gray
-  **IV** Ivory
-  **OR** Orange
-  **PU** Purple
-  **RD** Red
-  **SN** Stone
-  **WT** White
-  **YL** Yellow

### WIRE FINISHES:

-  **C** Chrome\*
-  **P** Green
-  **GY** Gray
-  **BK** Black
-  **WPM** Green/  
Plastic Green
-  **SG** Galvanized
-  **S** Stainless
-  **SS** Solid Stainless\*

\*Some products do not require suffix to be included

**KCL** efficient for CAD and Revit files



**DESIGN**  
SERVICE

**NEW**



**CONTACT US FOR MORE DETAIL**

## ICON DESCRIPTIONS



NSF  
Approved



Dishwasher  
Safe



CA Prop 65  
Approved



HACCP  
Approved



Ships All in  
One Box



Made in the  
United States  
of America



HBL165C - HBL465C	141, 145	MWR7-1711-8	71	QFS224-24 - QFS224-24+QFS400	94, 95	QP184250SS-4 - QP184250SS-5	172	QP214286SS-4 - QP214286SS-5	172
HBL3C	6, 141, 145	MWRS-5-92035 - MWRS-5-92080	134	QFS248-76 - QFS248-76+QFS400	94, 95	QP184250V5-4 - QP184250V5-5	171	QP214286V3S1 - QP214286V4S1	173
HD18 - HD36	130	MWRS-7-103 - MWRS-7-110	134	QFS270-72 - QFS270-72+QFS400	94, 95	QP184262SS-4 - QP184262SS-5	172	QP214286V5S1 - QP214286V5S-5	171
HD18-2 - HD36-3	131	MWRS-7-602 - MWRS-7-606	134	QFS400	95, 99	QP184262V3S1 - QP184262V4S1	173	QP214286SS - QP214286SS-5	170
HD18-2 - HD36-3DR	131	<b>N</b>		QFSD-2236 - QFSD-2260	183	QP184262V5-4 - QP184262V5-5	171	QP214850SS-4 - QP214850SS-5	172
HMB510C - HMB8565C	6	<b>NPB1076</b>	80	QGH600	25, 44	QP184274SS-4 - QP184274SS-5	172	QP214850V5-4 - QP214850V5-5	171
HMS006 - HNS230	11	<b>O</b>		QGH700	25, 44	QP184274V3S1 - QP184274V4S1	173	QP214862SS-4 - QP214862SS-5	172
<b>I</b>		ORG80032 - ORG81832	83	QGH700BR	85	QP184274V5-4 - QP184274V5-5	172	QP214862V3S1 - QP214862V4S1	173
<b>DR201 - IDR204</b>	98	<b>P</b>		QGH705MOB	25, 44	QP184286SS-4 - QP184286SS-5	172	QP214862V5S1 - QP214862V5S-5	171
<b>K</b>		P14BK - P96BK	105	QGH800	25, 44	QP184286V3S1 - QP184286V4S1	173	QP214874SS-4 - QP214874SS-5	172
<b>KBI-HB1757-10 - KBI-HB35007-10</b>	145	P14C	105, 111	QGH805MOB	25, 44	QP184286V5-4 - QP184286V5-5	171	QP214874V3S1 - QP214874V4S1	173
<b>KEYBD</b>	164	P14G	105	QIC-12123	98	QP1842SS - QP1842V5	170	QP214874V5-4 - QP214874V5-5	171
<b>L</b>		P14P	105, 116	QIC-122	98	QP184850SS-4 - QP184850SS-5	172	QP214886SS-4 - QP214886SS-5	172
<b>LBL2X8 - LBL5X8</b>	69	P14S	105, 111	QIC-124-122	99	QP184850V5-4 - QP184850V5-5	171	QP214886V3S1 - QP214886V4S1	173
<b>LBL2X8CO - LBL5X8CO</b>	88	P34C	105, 111	QIC-124-161	99	QP184862SS-4 - QP184862SS-5	172	QP214886V5-4 - QP214886V5-5	171
<b>LC191507</b>	68	P34GY	105	QIC-124-64	99	QP184862V3S1 - QP184862V4S1	173	QP21488SS - QP21488V5	170
<b>LD965 - LD1887</b>	65	P34P	105, 116	QIC-124-83	99	QP184862V5-4 - QP184862V5-5	172	QP215450SS-4 - QP215450SS-5	172
<b>LD5B118 - LD5B122</b>	50	P34S	105, 111	QIC-148-122	99	QP184874SS-4 - QP184874SS-5	172	QP215450V5-4 - QP215450V5-5	171
<b>LD5B218 - LD5B222</b>	55	P36C	105	QIC-148-161	99	QP184874V3S1 - QP184874V4S1	173	QP215462SS-4 - QP215462SS-5	172
<b>LH3B - LH69C</b>	141	P39C	105, 111	QIC-148-64	99	QP184874V5-4 - QP184874V5-5	171	QP215462V3S1 - QP215462V4S1	173
<b>LHA3C - LHA24C</b>	141	P42S	105, 111	QIC-148-83	99	QP184886SS-4 - QP184886SS-5	172	QP215462V5-4 - QP215462V5-5	171
<b>LHE3X5C</b>	141	P54C	105, 111	QIC-161	98	QP184886V3S1 - QP184886V4S1	173	QP215474SS-4 - QP215474SS-5	172
<b>LHI-3 - LHI-6</b>	141	P54GY	105	QIC-170-122	99	QP184886V5-4 - QP184886V5-5	171	QP215474V3S1 - QP215474V4S1	173
<b>LD1215</b>	74	P54P	105, 116	QIC-170-161	99	QP1848SS - QP1848V5	170	QP215474V5-4 - QP215474V5-5	171
<b>LD1711</b>	72	P54S	105, 111	QIC-170-64	99	QP185450SS-4 - QP185450SS-5	172	QP215486SS-4 - QP215486SS-5	172
<b>LD181 - LD1301</b>	32, 70	P63C	105, 111	QIC-170-83	99	QP185450V5-4 - QP185450V5-5	171	QP215486V3S1 - QP215486V4S1	173
<b>LD1915</b>	68	P63GY	105	QIC-224-122	99	QP185462SS-4 - QP185462SS-5	172	QP215486V5-4 - QP215486V5-5	171
<b>LD2415</b>	74	P63P	105, 116	QIC-224-161	99	QP185462V3S1 - QP185462V4S1	173	QP2154SS - QP2154V5	170
<b>LD2417</b>	72	P63S	105, 111	QIC-224-64	99	QP185462V5-4 - QP185462V5-5	171	QP216050SS-4 - QP216050SS-5	172
<b>LD2516-8</b>	72	P6C	105, 111	QIC-224-83	99	QP185474SS-4 - QP185474SS-5	172	QP216050V5-4 - QP216050V5-5	171
<b>LD-4845</b>	76	P6GY	105	QIC-248-122	99	QP185474V3S1 - QP185474V4S1	173	QP216062SS-4 - QP216062SS-5	172
<b>LTR-0813</b>	50, 55, 81	P6P	105, 116	QIC-248-161	99	QP185474V5-4 - QP185474V5-5	171	QP216062V3S1 - QP216062V4S1	173
<b>LTR-1253</b>	5, 30, 81	P6S	105, 111	QIC-248-64	99	QP185486SS-4 - QP185486SS-5	172	QP216062V5-4 - QP216062V5-5	171
<b>LTR-1300</b>	5, 21, 81	P74C - P74CX	105, 111	QIC-248-83	99	QP185486V3S1 - QP185486V4S1	173	QP216074SS-4 - QP216074SS-5	172
<b>LTR-1754</b>	5, 47, 81	P74GY - P74GX	105	QIC-270-122	99	QP185486V5-4 - QP185486V5-5	171	QP216074V3S1 - QP216074V4S1	173
<b>LTR-2400</b>	5, 34, 81	P74P - P74PX	105, 116	QIC-270-161	99	QP1854SS - QP1854V5	170	QP216074V5-4 - QP216074V5-5	171
<b>LTR-700</b>	44, 81	P74S	105, 111	QIC-270-64	99	QP186050SS-4 - QP186050SS-5	172	QP216086SS-4 - QP216086SS-5	172
<b>M</b>		P86C - P86CX	105, 111	QIC-270-83	99	QP186050V5-4 - QP186050V5-5	171	QP216086V3S1 - QP216086V4S1	173
<b>M1436-69BWSEC - M1448-69BWSEC</b>	185	P86GY	105	QIC-4163	98	QP186062SS-4 - QP186062SS-5	172	QP216086V5-4 - QP216086V5-5	171
<b>M1436-69MIXSEC - M1448-69MIXSEC</b>	185	P86P - P86PX	105, 116	QIC-4244	98	QP186062V3S1 - QP186062V4S1	173	QP2160SS - QP2160V5	170
<b>M18246DGY - M1860DGY</b>	158	P86S	105, 111	QIC-64	98	QP186062V5-4 - QP186062V5-5	171	QP217250SS-4 - QP217250SS-5	172
<b>M1836-69SEC - M1836-69SEC-2</b>	129	P96C	105, 111	QIC-81-83	98	QP186074SS-4 - QP186074SS-5	172	QP217250V5-4 - QP217250V5-5	171
<b>M1836-69SECP - M1836-69SECP-2</b>	129	P96GY	105	QIC-8224	98	QP186074V3S1 - QP186074V4S1	173	QP217262SS-4 - QP217262SS-5	172
<b>M1836BC6C - M1848BC6C</b>	139	P96P	105, 116	QIC-83	98	QP186074V5-4 - QP186074V5-5	171	QP217262V3S1 - QP217262V4S1	173
<b>M1836BK46 - M1860BK46-5</b>	125	P96S	105, 111	QLP-1819 - QLP-4861	7	QP186086SS-4 - QP186086SS-5	172	QP217262V5S1 - QP217262V5S-5	171
<b>M1836BK47 - M1860BK47-5</b>	125	PC3518-33 - PC3518-33-3	79	QLP-1819-210-16 - QLP-1819-230-9	12, 23	QP186086V3S1 - QP186086V4S1	173	QP217274SS-4 - QP217274SS-5	172
<b>M1836C46 - M1860C46-5</b>	125	PC3518SHELF	79	QLP-1861HC - QLP-4861HC	8, 14, 145	QP186086V5-4 - QP186086V5-5	171	QP217274V3S1 - QP217274V4S1	173
<b>M1836C46RE - M1860C46RE-5</b>	126	PC4026-33-2 - PC4026-33-3	79	QLP-3619-210-32 - QLP-3619-230-18	12, 23	QP1860SS - QP1860V5	170	QP217274V5-4 - QP217274V5-5	171
<b>M1836C47 - M1860C47-5</b>	125	PC4026SHELF	79	QLP-3661-220-120 - QLP-3661-240-28	12, 23	QP1867	65	QP217286SS-4 - QP217286SS-5	172
<b>M1836C47RE - M1860C47RE-5</b>	126	PC-CAS-RG	79	QLP-4861-220-165 - QLP-4861-240-35	12, 23	QP187250SS-4 - QP187250SS-5	172	QP217286V3S1 - QP217286V4S1	173
<b>M1836CG46 - M1860CG46-5</b>	125	PC-CAS-SW	79	QLR500	91	QP187250V5-4 - QP187250V5-5	170	QP217286V5-4 - QP217286V5-5	171
<b>M1836CG46RE - M1860CG46RE-5</b>	127	PCL1 - PCL2	165	QMB510C - QMB570C	6	QP187262SS-4 - QP187262SS-5	172	QP2172SS - QP2172V5	170
<b>M1836CG47 - M1860CG47-5</b>	125	PCH	79	QMD-36H	10	QP187262V3S1 - QP187262V4S1	173	QP242450SS-4 - QP242450SS-5	172
<b>M1836CG47RE - M1860CG47RE-5</b>	126	PDC-12BK - PDC-930BK	82	QMD-36H-220 - QMD-36H-240	12, 23	QP187262V5-4 - QP187262V5-5	171	QP242450V5-4 - QP242450V5-5	171
<b>M1836GY46 - M1860GY46-5</b>	125	PFT4026-33-2 - PFT4026-33-3	79	QMS531	85	QP187274SS-4 - QP187274SS-5	172	QP242462SS-4 - QP242462SS-5	172
<b>M1836GY47 - M1860GY47-5</b>	125	PH18 - PH36S	165	QMS531BR	85	QP187274V3S1 - QP187274V4S1	173	QP242462V3S1 - QP242462V4S1	173
<b>M1836P46 - M1860P46-5</b>	125	PLH1X6C - PLH2X4C	105, 111	QMS532	85	QP187274V5-4 - QP187274V5-5	172	QP242462V5S1 - QP242462V5S-5	171
<b>M1836P47 - M1860P47-5</b>	125	PS-A2475-7S	146	QMS533BR	85	QP187286SS-4 - QP187286SS-5	172	QP242474SS-4 - QP242474SS-5	172
<b>M1836SG46 - M1860SG46-5</b>	125	PS-A2475-8WB	146	QMS538	85	QP187286V3S1 - QP187286V4S1	173	QP242474V3S1 - QP242474V4S1	173
<b>M1836SG47 - M1860SG47-5</b>	125	PSC-5S	167	QMS533BR	85	QP187286V5-4 - QP187286V5-5	171	QP242474V5-4 - QP242474V5-5	171
<b>M1836SL6C - M1836SL34C</b>	134	PS-DBC-14S	147	QMS543	87	QP1872SS - QP1872V5	170	QP242486SS-4 - QP242486SS-5	172
<b>M1836SS46 - M1860SS46-5</b>	125	PS-DBC-14WB	147	QMS543BR	85	QP1887	65	QP242486V3S1 - QP242486V4S1	173
<b>M1836SS47 - M1860SS47-5</b>	125	PS-DBC-7WB7S	147	QMS743	87	QP1872SS - QP1872V5	170	QP242486V5-4 - QP242486V5-5	171
<b>M1848SL6C - M1848SL34C</b>	134	PS-DC2214	147	QMS743BR	85	QP212450SS-4 - QP212450SS-5	172	QP242486V5S1 - QP242486V5S-5	171
<b>M2036BD - M2048BD</b>	138	PS-LH3	6, 141, 147	QMS743MOB	47	QP212450V5-4 - QP212450V5-5	170	QP2424SS - QP2424V5	170
<b>M2436DGY - M2460DGY</b>	158	PS-S2475-7S	146	QMS843MOB	47	QP212462SS-4 - QP212462SS-5	172	QP243050SS-4 - QP243050SS-5	172
<b>M2430CLAN</b>	90	PS-S2475-8WB	146	QPI265	65	QP212462V3S1 - QP212462V4S1	173	QP243050V5-4 - QP243050V5-5	171
<b>M2436BC6C - M2448BC6C</b>	139	PS-SE - PS-SSE	146	QPI285	65	QP212462V5-4 - QP212462V5-5	172	QP243062SS-4 - QP243062SS-5	172
<b>M2436BK46 - M2460BK46-5</b>	125	PS-TS22184C	147	QPI496	65	QP212474SS-4 - QP212474SS-5	170	QP243062V3S1 - QP243062V4S1	173
<b>M2436BK47 - M2460BK47-5</b>	125	PS-WB-22143 - PS-WB22148	147	QP182450SS-4 - QP182450SS-5	172	QP212474V3S1 - QP212474V4S1	173	QP243062V5S1 - QP243062V5S-5	171
<b>M2436C46 - M2460C46-5</b>	125	PS-WBLD-3 - PS-WBLD-8	147	QP182450V5-4 - QP182450V5-5	171	QP212474V5-4 - QP212474V5-5	171	QP243074SS-4 - QP243074SS-5	172
<b>M2436C46RE - M2460C46RE-5</b>	126	PS-WB5D-3 - PS-WB5D-8	147	QP182462SS-4 - QP182462SS-5	172	QP212486SS-4 - QP212486SS-5	172	QP243074V3S1 - QP243074V4S1	173
<b>M2436C46RE - M2460C46RE-5</b>	126	PS-WB5D-3 - PS-WB5D-8	147	QP182462V3S1 - QP182462V4S1	173	QP212486V3S1 - QP212486V4S1	173	QP243074V5-4 - QP243074V5-5	171
<b>M2436C47 - M2460C47-5</b>	125	PS-W52414	147	QP182462V5-4 - QP182462V5-5	171	QP212486V5-4 - QP212486V5-5	171	QP243086SS-4 - QP243086SS-5	172
<b>M2436C47RE - M2460C47RE-5</b>	126	PT-NR	167	QP182474SS-4 - QP182474SS-5	172	QP2124SS - QP2124V5	170	QP243086V3S1 - QP243086V4S1	173
<b>M2436CG46 - M2460CG46-5</b>	125	PT-NS	167	QP182474V3S1 - QP182474V4S1	173	QP21305			

QP244862SS-4 - QP244862V5S-5 ..... 172
QP244862V3S1 - QP244862V4S1 ..... 173
QP244862V5S-4 - QP244862V5S-5 ..... 171
QP244874SS-4 - QP244874SS-5 ..... 172
QP244874V3S1 - QP244874V4S1 ..... 173
QP244874V5S-4 - QP244874V5S-5 ..... 171
QP244886SS-4 - QP244886V5S-5 ..... 172
QP244886V3S1 - QP244886V4S1 ..... 173
QP244886V5S-4 - QP244886V5S-5 ..... 171
QP2448SS - QP2448V5S ..... 170
QP245450SS-4 - QP245450SS-5 ..... 172
QP245450V5S-4 - QP245450V5S-5 ..... 171
QP245462SS-4 - QP245462V5S-5 ..... 172
QP245462V3S1 - QP245462V4S1 ..... 173
QP245462V5S-4 - QP245462V5S-5 ..... 171
QP245474SS-4 - QP245474SS-5 ..... 172
QP245474V3S1 - QP245474V4S1 ..... 173
QP245474V5S-4 - QP245474V5S-5 ..... 171
QP245486SS-4 - QP245486V5S-5 ..... 172
QP245486V3S1 - QP245486V4S1 ..... 173
QP245486V5S-4 - QP245486V5S-5 ..... 171
QP2454F ..... 176
QP2454SS - QP2454V5S ..... 170
QP246050SS-4 - QP246050SS-5 ..... 172
QP246050V5S-4 - QP246050V5S-5 ..... 171
QP246062SS-4 - QP246062V5S-5 ..... 172
QP246062V3S1 - QP246062V4S1 ..... 173
QP246062V5S-4 - QP246062V5S-5 ..... 171
QP246074SS-4 - QP246074SS-5 ..... 172
QP246074V3S1 - QP246074V4S1 ..... 173
QP246074V5S-4 - QP246074V5S-5 ..... 171
QP246086SS-4 - QP246086V5S-5 ..... 172
QP246086V3S1 - QP246086V4S1 ..... 173
QP246086V5S-4 - QP246086V5S-5 ..... 171
QP2460SS - QP2460V5S ..... 170
QP247250SS-4 - QP247250SS-5 ..... 172
QP247250V5S-4 - QP247250V5S-5 ..... 171
QP247262SS-4 - QP247262V5S-5 ..... 172
QP247262V3S1 - QP247262V4S1 ..... 173
QP247262V5S-4 - QP247262V5S-5 ..... 171
QP247274SS-4 - QP247274SS-5 ..... 172
QP247274V3S1 - QP247274V4S1 ..... 173
QP247274V5S-4 - QP247274V5S-5 ..... 171
QP247286SS-4 - QP247286V5S-5 ..... 172
QP247286V3S1 - QP247286V4S1 ..... 173
QP247286V5S-4 - QP247286V5S-5 ..... 171
QP2472SS - QP2472V5S ..... 170
QP965 ..... 65
QP-ADC ..... 174
QPDI18 - QPDI24 ..... 174
QPDR1 - QPDR2 ..... 176
QPD5 ..... 176
QPPA ..... 170
QPG ..... 170, 175
QPL18 - QPL72 ..... 174
QPLH5C - QPLH65C ..... 174
QPLH1-3 - QPLH1-5 ..... 174
QPM243068DR - QPM243068WDR ..... 176
QPM243068PDR1 - QPM245468PDR1 ..... 176
QPM243068PDR2 - QPM245468PDR2 ..... 176
QPM244268DR - QPM244268WDR ..... 176
QPM245468DR - QPM245468WDR ..... 176
QPP14 - QPP98 ..... 170
QPPC ..... 170
QPPSC-55 ..... 171-174
QPR-101 - QPR-107 ..... 17
QPRD-000 ..... 52, 64
QPRD-100 - QPRD-109 ..... 26, 52
QPRD-201 - QPRD-209 ..... 29, 57
QPRD-501 - QPRD-5678 ..... 64
QPRD-6 ..... 57
QPRHA-000 ..... 52, 64
QPRHA-100 - QPRHA-109 ..... 26, 52
QPRHA-201 - QPRHA-209 ..... 29, 57
QPRHA-501 - QPRHA-701 ..... 64
QPRHA-6 ..... 57
QPRS-000 ..... 52, 64
QPRS-100 - QPRS-109 ..... 26, 52
QPRS-201 - QPRS-209 ..... 29, 57
QPRS-501 - QPRS-5678 ..... 64
QP-S-HOOK - QP-S-HOOKL ..... 174
QPS ..... 170
QPWDR ..... 176
QP-WMB ..... 175
QRB166 ..... 42
QRB176MOB ..... 42
QRB206 ..... 42
QRB216MOB ..... 42
QRB246 ..... 42
QRB256MOB ..... 42
QRC-4D ..... 19
QRU-12D - QRU-12S ..... 11
QRU-12D-220-192 - QRU-12D-240-48, 12, 23
QRU-12S-220-96 - QRU-12S-240-24 ..... 12, 23
QRU-16D - QRU-16S ..... 11
QRU-16D-230-96 ..... 12, 23
QRU-16S-220230240 - QRU-16S-230-48, 12, 23
QRU-1W - QRU-1WHC ..... 11
QRU-MOB ..... 11, 12, 23
QS-000 ..... 96
QS-304-28 ..... 96
QS-305306-52 ..... 96
QS-305-36 ..... 96
QS-306-56 ..... 96
QS-309-80 ..... 96
QS-569-56 ..... 96

QS-725 ..... 97
QSB100 ..... 26, 50
QSB100BR ..... 85
QSB100CO ..... 87
QSB101 ..... 26, 50
QSB101BR ..... 85
QSB101CO ..... 87
QSB102 ..... 26, 50
QSB102BR ..... 85
QSB102CO ..... 87
QSB103 ..... 26, 50
QSB103BR ..... 85
QSB103CO ..... 87
QSB104 ..... 26, 50
QSB104BR ..... 85
QSB104CO ..... 87
QSB105 ..... 26, 50
QSB105BR ..... 85
QSB105CO ..... 87
QSB106 ..... 26, 50
QSB106BR ..... 85
QSB106CO ..... 87
QSB107 ..... 26, 50
QSB107BR ..... 85
QSB107CO ..... 87
QSB108 ..... 26, 50
QSB108BR ..... 85
QSB108CO ..... 87
QSB109 ..... 26, 50
QSB109BR ..... 85
QSB109CO ..... 87
QSB110 ..... 26, 50
QSB110BR ..... 85
QSB110CO ..... 87
QSB114 ..... 26, 50
QSB114BR ..... 85
QSB114CO ..... 87
QSB116 ..... 26, 50
QSB116BR ..... 85
QSB116CO ..... 87
QSB118 ..... 26, 50
QSB118BR ..... 85
QSB122 ..... 26, 50
QSB122BR ..... 85
QSB201 ..... 28, 55
QSB202 ..... 28, 55
QSB203 ..... 28, 55
QSB204 ..... 28, 55
QSB205 ..... 28, 55
QSB206 ..... 28, 55
QSB207 ..... 28, 55
QSB208 ..... 28, 55
QSB209 ..... 28, 55
QSB210 ..... 28, 55
QSB214 ..... 28, 55
QSB216 ..... 28, 55
QSB218 ..... 28, 55
QSB222 ..... 28, 55
QSB801 ..... 30, 59
QSB802 ..... 30, 59
QSB803 ..... 30, 59
QSB804 ..... 30, 59
QSB805 ..... 30, 59
QSB806 ..... 30, 59
QSB807 ..... 30, 59
QSB808 ..... 30, 59
QSB809 ..... 30, 59
QSB810 ..... 30, 59
QSB814 ..... 30, 59
QSB816 ..... 30, 59
QS-BIG-101 ..... 96
QSBU-230240 ..... 14, 22
QSBU-239 ..... 14, 22
QSBU-240 ..... 14, 22
QSBU-250 ..... 14, 22
QSBU-255 ..... 14, 22
QSBU-260 ..... 14, 22
QSBU-265 ..... 14, 22
QSBU-275 ..... 14, 22
QSBU-600 ..... 25, 45
QSBU-600800 ..... 25, 45
QSBU-700 ..... 25, 45
QSBU-800 ..... 25, 45
QSC-32-2S-6DS ..... 16
QSC-36 ..... 16
QSC-36-32-4IS ..... 16
QSC-36-4IS-12DS ..... 16
QSC-36-68 ..... 16
QSC-3672-4D ..... 17
QSC-36-96-4IS ..... 16
QSC-36-FD ..... 16
QSC-36-MIN ..... 17
QSC-36S ..... 16
QSC-36S-38 ..... 16
QSC-3IS ..... 19
QSC-4S ..... 18
QSC-4803 ..... 18
QSC-4804 ..... 18
QSC-4805 ..... 18
QSC-48S ..... 18
QSC-4IS-14DS ..... 18
QSC-60 - QSC-60S ..... 20
QSC-64-2S-6DS ..... 16
QSC-72 - QSC-72S-84 ..... 20
QSC-C240 - QSC-240250 ..... 17
QSC-01C161 - QSC-01C64 ..... 17

QSC-0TB36-35 - QSC-0TB79-61 ..... 19
QSMC ..... 112-115
QSSR ..... 126
QSS-1866H ..... 10
QSS-3666H ..... 10
QTB301 ..... 91
QTB302 ..... 91
QTB303 ..... 91
QTB304 ..... 91
QTB305 ..... 91
QTB306 ..... 91
QTB309 ..... 91
QTB405 ..... 92
QTB406 ..... 92
QTB409 ..... 92
QTB410 ..... 92
QTB669 ..... 92
QTB-LP-BKT ..... 91
QTF24 - QTF70 ..... 93
QTR24 - QTR70 ..... 93
QUS210 ..... 5, 22
QUS210BR ..... 85
QUS210CC ..... 5, 21
QUS210CO ..... 86
QUS220 ..... 5, 79
QUS220BR ..... 85
QUS220CC ..... 5, 21
QUS220CO ..... 86
QUS221 ..... 5, 22
QUS221BR ..... 85
QUS224 ..... 5, 22
QUS224BR ..... 85
QUS230 ..... 5, 22
QUS230BR ..... 85
QUS230CC ..... 5, 21
QUS230CO ..... 86
QUS232 ..... 5, 22
QUS232BR ..... 85
QUS234 ..... 5, 22
QUS234BR ..... 85
QUS235 ..... 5, 22
QUS235BR ..... 85
QUS235CO ..... 86
QUS236 ..... 5, 22
QUS236BR ..... 85
QUS238 ..... 5, 22
QUS238BR ..... 85
QUS239 ..... 5, 22
QUS239BR ..... 85
QUS239CO ..... 86
QUS240 ..... 5, 22
QUS240BR ..... 85
QUS240CC ..... 5, 21
QUS240CO ..... 86
QUS241 ..... 5, 22
QUS241BR ..... 85
QUS242 ..... 5, 22
QUS242BR ..... 85
QUS245 ..... 5, 22
QUS245BR ..... 85
QUS248BR ..... 85
QUS250 ..... 5, 22
QUS250BR ..... 85
QUS250CO ..... 86
QUS255 ..... 5, 24
QUS255BR ..... 85
QUS255CO ..... 86
QUS260 ..... 5, 22
QUS260BR ..... 85
QUS260CO ..... 86
QUS265 ..... 5, 22
QUS265BR ..... 85
QUS270 ..... 5, 22
QUS270BR ..... 85
QUS270CO ..... 86
QUS275MOB ..... 5, 22
QUS275MOBR ..... 85
QUS950 ..... 24, 36
QUS951 ..... 24, 36
QUS952 ..... 24, 36
QUS953 ..... 24, 36
QUS954 ..... 24, 36
QUS955 ..... 24, 36
QUS957 ..... 24, 36
QUS957MOB ..... 24, 36
QUS964MOB ..... 24, 36
QUS965MOB ..... 24, 36
QUS967MOB ..... 24, 36
QUS970 ..... 39
QUS973 ..... 39
QUS974 ..... 39
QUS975 ..... 39
QUS976 ..... 39
QUS984MOB ..... 39
QUS985MOB ..... 39
QUS986MOB ..... 39
QUS993 ..... 39

QUS994MOB ..... 39
QUS995 ..... 39
QUS996MOB ..... 39
QUS997 ..... 39
QUS998MOB ..... 39
QVTRK ..... 130
QVTRK-2-72EST - QVTRK-2-240EST ..... 131
QVTRK-3-72EST - QVTRK-3-240EST ..... 131
R
RLH1X3C ..... 81
RS01207-5 ..... 74
RS01215-5 ..... 74
RS01215-7 ..... 74
RS02415-5 ..... 74
RS02415-7 ..... 74
RS02415-9 ..... 74
RS02422-11 ..... 74
RWR72-1830LD - RWR72-2448LD ..... 118
RWR72-1830LDBK - RWR72-2448LDBK ..... 118
RWR72-1830LDP - RWR72-2448LDP ..... 118
S
SCH1 ..... 156, 166
SCH1-5 ..... 166
SD36-18C - SD60-24P ..... 129
SG-1830GY SG-1860P ..... 149
SG-2430GY - SG-2448P ..... 149
SG-3036GY - SG-3048P ..... 149
SG-3354GY - SG-3354P ..... 149
SG-A1 - SG-A2 ..... 153
SG-B1357GY - SG-B1357P ..... 154
SG-B17710GY - SG-B17710P ..... 154
SG-B1775GY - SG-B1775P ..... 154
SG-BH29GY - SG-BH29P ..... 154
SG-BR6GY - SG-BR6P ..... 154
SG-CD14GY - SG-CD24P ..... 149
SG-CH ..... 154
SG-CMBGY - SG-CMBP ..... 154
SG-CS14GY - SG-CS24P ..... 149
SG-DWB ..... 149
SG-GBHGY - SG-GBHP ..... 154
SG-HA5P ..... 154
SG-HFF ..... 154
SG-HOLDERGY - SG-HOLDERP ..... 154
SG-HOOK6GY - SG-HOOK6P ..... 154
SG-HOOKDB - SG-HOOKDBGY ..... 154
SG-HOOKLG - SG-HOOKLGGY ..... 154
SG-HOOKSM - SG-HOOKSMGY ..... 154
SG-IPH ..... 154
SGK-2448-1GY - SGK-2448-1P ..... 150
SGK-3036-1GY - SGK-3036-1P ..... 150
SGK-401836-1GY - SGK-401836-1P ..... 150
SGK-401836-2GY - SGK-401836-2P ..... 151
SGK-401836-3GY - SGK-401836-3P ..... 151
SGK-401836-4GY - SGK-401836-4P ..... 151
SGK-402436-1P ..... 151
SGK-403036-1GY - SGK-403036-1P ..... 151
SGK-403036-2GY - SGK-403036-2P ..... 152
SGK-403036-3GY - SGK-403036-3P ..... 152
SGK-562448-1GY - SGK-562448-1P ..... 152
SGK-563048-1GY - SGK-563048-1P ..... 152
SGK-721830-1GY - SGK-721830-1P ..... 153
SGK-723036-1GY - SGK-723036-1P ..... 153
SGK-803036-1GY - SGK-803036-1P ..... 153
SGK-961830-1GY - SGK-961830-1P ..... 153
SG-LGBH ..... 154
SG-LH1384GY - SG-LH1384P ..... 154
SG-LS1436GY - SG-LS1436P ..... 154
SG-LS1448GY - SG-LS1448P ..... 154
SG-LS1830GY - SG-LS1830P ..... 154
SG-LS1836GY - SG-LS1836P ..... 154
SG-LS1848GY - SG-LS1848P ..... 154
SG-PWM ..... 149
SG-S1224GY - SG-S1224P ..... 154
SG-S1616GY - SG-S1616P ..... 154
SG-S918GY - SG-S918P ..... 154
SG-SBH ..... 154
SG-SLH201412GY - SG-SLH201412P ..... 154
SG-SMBH ..... 154
SG-SR2254GY - SG-SR2254P ..... 154
SG-TDR341410GY - SG-TDR341410P ..... 154
SG-TDR461410GY - SG-TDR461410P ..... 154
SG-U16GY - SG-U44P ..... 149
SG-UH10GY - SG-UH10P ..... 154
SG-UH4GY - SG-UH4P ..... 154
SG-WT40GY - SG-WT72P ..... 149
SG-WTBGY - SG-WTBS ..... 149
S-HOOK ..... 166
S-HOOKBK ..... 166
S-HOOKGY ..... 166
S-HOOKP ..... 166
S-HOOKSS ..... 166
S-HOOKWPM ..... 116, 189
SK ..... 130
SL12 - SL30 ..... 165
SL12BK - SL30BK ..... 165
SL12GY - SL30GY ..... 165
SL12P - SL30P ..... 165
SL12S - SL30S ..... 165
SLP-1236 - SLP-1836 ..... 9
SLP-A1236 - SLP-A1836 ..... 9
SMH010 ..... 70, 72, 81
SMT180 ..... 32, 70
SMT185 ..... 32, 70
SMT190 ..... 32, 70
SMT195 ..... 32, 70
SMT200 ..... 32, 70

SMT225 ..... 32, 70
SMT230 ..... 32, 70
SMT240 ..... 32, 70
SMT300 ..... 32, 70
SSB423 ..... 34
SSB425 ..... 34
SSB441 ..... 34
SSB443 ..... 34
SSB445 ..... 34
SSB461 ..... 34
SSB463 ..... 34
SSB465 ..... 34
SSB483 ..... 34
SSB485 ..... 34
SST-2436U - SST-2472U ..... 179
SST-MOB ..... 179
T
TB12 ..... 80
TC-19 ..... 89
TC-19CO ..... 162
TC-20 ..... 89
TC-20CO ..... 89
TC-31 ..... 162
TC-31CO ..... 89
TC-39 ..... 162
TC-39CO ..... 89
TC-500 ..... 80
TC-EL38 ..... 162
TC-EL38CO ..... 89
TDR24361GY - TDR24603GY ..... 189
TK-2 - TK-7 ..... 132
TK-CA ..... 132
TK-CBW ..... 132
TK-DTB18 - TK-DTB24 ..... 132
TK-EP ..... 132
TK-STB18 - TK-STB24 ..... 132
TR1-2516-8 - TR12-2516-8 ..... 73
TR-96 ..... 79
TS18C - TS62C ..... 162
TT-CT9 - TT-CT15 ..... 77
TTD-30 - TTD-40 ..... 77
TT-DIV3 - TT-DIV6 ..... 77
TTD-0T15-240 ..... 133
TTK-8 - TTK21 ..... 77
TTK-C18 - TTK-C24 ..... 133
TTK-E18 - TTK-E24 ..... 133
TTK-M18 - TTK-M24 ..... 133
TT-0T9 - TT-0T15 ..... 77
TTS-18 - TTS-24 ..... 72
TUB1711-12 ..... 72
TUB1711-8 ..... 72
TUB2417-12 ..... 72
TUB2417-8 ..... 72
TUB2419-9 ..... 72
TUB2516-8 ..... 72
U
UB10 ..... 163
UH18 - UH24S ..... 165
ULH3C - ULH69C ..... 163, 189
W
W7-12-24 - W7-18-30 ..... 65
WC14-1436WBK - WC14-1448WC-2 ..... 185
WC14-CB1224BK - WC14-CB2472P ..... 157
WC34-1436WBK-2 - WC34-1448WC-6 ..... 185
WC34-CB1224BK - WC34-CB2472P ..... 157
WC54-1436WBK-4 - WC54-1448WC-8 ..... 185
WCSD-1814 - WCSD-2420 ..... 165
WDWB1224BK - WDWB1272BK ..... 156
WDWB1224GY - WDWB1272GY ..... 156
WDWB1224P - WDWB1272P ..... 156
WDWB1424BK - WDWB1472BK ..... 156
WDWB1424C - WDWB1472C ..... 156
WDWB1424GY - WDWB1472GY ..... 156
WDWB1424P - WDWB1472P ..... 156
WDWB1824BK - WDWB1872BK ..... 156
WDWB1824C - WDWB1872C ..... 156
WDWB1824GY - WDWB1872GY ..... 156
WDWB1824P - WDWB1872P ..... 156
WDWB2124BK - WDWB2172BK ..... 156
WDWB2124C - WDWB2172C ..... 156
WDWB2124GY - WDWB2172GY ..... 156
WDWB2124P - WDWB2172P ..... 156
WDWB2424BK - WDWB2472BK ..... 156
WDWB2424C - WDWB2472C ..... 156
WDWB2424GY - WDWB2472GY ..... 156
WDWB2424P - WDWB2472P ..... 156
WGH600 - WGH800 ..... 25, 44
WH-15 ..... 80
WK ..... 130
WLP-1836C - WLP-3048C ..... 7, 86
WLP-DMC ..... 7
WLP-OSC ..... 7
WMS531 - WMS543 ..... 107
W-PC ..... 145, 111
W-PC-STUD ..... 105, 111
W-PLB - W-PLBS ..... 105, 111
W-PLI ..... 105, 111
WR-00CO ..... 167
WR-00H ..... 167
WR-00H-5 ..... 120
WR-00H-HD ..... 120
WR-00HS ..... 167
WR10-230240 ..... 15, 22
WR12-101 - WR12-116 ..... 26, 53

WR12-10100 - WR12-11600.....	87	WR63-3036G - WR63-3072S-5.....	107	WR8-423 - WR8-483485.....	35	WRCP-63-2460.....	181	.....	WRSAD4-86-2172SS.....	114	
WR12-93030.....	33, 71	WR63-3636BK - WR63-3672BK-5.....	107	WR86-1236BK - WR86-1272BK-5.....	109	WRCP-63-2460-955.....	182	.....	WRSAD4-86-2436SS.....	114	
WR-3.....	167, 118	WR63-3636G - WR63-3672G-5.....	107	WR86-1236C - WR86-1272C-5.....	109	WRCP-R264C.....	90, 121	.....	WRSAD4-86-2472SS.....	114	
WR4-12225.....	32, 71	WR63-3636GY - WR63-3672GY-5.....	107	WR86-1236GY - WR86-1272GY-5.....	109	WRCP-R468C.....	121	.....	WRSAD5-54-1436SS.....	115	
WR4-39-1236-801 - WR4-39-1236-809.....	31, 61	WR63-3636P - WR63-3672P-5.....	107	WR86-1236P - WR86-1272P-5.....	109	WRCP-R60C.....	121	.....	WRSAD5-54-1824SS.....	115	
WR5-270.....	15, 22	WR63-3636S - WR63-3672S-5.....	107	WR86-1236S - WR86-1272S-5.....	109	WRCS4-63-2436EP.....	128	.....	WRSAD5-54-1824SS.....	115	
WR5-36MSBA - WR5-36MSBA-MOB.....	138	WR6-36-1236-101 - WR6-36-1236-109.....	26, 53	WR86-1424BK - WR86-1472BK-5.....	109	.....	WRCS4-63-2460EP-5.....	128	.....	WRSAD5-54-1824SS.....	115
WR5-39-1236-201 - WR5-39-1236-209.....	28, 58	WR6-36-1236-101C0.....	87	WR86-1424G - WR86-1472G-5.....	109	.....	WRCS4-74-2460EP-5.....	128	.....	WRSAD5-54-2124SS.....	115
WR54-1236BK - WR54-1272BK-5.....	106	.....	WR6-36-1236-109C0.....	87	WR86-1424P - WR86-1472P-5.....	109	.....	.....	.....	WRSAD5-54-2124SS.....	115
WR54-1236G - WR54-1272G-5.....	106	WR6-953.....	24, 38	WR86-1424WPM - WR86-2472WPM-5.....	117	.....	.....	.....	.....	WRSAD5-54-2472SS.....	115
WR54-1236P - WR54-1272P-5.....	106	WR6-954.....	24, 38	WR86-1424WPM5 - WR86-2472WPM5-5.....	117	.....	.....	.....	.....	WRSAD5-63-1436SS.....	115
WR54-1236S - WR54-1272S-5.....	106	WR6-957.....	24, 38	WR86-1430S - WR86-1472S-5.....	109	.....	.....	.....	.....	WRSAD5-63-1472SS.....	115
WR54-1242BK - WR54-1472BK-5.....	106	WR6-973.....	40	WR86-1436SG - WR86-1472SG-5.....	112	.....	.....	.....	.....	WRSAD5-63-1824SS.....	115
WR54-1424G - WR54-1472G-5.....	106	WR6-973974.....	40	WR86-1436SG-5 - WR86-1472SG-5.....	113	.....	.....	.....	.....	WRSAD5-63-1824SS.....	115
WR54-1424P - WR54-1472P-5.....	106	WR6-974.....	40	WR86-1824BK - WR86-1872BK-5.....	109	.....	.....	.....	.....	WRSAD5-63-1824SS.....	115
WR54-1430S - WR54-1472S-5.....	106	WR7-20-MIX.....	24, 38	WR86-1824C - WR86-1872C-5.....	109	.....	.....	.....	.....	WRSAD5-63-1824SS.....	115
WR54-1436SG - WR54-1472SG-5.....	112	WR74-1236BK - WR74-1272BK-5.....	108	WR86-1824GY - WR86-1872GY-5.....	109	.....	.....	.....	.....	WRSAD5-63-2124SS.....	115
WR54-1436SG-5 - WR54-1472SG-5.....	113	WR74-1236G - WR74-1272G-5.....	108	WR86-1824P - WR86-1872P-5.....	109	.....	.....	.....	.....	WRSAD5-63-2124SS.....	115
WR54-1824BK - WR54-1872BK-5.....	106	WR74-1236P - WR74-1272P-5.....	108	WR86-1824S - WR86-1872S-5.....	109	.....	.....	.....	.....	WRSAD5-74-1472SS.....	115
WR54-1824G - WR54-1872G-5.....	106	WR74-1236S - WR74-1272S-5.....	108	WR86-1836SG - WR86-1872SG-5.....	113	.....	.....	.....	.....	WRSAD5-74-1824SS.....	115
WR54-1824P - WR54-1872P-5.....	106	WR74-1248-101102.....	54	WR86-1836SG-5 - WR86-1872SG-5.....	113	.....	.....	.....	.....	WRSAD5-74-2124SS.....	115
WR54-1824S - WR54-1872S-5.....	106	WR74-1248-110101.....	54	WR86-1836SG-5 - WR86-1872SG-5.....	113	.....	.....	.....	.....	WRSAD5-74-2124SS.....	115
WR54-1836SG - WR54-1872SG.....	112	WR74-1248-66102.....	54	WR86-1836SG-5 - WR86-1872SG-5.....	113	.....	.....	.....	.....	WRSAD5-74-2472SS.....	115
WR54-1836SG-5 - WR54-1872SG-5.....	113	WR74-1260-101102.....	54	WR86-1836SG-5 - WR86-1872SG-5.....	113	.....	.....	.....	.....	WRSAD5-74-2472SS.....	115
WR54-2124BK - WR54-2172BK-5.....	106	WR74-1260-143101.....	54	WR86-1836SG-5 - WR86-1872SG-5.....	113	.....	.....	.....	.....	WRSAD5-74-2472SS.....	115
WR54-2124G - WR54-2172G-5.....	106	WR74-1260-88102.....	54	WR86-1836SG-5 - WR86-1872SG-5.....	113	.....	.....	.....	.....	WRSAD5-74-2472SS.....	115
WR54-2124P - WR54-2172P-5.....	106	WR74-1272-101102.....	54	WR86-1836SG-5 - WR86-1872SG-5.....	113	.....	.....	.....	.....	WRSAD5-74-2472SS.....	115
WR54-2124S - WR54-2172S-5.....	106	WR74-1272-176101.....	54	WR86-1836SG-5 - WR86-1872SG-5.....	113	.....	.....	.....	.....	WRSAD5-74-2472SS.....	115
WR54-2136SG - WR54-2172SG.....	112	WR74-1424BK - WR74-1472BK-5.....	108	WR86-1836SG-5 - WR86-1872SG-5.....	113	.....	.....	.....	.....	WRSAD5-74-2472SS.....	115
WR54-2136SG-5 - WR54-2172SG-5.....	113	WR74-1424C - WR74-1472C-5.....	108	WR86-1836SG-5 - WR86-1872SG-5.....	113	.....	.....	.....	.....	WRSAD5-74-2472SS.....	115
WR54-2424BK - WR54-2472BK-5.....	106	WR74-1424GY - WR74-1472GY-5.....	108	WR86-1836SG-5 - WR86-1872SG-5.....	113	.....	.....	.....	.....	WRSAD5-74-2472SS.....	115
WR54-2424G - WR54-2472G-5.....	106	WR74-1424P - WR74-1472P-5.....	108	WR86-1836SG-5 - WR86-1872SG-5.....	113	.....	.....	.....	.....	WRSAD5-74-2472SS.....	115
WR54-2424P - WR54-2472P-5.....	106	WR74-1424WPM - WR74-1472WPM-5.....	117	WR86-1836SG-5 - WR86-1872SG-5.....	113	.....	.....	.....	.....	WRSAD5-74-2472SS.....	115
WR54-2424S - WR54-2472S-5.....	106	WR74-1424WPM5 - WR74-1472WPM5-5.....	117	WR86-1836SG-5 - WR86-1872SG-5.....	113	.....	.....	.....	.....	WRSAD5-74-2472SS.....	115
WR54-2436SG - WR54-2472SG.....	112	WR74-1430S - WR74-1472S-5.....	108	WR86-1836SG-5 - WR86-1872SG-5.....	113	.....	.....	.....	.....	WRSAD5-74-2472SS.....	115
WR54-2436SG-5 - WR54-2472SG-5.....	113	WR74-1436SG - WR74-1472SG.....	112	WR86-1836SG-5 - WR86-1872SG-5.....	113	.....	.....	.....	.....	WRSAD5-74-2472SS.....	115
WR54-3036BK - WR54-3072BK-5.....	106	WR74-1436SG-5 - WR74-1472SG-5.....	113	WR86-1836SG-5 - WR86-1872SG-5.....	113	.....	.....	.....	.....	WRSAD5-74-2472SS.....	115
WR54-3036G - WR54-3072G-5.....	106	WR74-1436WSBK - WR74-1436WSC.....	184	WR86-1836SG-5 - WR86-1872SG-5.....	113	.....	.....	.....	.....	WRSAD5-74-2472SS.....	115
WR54-3036P - WR54-3072P-5.....	106	WR74-1824BK - WR74-1872BK-5.....	108	WR86-1836SG-5 - WR86-1872SG-5.....	113	.....	.....	.....	.....	WRSAD5-74-2472SS.....	115
WR54-3036S - WR54-3072S-5.....	106	WR74-1824C - WR74-1872C-5.....	108	WR86-1836SG-5 - WR86-1872SG-5.....	113	.....	.....	.....	.....	WRSAD5-74-2472SS.....	115
WR54-3636BK - WR54-3672BK-5.....	106	WR74-1824GY - WR74-1872GY-5.....	108	WR86-1836SG-5 - WR86-1872SG-5.....	113	.....	.....	.....	.....	WRSAD5-74-2472SS.....	115
WR54-3636G - WR54-3672G-5.....	106	WR74-1824P - WR74-1872P-5.....	108	WR86-1836SG-5 - WR86-1872SG-5.....	113	.....	.....	.....	.....	WRSAD5-74-2472SS.....	115
WR54-3636P - WR54-3672P-5.....	106	WR74-1824S - WR74-1872S-5.....	108	WR86-1836SG-5 - WR86-1872SG-5.....	113	.....	.....	.....	.....	WRSAD5-74-2472SS.....	115
WR54-3636S - WR54-3672S-5.....	106	WR74-1824WPM - WR74-1872WPM-5.....	117	WR86-1836SG-5 - WR86-1872SG-5.....	113	.....	.....	.....	.....	WRSAD5-74-2472SS.....	115
WR5-533.....	49	WR74-1824WPM5 - WR74-1872WPM5-5.....	117	WR86-1836SG-5 - WR86-1872SG-5.....	113	.....	.....	.....	.....	WRSAD5-74-2472SS.....	115
WR5-543.....	49	WR74-1836CRNC - WR74-1836CRNP-5.....	120	WR86-1836SG-5 - WR86-1872SG-5.....	113	.....	.....	.....	.....	WRSAD5-74-2472SS.....	115
WR5-600.....	25, 46	WR74-1836SG - WR74-1872SG.....	112	WR86-1836SG-5 - WR86-1872SG-5.....	113	.....	.....	.....	.....	WRSAD5-74-2472SS.....	115
WR5-600800.....	25, 46	WR74-1836SG-5 - WR74-1872SG-5.....	113	WR86-1836SG-5 - WR86-1872SG-5.....	113	.....	.....	.....	.....	WRSAD5-74-2472SS.....	115
WR5-700.....	25, 46	WR74-1848-103104.....	54	WR86-1836SG-5 - WR86-1872SG-5.....	113	.....	.....	.....	.....	WRSAD5-74-2472SS.....	115
WR5-800.....	25, 46	WR74-1848-110103.....	54	WR86-1836SG-5 - WR86-1872SG-5.....	113	.....	.....	.....	.....	WRSAD5-74-2472SS.....	115
WR5-955.....	24, 38	WR74-1848-66104.....	54	WR86-1836SG-5 - WR86-1872SG-5.....	113	.....	.....	.....	.....	WRSAD5-74-2472SS.....	115
WR5-975.....	24, 38	WR74-1860-103104.....	54	WR86-1836SG-5 - WR86-1872SG-5.....	113	.....	.....	.....	.....	WRSAD5-74-2472SS.....	115
WR5-993.....	41	WR74-1860-88104.....	54	WR86-1836SG-5 - WR86-1872SG-5.....	113	.....	.....	.....	.....	WRSAD5-74-2472SS.....	115
WR5-995.....	41	WR74-1872-103104.....	54	WR86-1836SG-5 - WR86-1872SG-5.....	113	.....	.....	.....	.....	WRSAD5-74-2472SS.....	115
WR5-997.....	41	WR74-1872-176103.....	54	WR86-1836SG-5 - WR86-1872SG-5.....	113	.....	.....	.....	.....	WRSAD5-74-2472SS.....	115
WR6-13-MIX.....	49	WR74-2124BK - WR74-2172BK-5.....	108	WR86-1836SG-5 - WR86-1872SG-5.....	113	.....	.....	.....	.....	WRSAD5-74-2472SS.....	115
WR6-191507.....	68	WR74-2124C - WR74-2172C-5.....	108	WR86-1836SG-5 - WR86-1872SG-5.....	113	.....	.....	.....	.....	WRSAD5-74-2472SS.....	115
WR6-24185.....	32, 71	WR74-2124GY - WR74-2172GY-5.....	108	WR86-1836SG-5 - WR86-1872SG-5.....	113	.....	.....	.....	.....	WRSAD5-74-2472SS.....	115
WR6-260.....	15, 22	WR74-2124P - WR74-2172P-5.....	108	WR86-1836SG-5 - WR86-1872SG-5.....	113	.....	.....	.....	.....	WRSAD5-74-2472SS.....	115
WR6-265.....	15, 22	WR74-2124S - WR74-2172S-5.....	108	WR86-1836SG-5 - WR86-1872SG-5.....	113	.....	.....	.....	.....	WRSAD5-74-2472SS.....	115
WR63-1236BK - WR63-1272BK-5.....	107	WR74-2124WPM - WR74-2172WPM-5.....	117	WR86-1836SG-5 - WR86-1872SG-5.....	113	.....	.....	.....	.....	WRSAD5-74-2472SS.....	115
WR63-1236G - WR63-1272G-5.....	107	WR74-2124WPM5 - WR74-2172WPM5-5.....	117	WR86-1836SG-5 - WR86-1872SG-5.....	113	.....	.....	.....	.....	WRSAD5-74-2472SS.....	115
WR63-1236P - WR63-1272P-5.....	107	WR74-2136SG - WR74-2172SG.....	112	WR86-1836SG-5 - WR86-1872SG-5.....	113	.....	.....	.....	.....	WRSAD5-74-2472SS.....	115
WR63-1236S - WR63-1272S-5.....	107	WR74-2136SG-5 - WR74-2172SG-5.....	113	WR86-1836SG-5 - WR86-1872SG-5.....	113	.....	.....	.....	.....	WRSAD5-74-2472SS.....	115
WR63-1424BK - WR63-1472BK-5.....	107	WR74-2424BK - WR74-2472BK-5.....	108	WR86-1836SG-5 - WR86-1872SG-5.....	113	.....	.....	.....	.....	WRSAD5-74-2472SS.....	115
WR63-1424C - WR63-1472C-5.....	108	WR74-2424C - WR74-2472C-5.....	108	WR86-1836SG-5 - WR86-1872SG-5.....	113	.....	.....	.....	.....	WRSAD5-74-2472SS.....	115
WR63-1424GY - WR63-1472GY-5.....	107	WR74-2424G - WR74-2472G-5.....	108	WR86-1836SG-5 - WR86-1872SG-5.....	113	.....	.....	.....	.....	WRSAD5-74-2472SS.....	115
WR63-1424P - WR63-1472P-5.....	107	WR74-2424P - WR74-2472P-5.....	108	WR86-1836SG-5 - WR86-1872SG-5.....	113	.....	.....	.....	.....	WRSAD5-74-2472SS.....	115
WR63-1424WPM - WR63-2472WPM.....	117	WR74-2424S - WR74-2472S-5.....	108	WR86-1836SG-5 - WR86-1872SG-5.....	113	.....	.....	.....	.....	WRSAD5-74-2472SS.....	115
WR63-1424WPM5 - WR63-2472WPM5.....	117	WR74-2424WPM - WR74-2472WPM-5.....	117	WR86-1836SG-5 - WR86-1872SG-5.....	113	.....	.....	.....	.....	WRSAD5-74-2472SS.....	115
WR63-1430S - WR63-1472S-5.....	107	WR74-2424WPM5 - WR74-2472WPM5-5.....	117	WR86-1836SG-5 - WR86-1872SG-5.....	113	.....	.....	.....	.....	WRSAD5-74-2472SS.....	115
WR63-1436SG - WR63-1472SG.....	112	WR74-2436C - WR74-2472C-5.....	108	WR86-1836SG-5 - WR86-1872SG-5.....	113	.....	.....	.....	.....	WRSAD5-74-2472SS.....	115
WR63-1436SG-5 - WR63-1472SG-5.....	113	WR74-2436G - WR74-2472G-5.....	108	WR86-1836SG-5 - WR86-1872SG-5.....	113	.....	.....	.....	.....	WRSAD5-74-2472SS.....	115
WR63-1824BK - WR63-1872BK-5.....	107	WR74-2436P - WR74-2472P-5.....	108	WR86-1836SG-5 - WR86-1872SG-5.....	113	.....	.....	.....	.....	WRSAD5-74-2472SS.....	115
WR63-1824C - WR63-1872C-5.....	107	WR74-2436S - WR74-2472S-5.....	107	WR86-1836SG-5 - WR86-1872SG-5.....	113	.....	.....	.....	.....	WRSAD5-74-2472SS.....	115
WR63-1824GY - WR63-1872GY-5.....	107	WR74-2442CRNC - WR74-2442CRNP-5.....	120	WR86-1836SG-5 - WR86-1872SG-5.....	113	.....	.....	.....	.....	WRSAD5-74-2472SS.....	115
WR63-1824P - WR63-1872P-5.....	107	WR74-2448-105106.....	54	WR86-1836SG-5 - WR86-1872SG-5.....	113	.....	.....	.....	.....	WRSAD5-74-2472SS.....	115
WR63-1824S - WR63-1872S-5.....	107	WR74-2448-66106.....	54	WR86-1836SG-5 - WR86-1872SG-5.....	113	.....	.....	.....	.....	WRSAD5-74-2472SS.....	

# REVOLUTIONIZE THE WAY YOU ORGANIZE!



## CORPORATE OFFICE

T: **800-685-4665**

P: 305-687-0405

F: 305-688-2790

sales@quantumstorage.com

15800 NW 15th Avenue

Miami, FL 33169



TO VIEW OUR FULL PRODUCT LINE

**VISIT US  
ONLINE**



QuantumStorage.com

## MIDWEST DISTRIBUTION CENTER

2600 United Lane

Elk Grove Village, IL 60007

Toll Free **1-800-685-4665**

Phone 305-687-0405

Fax 305-688-2790

sales@quantumstorage.com

## CANADA DISTRIBUTION CENTER

1624 Concession Road

Cambridge, Ontario N3H 4L9

Toll Free **1-888-653-8848**

Phone 519-653-8848

Fax 519-653-7989

quantumstorage@bellnet.ca



FACEBOOK

@QUANTUMSTORAGESYSTEMS



INSTAGRAM

@QUANTUMSTORAGESYSTEMS



LINKEDIN

QUANTUM STORAGE SYSTEMS



YOUTUBE

@QUANTUMSTORAGE3815